

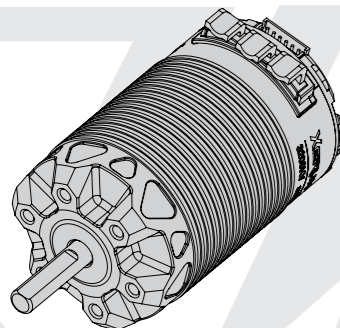

Thank you for purchasing this HOBBYWING product! Please read this declaration carefully before use, once you use the product, we will assume that you have read and agreed with all the content. Brushless power systems can be very dangerous and any improper use may cause personal injury and damage to the product and related devices, so please strictly follow the instruction during installation and use. Because we have no control over the use, installation, or maintenance of this product, no liability may be assumed for any damages or losses resulting from the use of the product. We do not assume responsibility for any losses caused by unauthorized modifications to our product. We have the right to modify our product design, appearance, features and usage requirements without notification. We, HOBBYWING, are only responsible for our product cost and nothing else as result of using our product. Regarding the possible semantic different between two different versions of declaration, for users in mainland China, please take standard.



XERUN
USER MANUAL
Sensored Brushless Motor
XERUN 3652 G3
XERUN 3660 G3

20240815

HW-SMB569DUL00

01 Warnings

- Read the manuals of all the items being used in the build. Ensure gearing, setup, and overall install is correct and reasonable.
- It is important to ensure that all wires & connectors soldered are properly secured to avoid short circuits from happening. A good soldering station is recommended to do such a job to ensure connections are properly soldered.
- Never apply full throttle if the pinion is not connected to the drive train. Due to the extremely high RPMs without load, the motor may get damaged.
- Do not let the external temperature of the system exceed 100°C/212°F, high temperature will damage the motor and cause the rotor to weaken.

02 Features

- High efficiency, efficient cooling, and the motor always in a safe state.
- The mechanical timing of motor can be adjusted from 20-40°, it is convenient for driver to tune the response of motor and meet power requirements of various application.
- The motor has no cogging effect and is very smooth at low speed.
- IP5X grade protection. Its excellent dustproof performance can easily deal with various dusty track environment.
- Dual sensor ports to meet various wiring/layout requirements.
- Larger more robust copper termination parts provide improved power delivery and consistency.

03 Specifications

Model	KV	LiPos	No-load Current (A)	Diameter/Length (mm)	Shaft Diameter/Length (mm)	Bearing size (mm)	Poles	Weight (g)	Applications
XERUN 3652SD-5300KV-G3	5300KV	2S	7.5A	φ=36.6 mm(1.44") L=53 mm(2.09")	φ=5mm(1/5") L=15mm(0.59")	Front: D13*D5*T4 Rear: D11*D5*T5	4	194g	1/10 Short course car (2WD), Buggy, Rally
XERUN 3652SD-4500KV-G3	4500KV		6.1A					189g	
XERUN 3660SD-4200KV-G3	4200KV	2-3S	5.7A	φ=36.6 mm(1.44") L=60.1 mm(2.37")	φ=5mm(1/5") L=18.5mm(0.73")			230g	1/10 Short course car (4WD), Truck, Monster truck
XERUN 3660SD-3200KV-G3	3200KV		4.4A					227g	

XERUN 3652SD G3

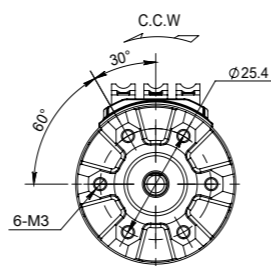
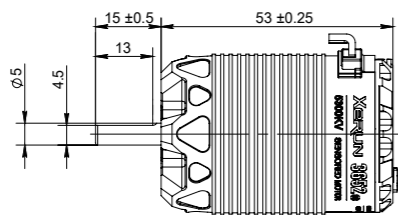
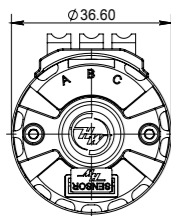

XERUN 3660SD G3

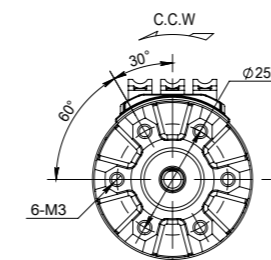
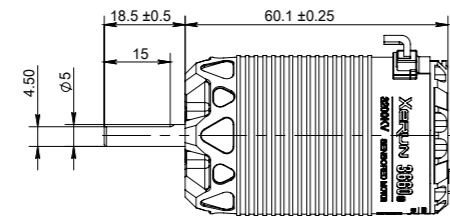
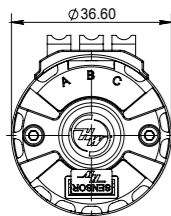

04 Installation & Connection

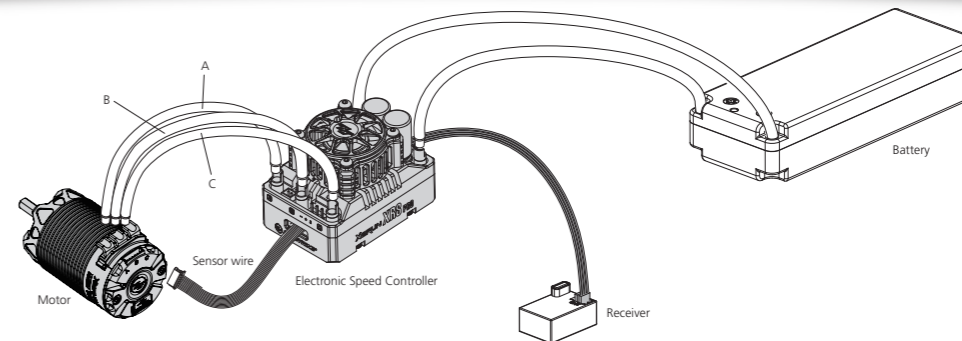

1. Installation of the motor

There are 6 motor mounting holes in M3 specification, and the mounting holes are 5mm in depth, before installing the motor on the vehicle, please carefully confirm whether the length of the screws is appropriate, so not to damage the motor due to excessive length.

2. How to Connect the Motor to an ESC

When connecting the motor and esc, please pay attention to the marked three-phase position of A, B and C to ensure that the three wires of the motor and esc are connected in the order that, wire A of the esc matches wire A of the motor, wire B of the esc matches wire B of the motor, wire C of the esc matches wire C of the motor. Otherwise, it cannot run and may even damage the esc and motor. And then connect the sensor cable to the motor and ESC.

3. Inspection

Before powering on the esc, please check the motor installation and the order of all connections.

05 Timing Adjustment

1. With the motor direction set to CCW, take the value after "CCW" on the motor case as the starting point when adjusting the timing. With the reversed triangle pointing at a value, the smaller/bigger the value, the smaller/bigger the timing. The timing is 40 degrees in picture 1.
2. With the motor direction set to CW, take the value after "CW" on the motor case as the starting point when adjusting the timing. (With the reversed triangle pointing at a value, the smaller/bigger the value, the smaller/bigger the timing. The timing is 20 degrees in picture 1.
3. The motor timing is 30 degrees by default (as shown in picture 2). The motor timing should be within 30 to 40 degrees if you want to activate the Turbo timing. And the timing can be within 20 to 40 degrees if you have no intention to activate the Turbo timing.

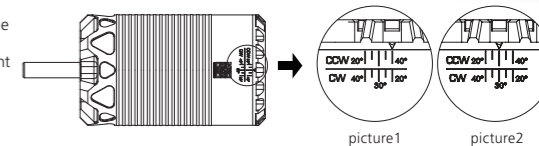

06 Gearing

Correct and safe gear ratio is very important. Improper gear ratio will cause damage. You can select the gear ratio according to the following points!

1. The operating temperature of the motor

The motor temperature not exceed 100 degrees Celsius (212 degrees Fahrenheit) in operation. High temperature may cause the magnets to get demagnetized, the coil to short circuit, and damage to the ESC. Proper safe gearing will prevent the motor from overheating.

2. The principle of selecting gear ratio

To avoid the possible damage to ESC and motor caused by the overheating, please start with a small pinion/a big FDR and check the motor temperature regularly. If the motor and ESC temperature stays at a low level during the operation, you can change a larger pinion/a lower FDR and also check the motor temperature regularly to ensure that the new FDR is suitable for your vehicle, local weather and track condition. (Note: For the safety of electric devices, please check the ESC and motor temperature regularly.)

07 Assembly and Disassembly

In order for the motor have longer service life and higher efficiency, we suggest to regularly check the bearing and clean the dirt in the motor. The specific time depends on the frequency of using the motor and the site conditions. When installing, please follow the steps in the following assembly drawing; when disassembling, follow the reverse steps.

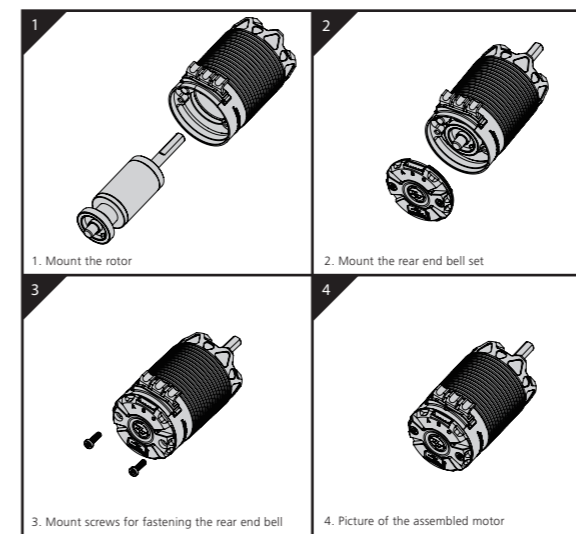

Parts List

