

# DECATHLON

MS:30

## ASSEMBLY MANUAL



### SPECIFICATIONS:

|                    |                                       |                |
|--------------------|---------------------------------------|----------------|
| WING SPAN          | -----172CM                            | -----67.75 in. |
| WING AREA          | -----49.17Sq.dm                       | -----762Sq.in. |
| WEIGHT             | -----3.17 - 3.62KG                    | -----7- 8lbs.  |
| ENGINE SIZE        | -----.40 - .46 cu. in                 | -----2-stroke. |
|                    | ----- .50 - .72 cu. in                | -----4-stroke. |
| RECOMMENDED R/C    | -----4 CHANNEL MINIMUM WITH 6 SERVOS. |                |
| FLYING SKILL LEVEL | -----ADVANCED / INTERMEDIATE.         |                |
| LENGTH             | -----127CM                            | -----50in.     |

### Kit features

- Ready-made-minimal assembly & finishing required.
- Ready-covered covering.
- Factory-installed pushrods.
- Factory-installed engine mount.
- Comprehensive hardware pack including wheels, tank, spats, undercarriage & spinner.
- Photo-illustrated step-by-step Assembly Manual.

Made in Vietnam.

## INTRODUCTION

Thank you for choosing the **DECATHLON** ARTF by SG MODELS. The **DECATHLON** was designed with the intermediate/advanced sport flyer in mind. It is a semi scale airplane which is easy to fly and quick to assemble. The airframe is conventionally built using balsa, plywood and veneer to make it stronger than the average ARTF, yet the design allows the aeroplane to be kept light. You will find that most of the work has been done for you already. The pushrods are pre-made to the correct lengths, the motor mount has been fitted and the hinges are pre-installed and pinned for security. Flying the **DECATHLON** is simply a joy.

This instruction manual is designed to help you build a great flying aeroplane. Please read this manual thoroughly before starting assembly of your **DECATHLON**. Use the parts listing below to identify all parts.

## WARNING

***Please be aware that this aeroplane is not a toy and if assembled or used incorrectly it is capable of causing injury to people or property. WHEN YOU FLY THIS AEROPLANE YOU ASSUME ALL RISK & RESPONSIBILITY.***

If you are inexperienced with basic R/C flight we strongly recommend you contact your R/C supplier and join your local R/C Model Flying Club. R/C Model Flying Clubs offer a variety of training procedures designed to help the new pilot on his way to successful R/C flight. They will also be able to advise on any insurance and safety regulations that may apply.

## ADDITIONAL ITEMS REQUIRED

- .40-.46 2-stroke engine.
- .50-.72 4-stroke engine.
- Computer radio with six servos.
- Glow plug to suit engine.
- Propeller to suit engine.
- Protective foam rubber for radio system.
- Silicone fuel line.

## TOOLS & SUPPLIES NEEDED

- Thick cyanoacrylate glue.
- 30 minute epoxy.
- 5 minute epoxy.
- Hand or electric drill.
- Assorted drill bits.
- Modelling knife.
- Straight edge ruler.
- 2mm ball driver.
- Phillips head screwdriver.
- 220 grit sandpaper.
- 90° square or builder's triangle.
- Wire cutters.
- Masking tape & T-pins.
- Thread-lock.
- Paper towels.

## PARTS LISTING

### FUSELAGE ASSEMBLY

- (1) Fuselage.

### WING ASSEMBLY

- (1) Right wing half with pre-installed aileron.
- (1) Left wing half with pre-installed aileron.
- (1) Plywood wing dihedral brace.
- (1) Covering strip for centre section joint.

### Tail section assembly

- (1) Vertical stabilizer with pre-installed rudder.
- (1) Horizontal stabilizer with pre-installed elevator halves.

Some more parts.

### HARDWARE PACK

COWLING.  
Landing gear.....

**NOTE:** To avoid scratching your new aeroplane we suggest that you cover your workbench with an old towel. Keep a couple of jars or bowls handy to hold the small parts after you open the bags.

Please trial fit all parts. Make sure you have the correct parts and that they fit and are aligned properly before gluing! This will ensure proper assembly as the **DECATHLON** is made from natural materials and minor adjustments may have to be made.

The paint and plastic parts used in this kit are fuel proof. However, they are not tolerant of many harsh chemicals including the following: paint thinner, cyano-acrylate glue accelerator, cyanoacrylate glue de-bonder and acetone. Do not let these chemicals come in contact with the colours on the covering and the plastic parts.



### HINGING THE AILERONS

**Note:** The control surfaces, including the ailerons, elevators, and rudder, are prehinged with hinges installed, but the hinges are not glued in place. It is imperative that you properly adhere the hinges in place per the steps that follow using a high-quality thin CA glue.

□ 1) Carefully remove the aileron from one of the wing panels. Note the position of the hinges.

□ 2) Remove each hinge from the wing panel and aileron and place a T-pin in the center of each hinge. Slide each hinge into the aileron until the T-pin is snug against the aileron. This will help ensure an equal amount of hinge is on either side of the hinge line when the aileron is mounted to the wing panel.

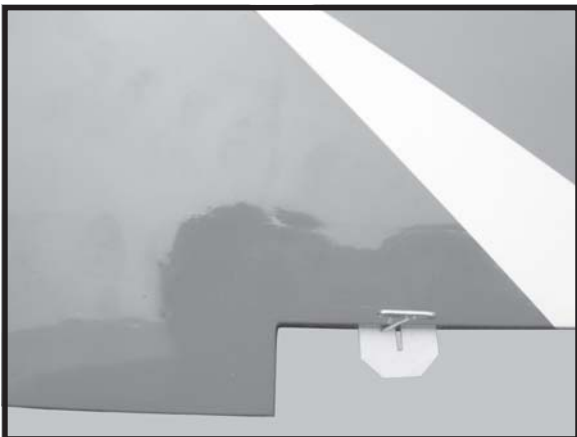

□ 3) Slide the aileron on the wing panel until there is only a slight gap. The hinge is now centered on the wing panel and aileron. Remove the T-pins and snug the aileron against the wing panel. A gap of 1/64" or less should be maintained between the wing panel and aileron.

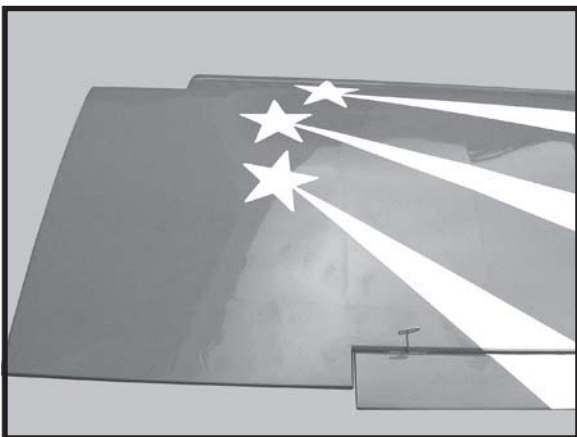

□ 4) Deflect the aileron and completely saturate each hinge with thin CA glue. The ailerons front surface should lightly contact the wing during this procedure. Ideally, when the hinges are glued in place, a 1/64" gap or less will be maintained throughout the length of the aileron to the wing panel hinge line.

**Note:** The hinge is constructed of a special material that allows the CA to wick or penetrate and distribute throughout the hinge, securely bonding it to the wood structure of the wing panel and aileron.

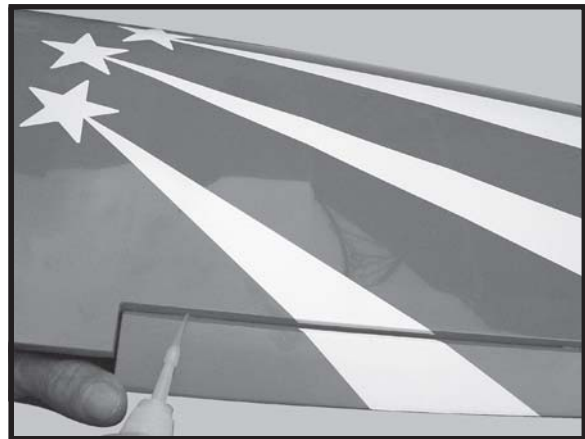

□ 5) Turn the wing panel over and deflect the aileron in the opposite direction from the opposite side. Apply thin CA glue to each hinge, making sure that the CA penetrates into both the aileron and wing panel.

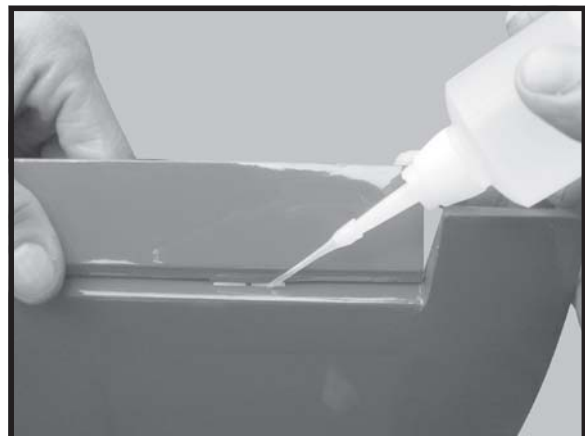

□ 6) Using CA remover/debonder and a paper towel, remove any excess CA glue that may have accumulated on the wing or in the aileron hinge area.

- 7) Repeat this process with the other wing panel, securely hinging the aileron in place.
- 8) After both ailerons are securely hinged, firmly grasp the wing panel and aileron to make sure the hinges are securely glued and cannot be pulled out. Do this by carefully applying medium pressure, trying to separate the aileron from the wing panel. Use caution not to crush the wing structure.

**Note:** Work the aileron up and down several times to “work in” the hinges and check for proper movement.

### HINGING THE ELEVATORS

- 1) Carefully remove the elevator from one of the horizontal stabilizer panels. Note the position of the hinges.
- 2) Remove each hinge from the horizontal stabilizer panel and elevator and place a T-pin in the center of each hinge. Slide each hinge into the elevator until the T-pin is snug against the elevator. This will help ensure an equal amount of hinge is on either side of the hinge line when the elevator is mounted to the horizontal stabilizer panel.

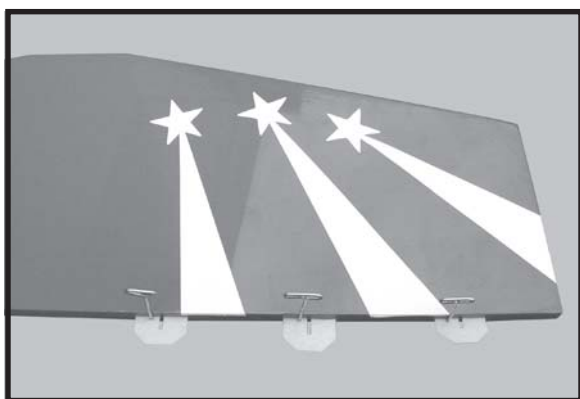

- 3) Slide the elevator on the horizontal stabilizer panel until there is only a slight gap. The hinge is now centered on the horizontal stabilizer panel and elevator. Remove the T-pins and snug the elevator against the horizontal stabilizer panel. A gap of 1/64” or less should be maintained between the horizontal stabilizer panel and elevator.

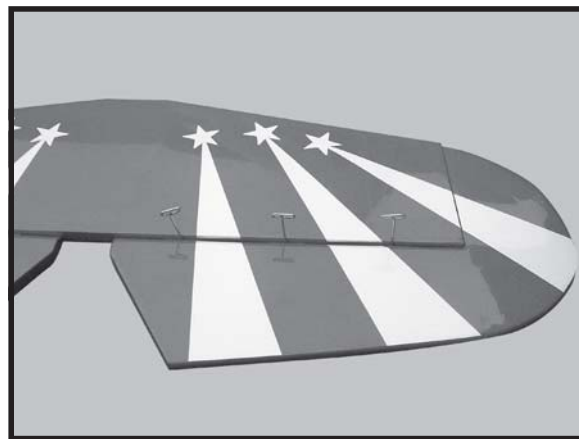

- 4) Deflect the elevator and completely saturate each hinge with thin CA glue. The elevators front surface should lightly contact the horizontal stabilizer during this procedure. Ideally, when the hinges are glued in place, a 1/64” gap or less will be maintained throughout the length of the elevator to the horizontal stabilizer panel hinge line.

**Note:** The hinge is constructed of a special material that allows the CA to wick or penetrate and distribute throughout the hinge, securely bonding it to the wood structure of the horizontal stabilizer panel and elevator.



- 5) Turn the horizontal stabilizer panel over and deflect the elevator in the opposite direction from the opposite side. Apply thin CA glue to each hinge, making sure that the CA penetrates into both the elevator and horizontal stabilizer panel.

□ 6) Using CA remover/debonder and a paper towel, remove any excess CA glue that may have accumulated on the horizontal stabilizer or in the elevator hinge area.

□ 7) Repeat this process with the other horizontal stabilizer panel, securely hinging the elevator in place.

□ 8) After both horizontal stabilizer are securely hinged, firmly grasp the horizontal stabilizer panel and elevator to make sure the hinges are securely glued and cannot be pulled out. Do this by carefully applying medium pressure, trying to separate the elevator from the horizontal stabilizer panel. Use caution not to crush the horizontal stabilizer structure.

### HINGING THE RUDDER

□ 1) Carefully remove the rudder from one of the vertical stabilizer panel. Note the position of the hinges.

□ 2) Remove each hinge from the vertical stabilizer panel and rudder and place a T-pin in the center of each hinge. Slide each hinge into the rudder until the T-pin is snug against the rudder. This will help ensure an equal amount of hinge is on either side of the hinge line when the rudder is mounted to the vertical stabilizer.

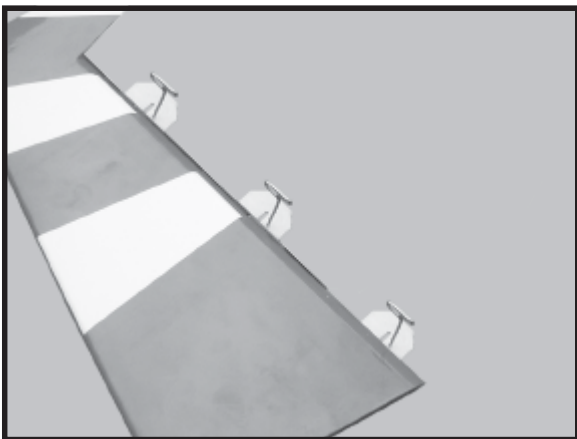

□ 3) Slide the rudder on the vertical stabilizer panel until there is only a slight gap. The hinge is now centered on the vertical stabilizer panel and rudder. Remove the T-pins and snug the rudder against the vertical stabilizer panel. A gap of 1/64" or less should be maintained between the vertical stabilizer panel and rudder.

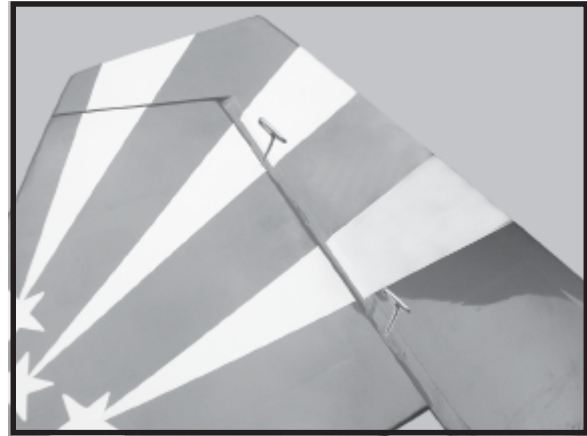

□ 4) Deflect the rudder and completely saturate each hinge with thin CA glue. The rudder front surface should lightly contact the vertical stabilizer during this procedure. Ideally, when the hinges are glued in place, a 1/64" gap or less will be maintained throughout the length of the rudder to the vertical stabilizer panel hinge line.

**Note:** The hinge is constructed of a special material that allows the CA to wick or penetrate and distribute throughout the hinge, securely bonding it to the wood structure of the vertical stabilizer panel and rudder.

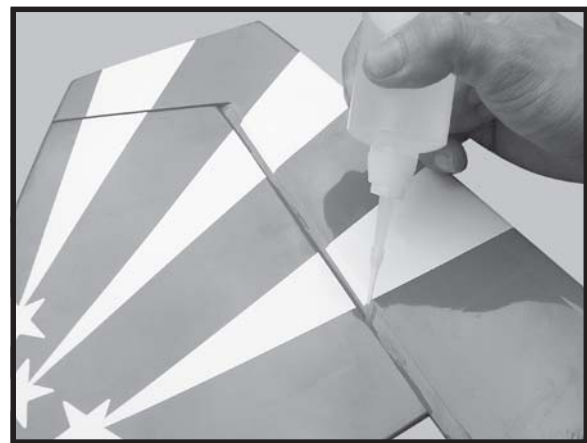

□ 5) Turn the vertical stabilizer panel over and deflect the rudder in the opposite direction from the opposite side. Apply thin CA glue to each hinge, making sure that the CA penetrates into the rudder and vertical stabilizer panel.

□ 6) Using CA remover/debonder and a paper towel, remove any excess CA glue that may have accumulated on the vertical stabilizer or in the rudder hinge area.

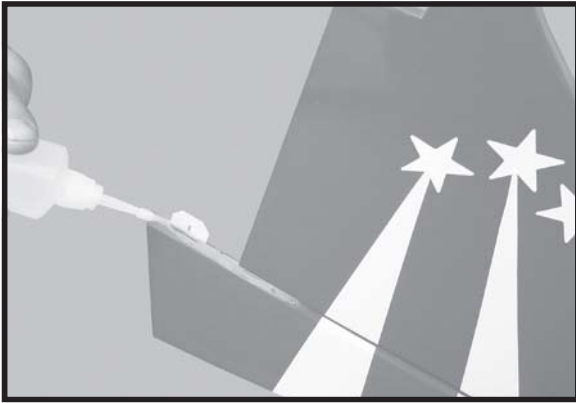

**Note:** Work the rudder up and down several times to “work in” the hinges and check for proper movement.

**WING ASSEMBLY.**

**NOTE:** *We highly recommend using 30 minute epoxy as it is stronger and provides more working time, allowing the builder to properly align the parts. Using fast cure epoxy when joining the wing halves could result in the glue drying before the wing halves are aligned properly which may result in failure of the wing centre section during flight.*

□ 1) Test fit the wing tube into each wing half. The brace should slide in easily up to the centreline that you drew. If not, use 220 grit sandpaper with a sanding block and sand down the edges and ends of the brace until it fits properly.

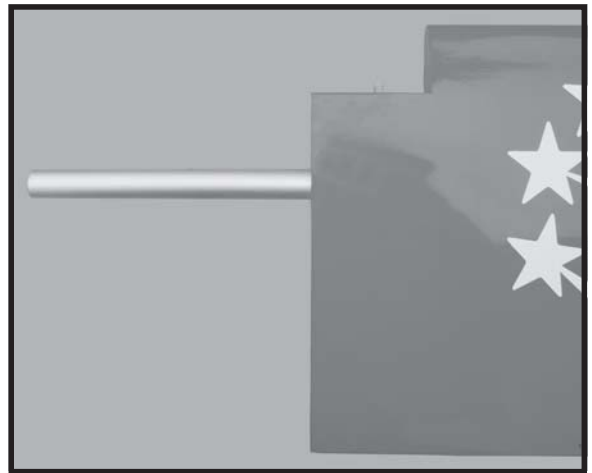
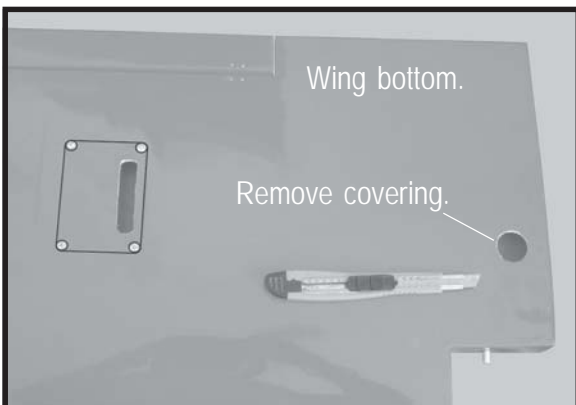
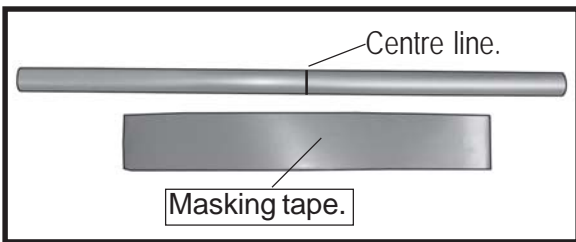

□ 2) Remove the brace when satisfied with its fit in each wing half. Coat both sides of one half of the dihedral brace with 30 minute epoxy. Next, pour some epoxy into the dihedral box in one wing panel. Make sure you cover the top and bottom as well as the sides of the dihedral brace. Use enough epoxy to fill any gaps.

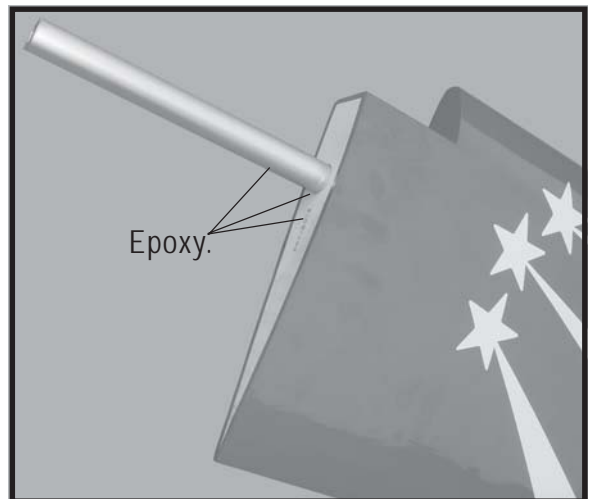

Carefully slide the two wing halves together and firmly press them together, allowing the excess epoxy to run out. There should not be any gap in the wing halves. Use rubbing alcohol and a paper towel to clean up any excess epoxy.

Apply masking tape at the wing join to hold the wing halves together securely.

□ 3) Peel off the backing from the self adhesive covering strip. Apply the strip to the centre section of the wing starting from the bottom trailing edge. Wrap the strip all the way around the wing until it meets the trailing edge again. Trim off any excess strip.

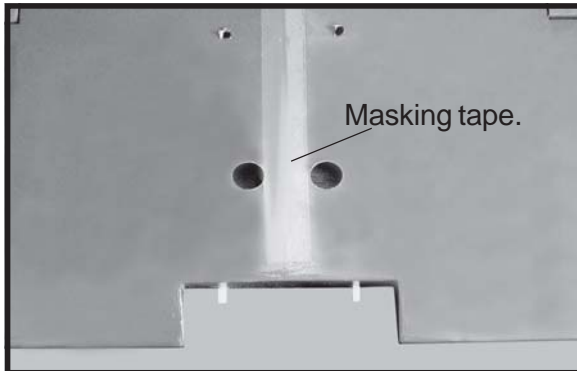
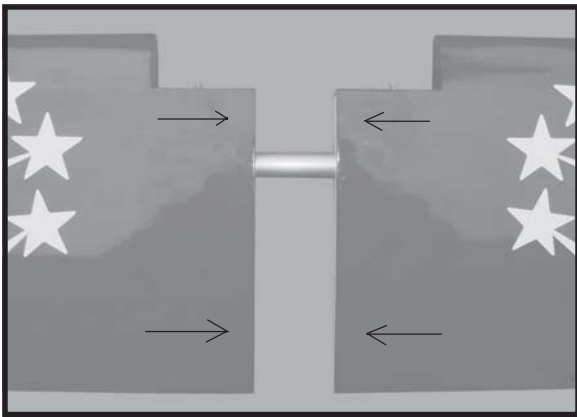

**INSTALLING THE AILERON SERVOS.**

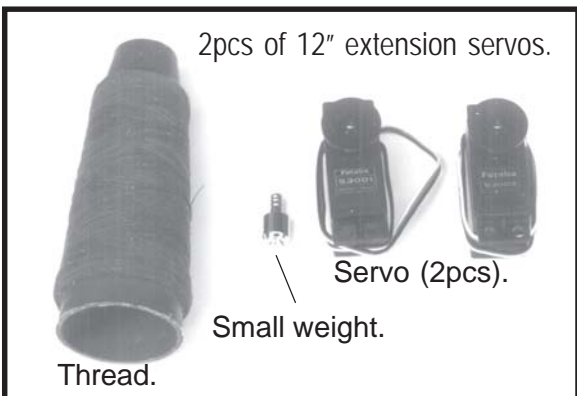

❑ 1) Remove servo tray from the each panel of wing. Install servo and servo arm. See pictures below.



❑ 2) Install the rubber grommets and brass collets onto the aileron servo. Test fit the servo into the aileron servo mount.

**!** Because the size of servos differ, you may need to adjust the size of the precut opening in the mount. The notch in the sides of the mount allow the servo lead to pass through.

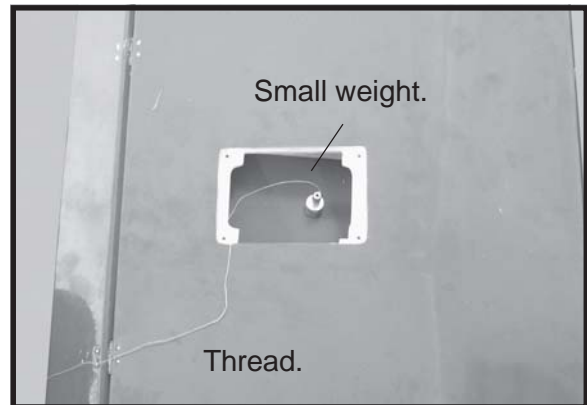

Use a small weight (Weighted fuel pick-up) and thread to feed the servo connector through the wing as shown.

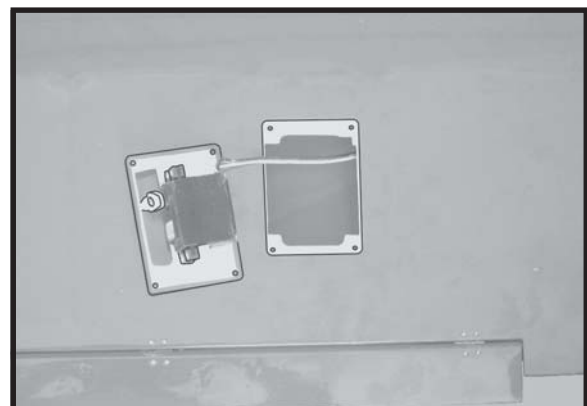

Attach the string to one end of servo lead and carefully thread it though the wing. Once you have thread the lead through the wing, remove the string and repeat for the other servo lead. Use masking tape to secure the leads to the wing and prevent them from falling back into the wing.

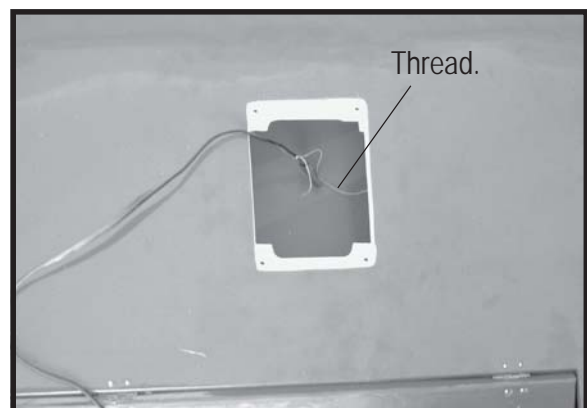



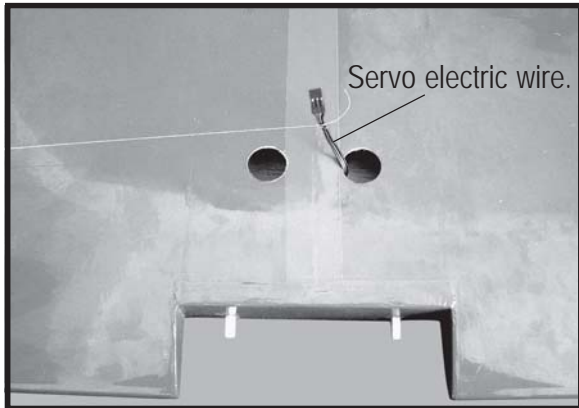
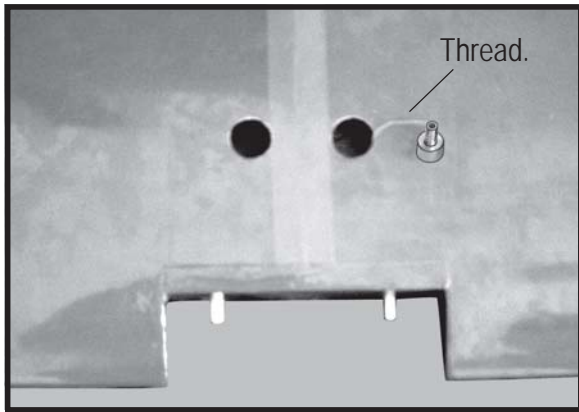

□ 3) Install the aileron servo tray into the servo mount.

**Repeat the procedure for the other wing half.**

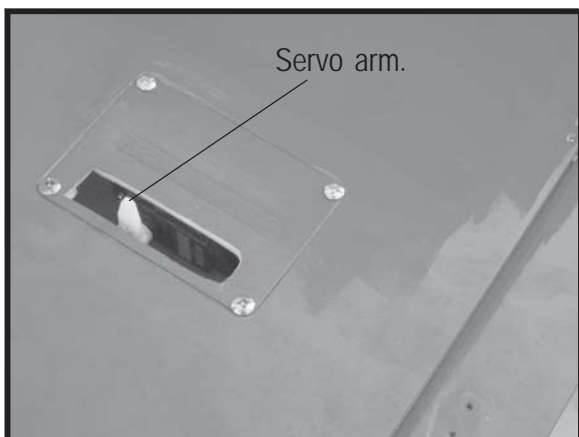
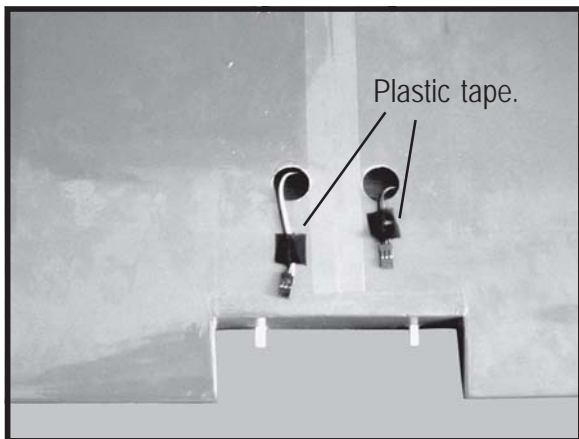

**INSTALLING THE AILERON LINKAGE**

□ 1) Using a ruler & pen to draw a straight line as below picture.

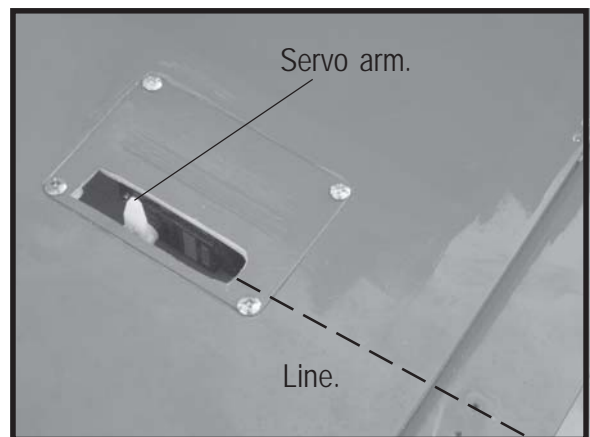
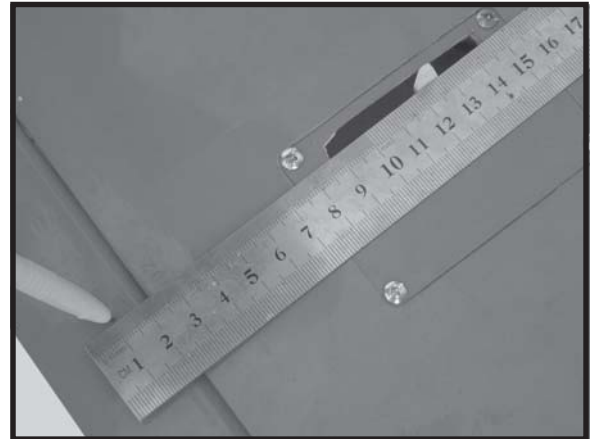

□ 2) Locate nylon control horns, nylon control horn backplates and 2 control horns bolts come with 2 nuts.

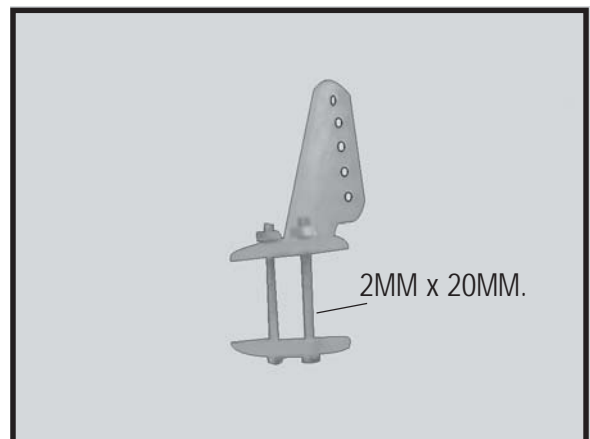

□ 3) Position the aileron horn on the bottom side of aileron. The clevis attachment holes should be positioned over the hinge line as shown below.

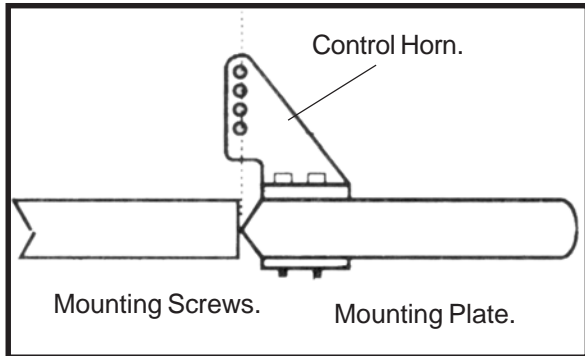

□ 4) Using a 1.5mm drill bit and the control horns as a guide, drill the mounting holes through the aileron halves.

□ 5) Mount the control horns by inserting the bolts through the control horn bases and aileron halves, then into the mounting backplates. Thread 2 nuts onto the bolt.

⚠ Do not overtighten the nut may crush the wood.

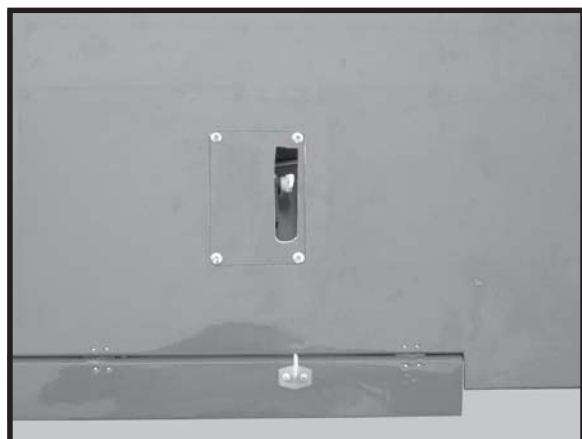
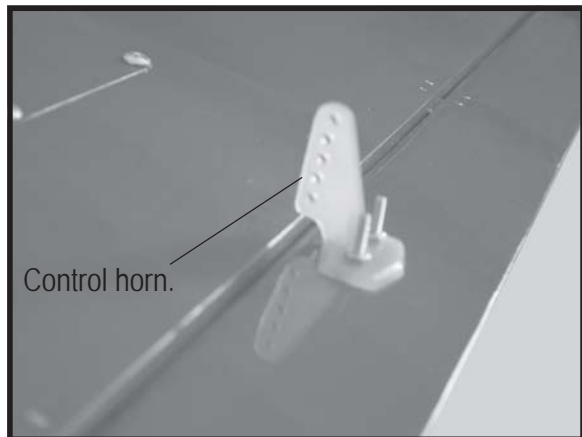

□ 6) Thread one clevis control horn onto each aileron torque rod. Thread the clevis on until they are flush with the ends of the torque rods.

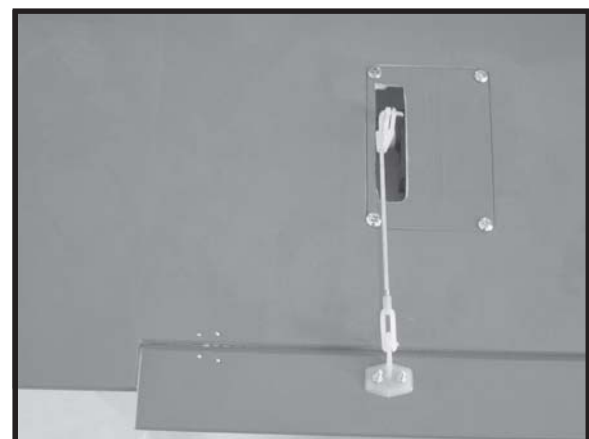
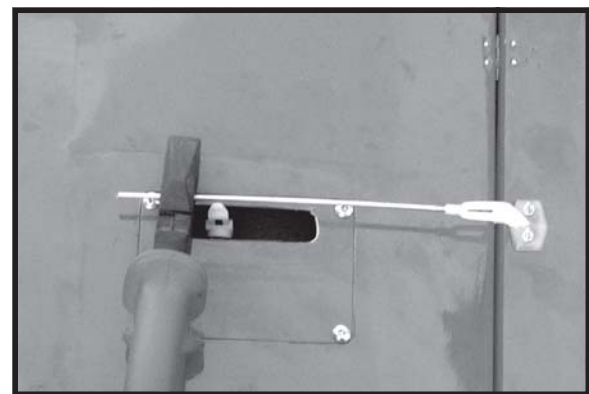
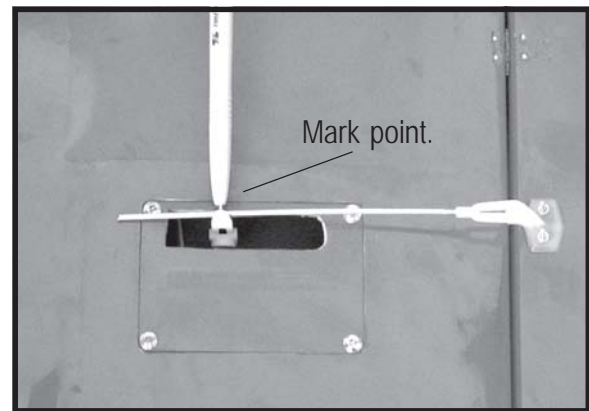
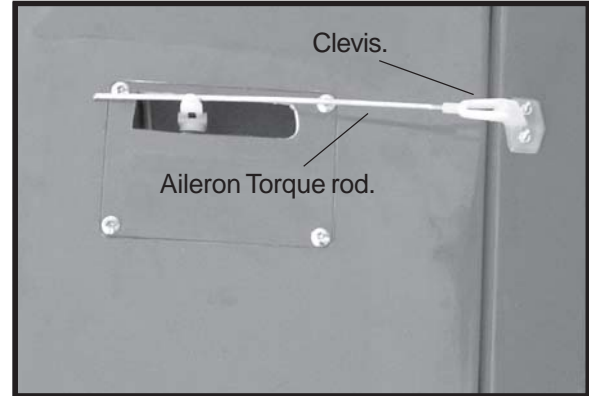

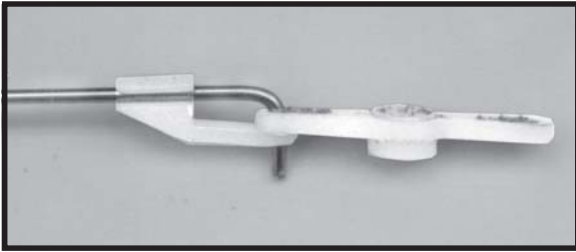

**FUEL TANK**

**PARTS REQUIRED**

- ☐ {1} Molded Nylon Fuel Tank
- ☐ {1} Preassembled Stopper Assembly
- ☐ {1} Metal Weighted Pick-Up
- ☐ {1} Silicon tube

**INSTALLING THE STOPPER ASSEMBLY**

- ☐ 1) Using a modeling knife, carefully cut off the rear portion of **one** of the 3 nylon tubes leaving 1/2" protruding from the rear of the stopper. This will be the fuel pick up tube.
- ☐ 2) Using a modeling knife, cut one length of silicon fuel line. Connect one end of the line to the weighted fuel pickup and the other end to the nylon pickup tube.
- ☐ 3) Carefully bend the second nylon tube up at a 45° angle. This tube is the vent tube. To set the angle of the vent tube use a lighter or heat gun to heat the tube (do not melt the tube).

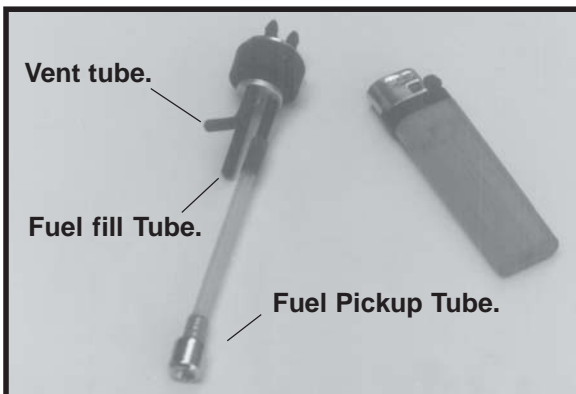

When the stopper assembly is installed in the tank, the top of the vent tube should rest just below the top surface of the tank. It should not touch the top of the tank.

- ☐ 4) Test fit the stopper assembly into the tank. It may be necessary to remove some of the flashing around the tank opening using a modeling knife. If flashing is present, make sure none falls into the tank.

- ☐ 5) With the stopper assembly in place, the weighted pickup should rest away from the rear of the tank and move freely inside the tank. The top of the vent tube should rest just below the top of the tank. It should not touch the top of the tank.

- ☐ 6) When satisfied with the alignment of the stopper assembly tighten the 3mm x 20mm machine screw until the rubber stopper expands and seals the tank opening. *Do not overtighten the assembly as this could cause the tank to split.*

Attach the silicone fuel, feed and pressure pipe to the tank. The lower pipe is the 'feed' and the upper is the 'pressure'. The silicone fuel pipe is the next of feed pipe.

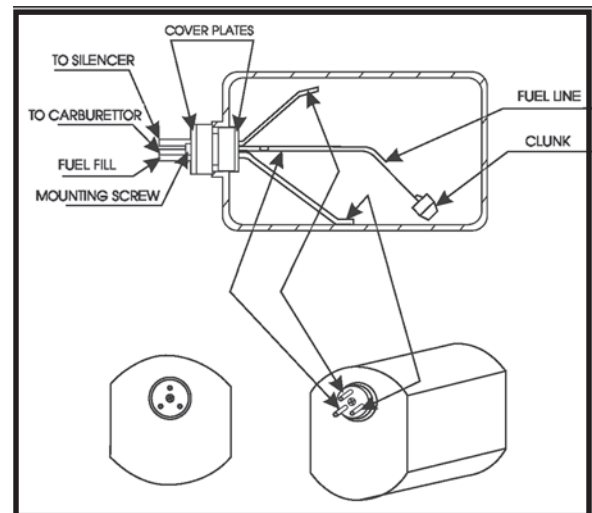

Slide the tank into the fuselage from inside so that the neck is at the top of the fuselage and it locates through the engine bulkhead. Gently secure it to the top horizontal former with the cable tie .

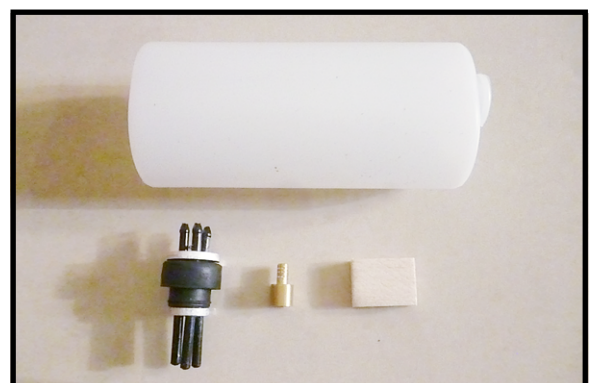

- ⚠ You should mark which tube is the vent and which is the fuel pickup when you attach fuel tubing to the tubes in the stopper. Once the tank is installed inside the fuselage, it may be difficult to determine each of them.

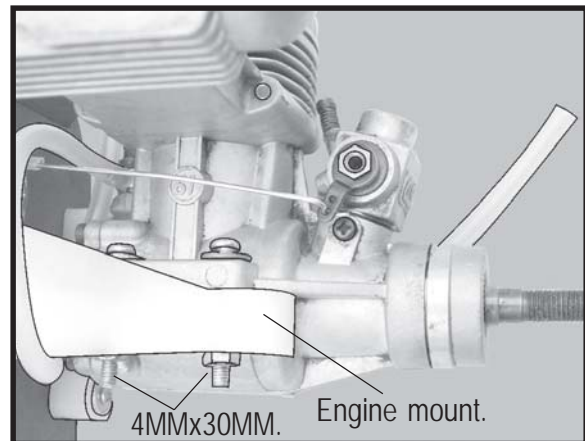
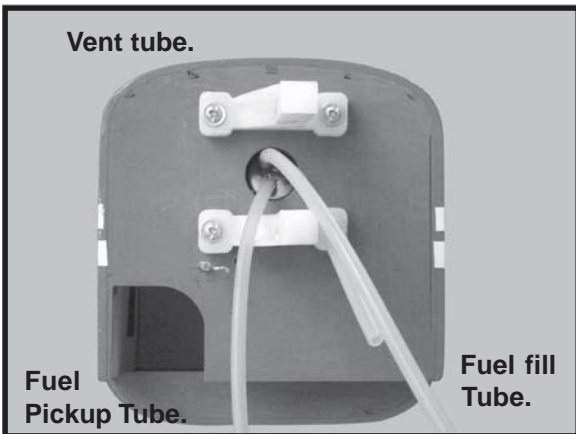
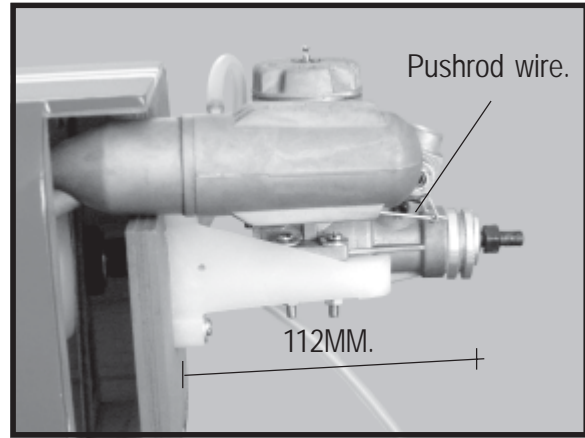
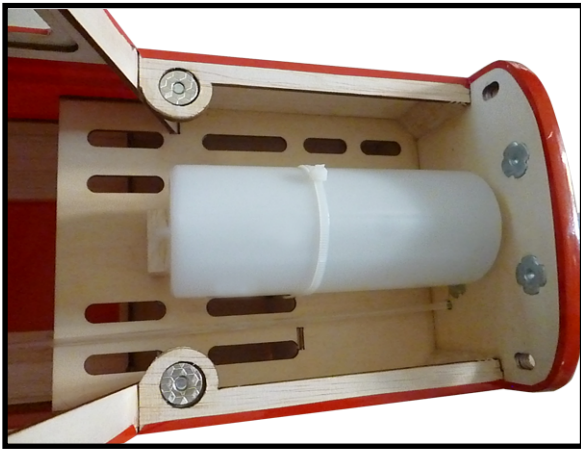

 Blow through one of the lines to ensure the fuel lines have not become kinked inside the fuel tank compartment. Air should flow through easily.

**MOUNTING THE ENGINE**

- 1) Trial fit your engine on the motor mount. The engine should be positioned so there is ample clearance in the cowling for spinner backplate mounted to the prop drive shaft.
- 2) Marking 4 points on the plastic motor mount.
- 3) Screw 4 pilot holes with 5 mm diameter.
- 4) Your engine on the motor mount by mounting with 4 bolts, 8 washers, and 4 nuts provided. A drop C/A glue on the bolt threads will help prevent loosening in flight.
- 5) Attach the Z-Bend in the pushrod wire to the throttle arm on the carburetor. You will need to remove the throttle arm from the carburetor to be able to attach the Z-bend. When complete, reattach the throttle arm to the carburetor.

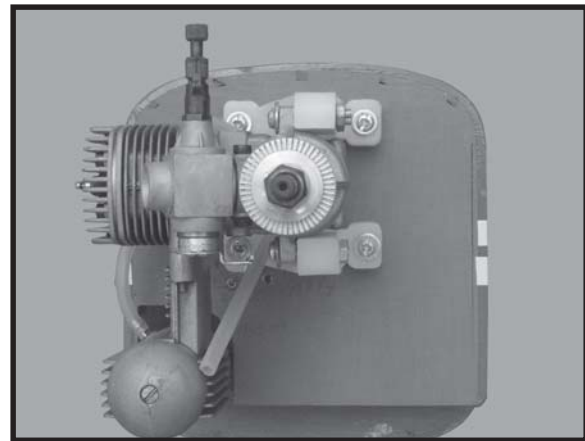

## ELECTRIC POWER CONVERSION.

1) Locate the items necessary to install the electric power conversion included with your model.

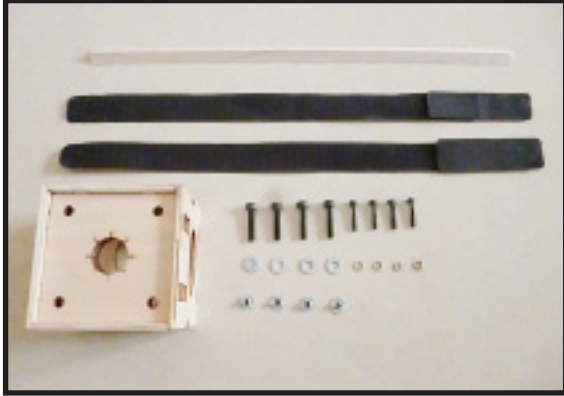

2) Recommend the items necessary to install the electric power conversion parts included with your model.

- **Motor: 46 - 925 Watts**
- **Propeller: 12x8 ~ 14x10**
- **ESC: 60A**
- **4S- 5S Lipo**

3) Attach the electric motor box to the firewall suitable with the cross lines drawn on the electric motor box and firewall. Using epoxy and balsa stick to secure the motor box to the firewall. Please see pictures below.

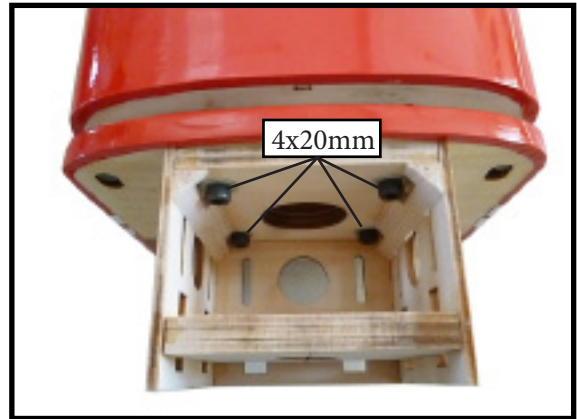

4) Attach the motor to the front of the electric motor box using four 4mm blind nut, four M3x15mm hex head bolts to secure the motor. Please see picture shown.

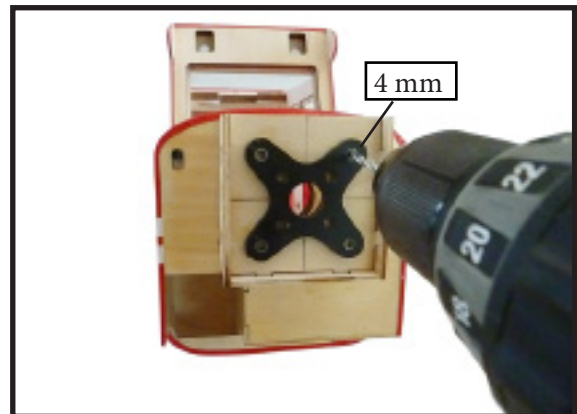

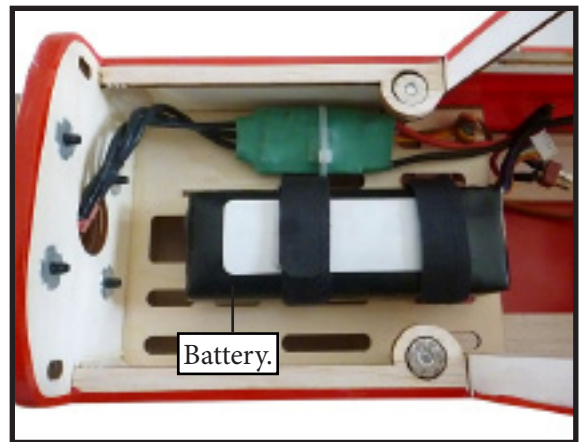
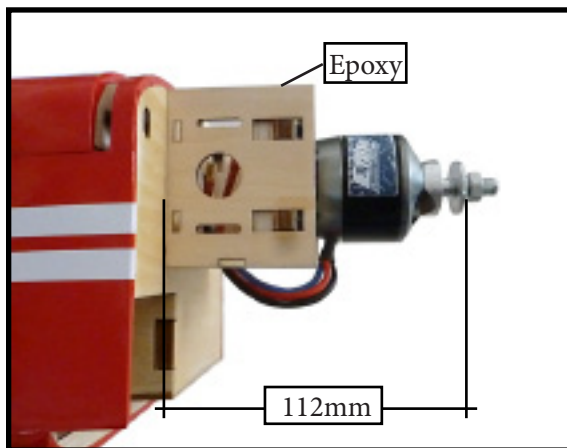
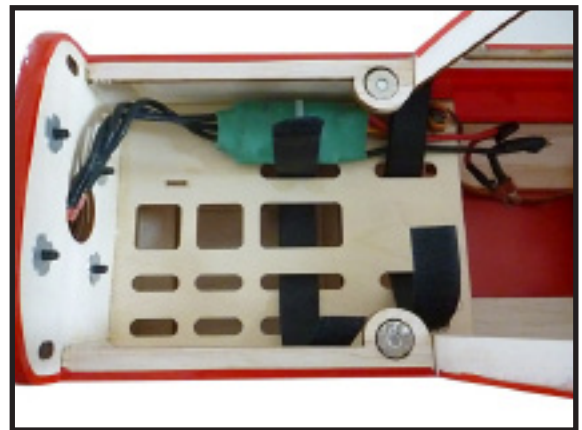
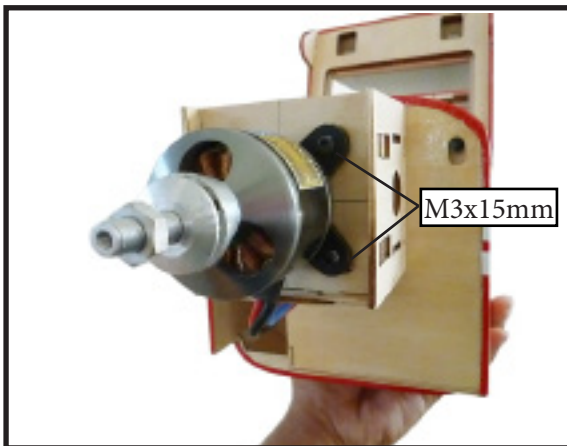
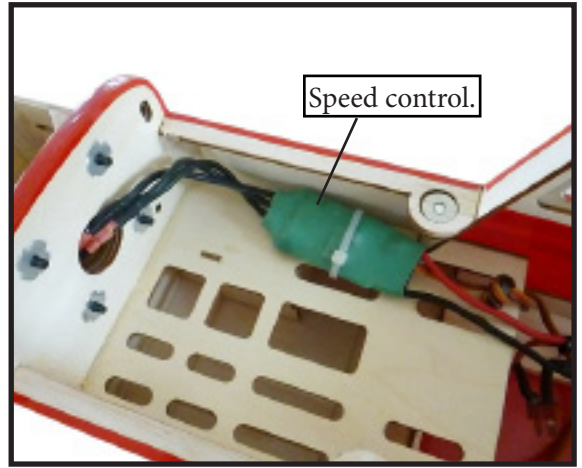
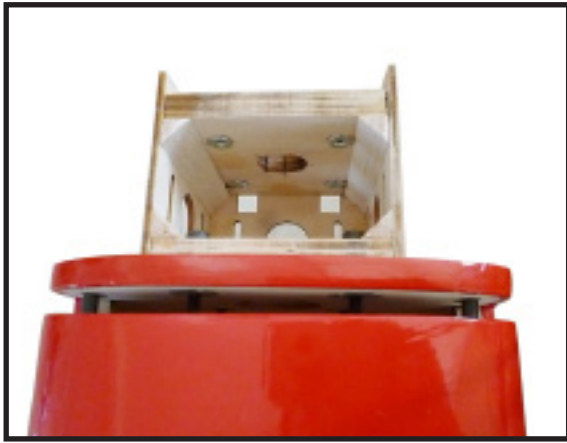

**WHEEL AND WHEEL PANTS.**

**PARTS REQUIRED**

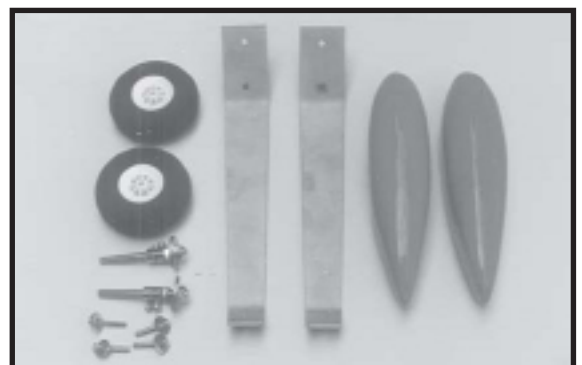
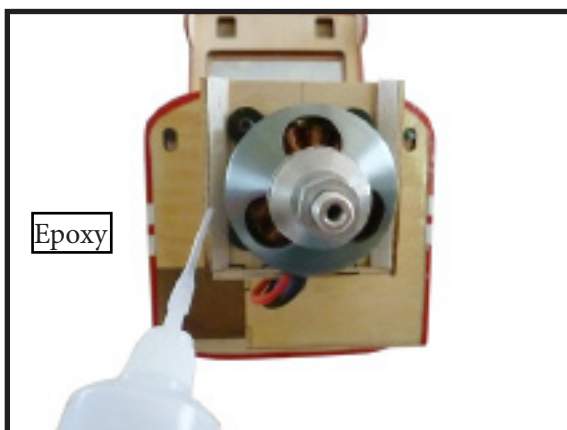

- 1) Assemble and mounting the wheel parts as shown in the following pictures.
- 2) Follow diagram below for wheel part installation:

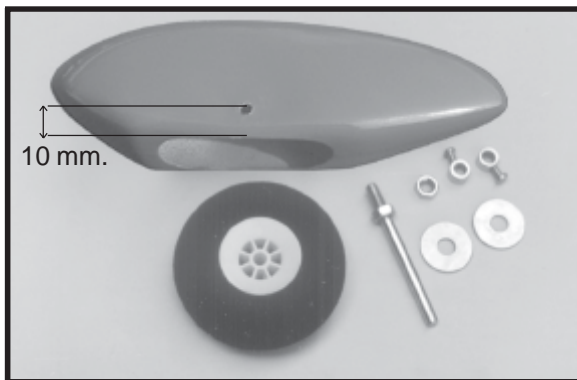
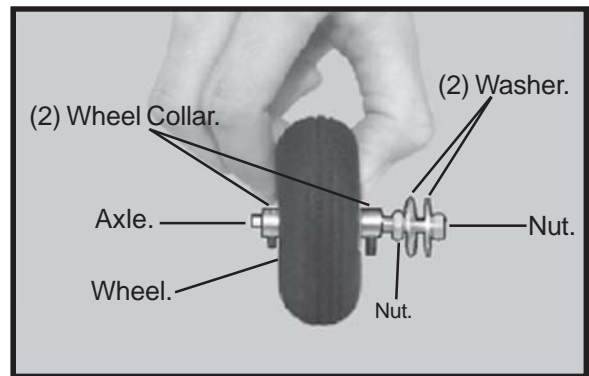
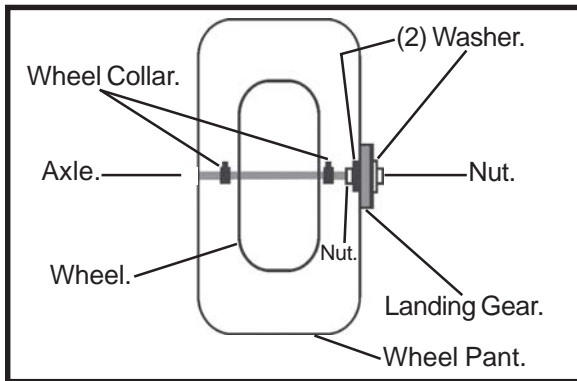

- 3) You have to trim each axle using a toll cutting and cut-off wheel.

 **Caution when cutting the axles and wear protective goggles.**

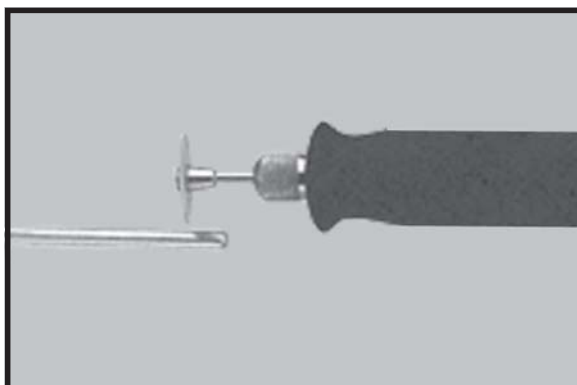
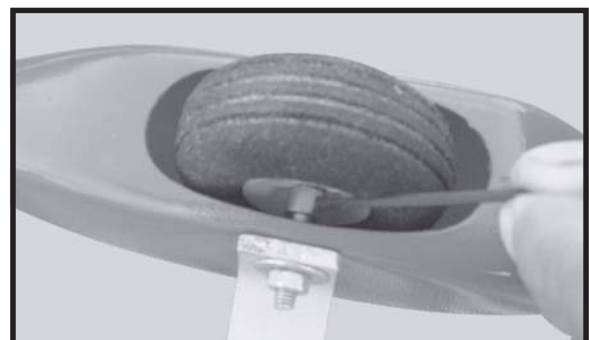
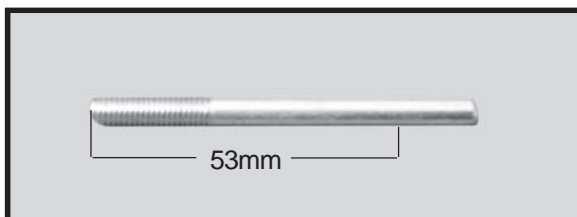
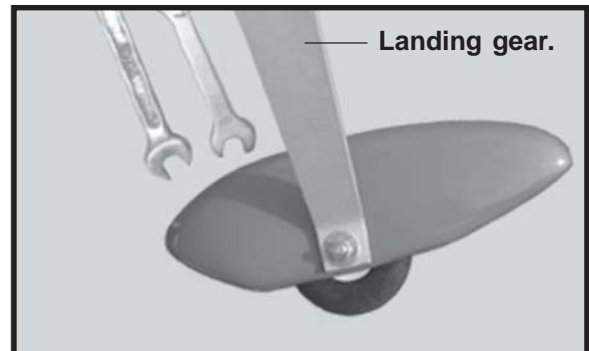

- 4) A drop of C/A glue on the wheel collar screws will help keep them from coming loose during operation. Repeat the process for the other wheel.

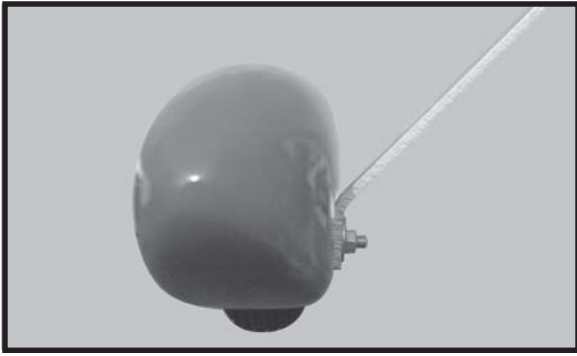

**INSTALLING THE MAIN LANDING GEAR**

- 1) The blind nuts are already mounted inside the fuselage.
- 2) The holes in the landing gear should be to accept the mounting bolts.

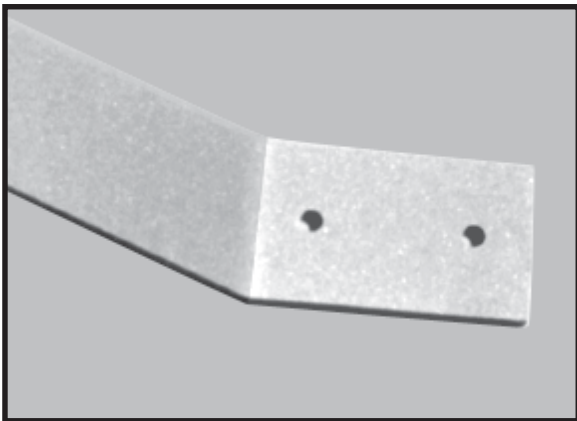

- 3) Using the hardware provided, mount the main landing gear to the fuselage.



**COWLING**

- 1) Slide the fiberglass cowl over the engine and line up the back edge of the cowl with the marks you made on the fuselage.

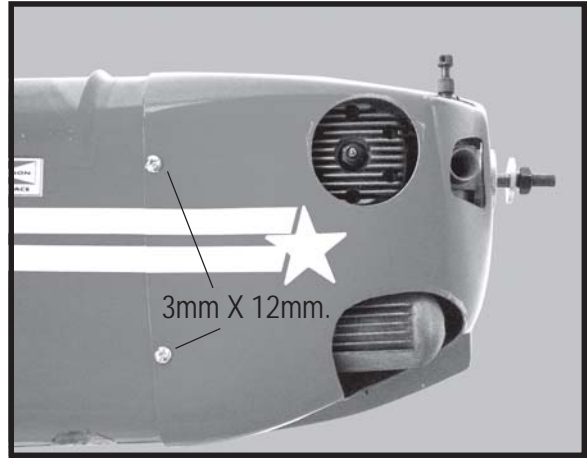

- 2) While keeping the back edge of the cowl flush with the marks, align the front of the cowl with the crankshaft of the engine. The front of the cowl should be positioned so the crankshaft is in **nearly** the middle of the cowl opening. Hold the cowl firmly in place using pieces of masking tape.



⚠ Because of the diameter of the cowl, it may be necessary to use a needle valve extension for the high speed needle valve. Make this out of sufficient length 1.5mm wire and install it into the end of the needle valve. Secure the wire in place by tightening the set screw in the side of the needle valve.

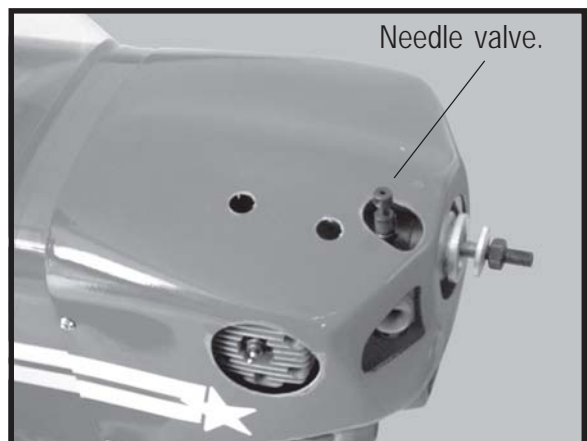



- 3) Slide the cowl back over the engine and secure it in place using four wood screws. See picture below.
- 4) Install the muffler and muffler extension onto the engine and make the cutout in the cowl for muffler clearance. Connect the fuel and pressure lines to the carburetor, muffler and fuel filler valve.



- 5) It is recommended to install a Muffler extension. ( this item is not include ).

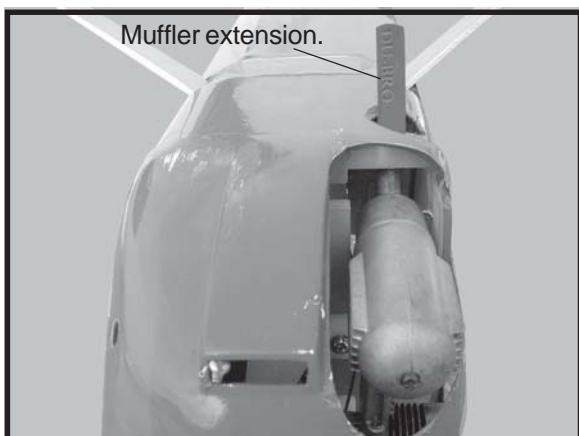

**INSTALLING THE SPINNER**

- 1) Install the spinner backplate, propeller and spinner cone. The spinner cone is held in place using two 3mm x 12mm wood screws.
  - ⚠ The propeller should not touch any part of the spinner cone. If it does, use a sharp modeling knife and carefully trim away the spinner cone where the propeller comes in contact with it.



**ALIGNING THE HORIZONTAL STABILIZER**

- 1) Using a ruler and a pen, locate the centerline of the horizontal stabilizer, at the trailing edge, and place a mark. Use a triangle and extend this mark, from back to front, across the top of the stabilizer. Also extend this mark down the back of the trailing edge of the stabilizer.

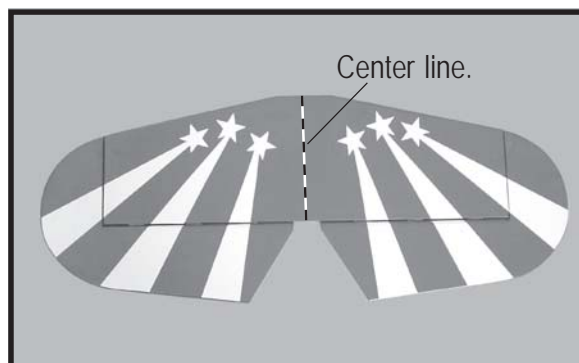

- 2) Slide the stabilizer into place in the pre-cut slot in the rear of the fuselage. The stabilizer should be pushed firmly against the front of the slot.

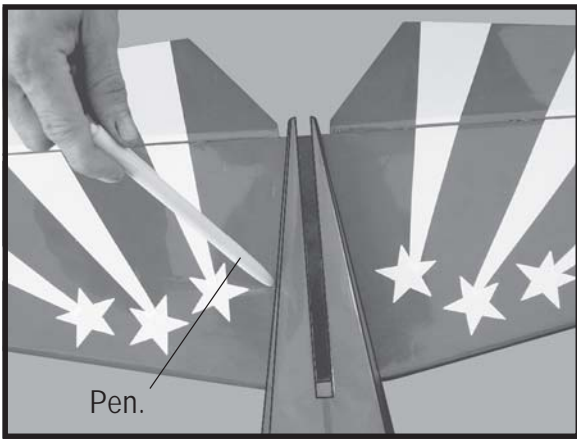

- 3) With the stabilizer held firmly in place, use a pen and draw lines onto the stabilizer where it and the fuselage sides meet. Do this on both the right and left sides and top and bottom of the stabilizer.
- 4) Remove the stabilizer. Using the lines you just drew as a guide, carefully remove the covering from between them using a modeling knife.

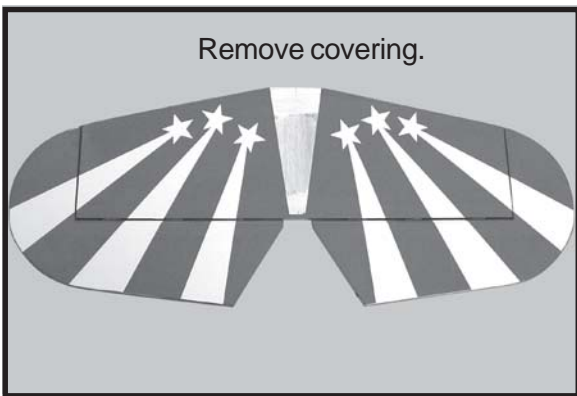

 When cutting through the covering to remove it, cut with only enough pressure to only cut through the covering itself. Cutting into the balsa structure may weaken it.

- 5) Using a modeling knife, carefully remove the covering that overlaps the stabilizer mounting platform sides in the fuselage. Remove the covering from both the top and the bottom of the platform sides.
- 6) When you are sure that everything is aligned correctly, mix up a generous amount of Flash 30 Minute Epoxy. Apply a thin layer to the top and bottom of the stabilizer mounting area and to the stabilizer mounting platform sides in the fuselage. Slide the stabilizer in place and realign. Double check all of your measurements once more before the epoxy cures. Hold the stabilizer in place with T-pins or masking tape and remove any excess epoxy using a paper towel and rubbing alcohol.



- 7) After the epoxy has fully cured, remove the masking tape or T-pins used to hold the stabilizer in place. Carefully inspect the glue joints. Use more epoxy to fill in any gaps that may exist that were not filled previously and clean up the excess using a paper towel and rubbing alcohol.

### VERTICAL STABILIZER INSTALLATION



- 1) Using a modeling knife, remove the covering from over the precut hinge slot cut into the lower rear portion of the fuselage. This slot accepts the lower rudder hinge.

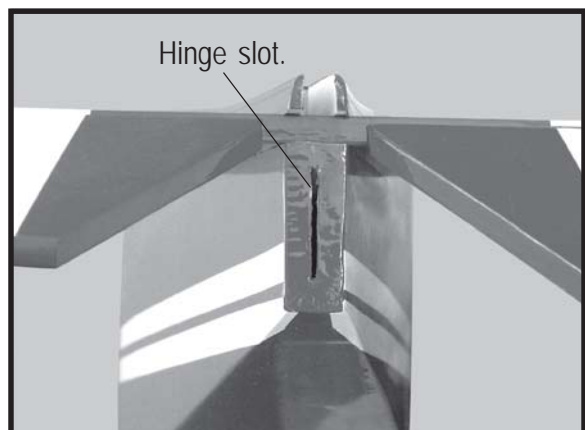

□ 2) Slide the vertical stabilizer into the slot in the top of the fuselage. The rear edge of the stabilizer should be flush with the rear edge of the fuselage and the lower rudder hinge should engage the precut hinge slot in the lower fuselage. The bottom edge of the stabilizer should also be firmly pushed against the top of the horizontal stabilizer.

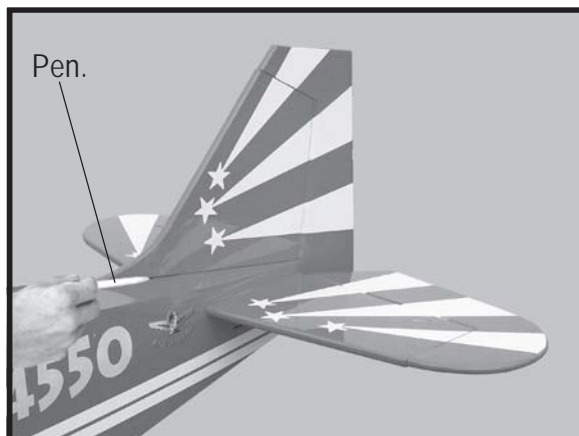

□ 3) While holding the vertical stabilizer firmly in place, use a pen and draw a line on each side of the vertical stabilizer where it meets the top of the fuselage.

□ 4) Remove the stabilizer. Using a modeling knife, remove the covering from below the lines you drew. Also remove the covering from the bottom edge of the stabilizer and the bottom and top edges of the filler block. Leave the covering in place on the sides of the filler block.

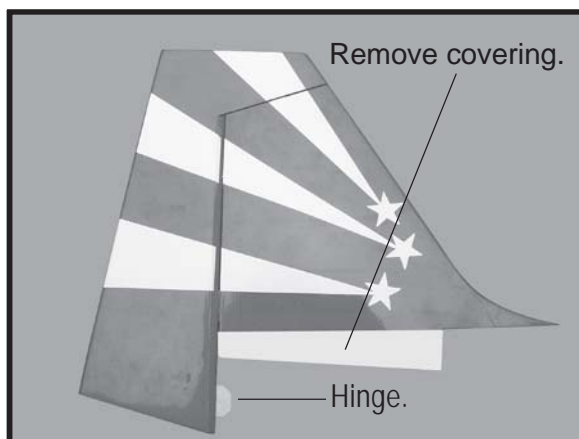

⚠ When cutting through the covering to remove it, cut with only enough pressure to only cut through the covering itself. Cutting into the balsa structure may weaken it.

□ 5) Slide the vertical stabilizer back in place. Using a triangle, check to ensure that the vertical stabilizer is aligned  $90^\circ$  to the horizontal stabilizer.

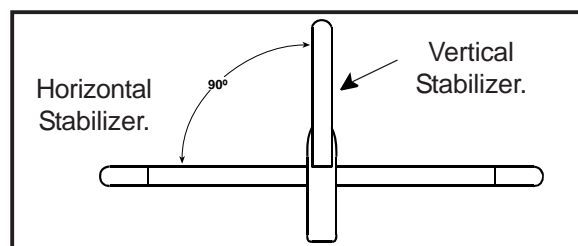

□ 6) When you are sure that everything is aligned correctly, mix up a generous amount of Flash 30 Minute Epoxy. Apply a thin layer to the mounting slot in the top of the fuselage and to the sides and bottom of the vertical stabilizer mounting area. Apply epoxy to the bottom and top edges of the filler block and to the lower hinge also. Set the stabilizer in place and realign. Double check all of your measurements once more before the epoxy cures. Hold the stabilizer in place with T-pins or masking tape and remove any excess epoxy using a paper towel and rubbing alcohol. Allow the epoxy to fully cure before proceeding.

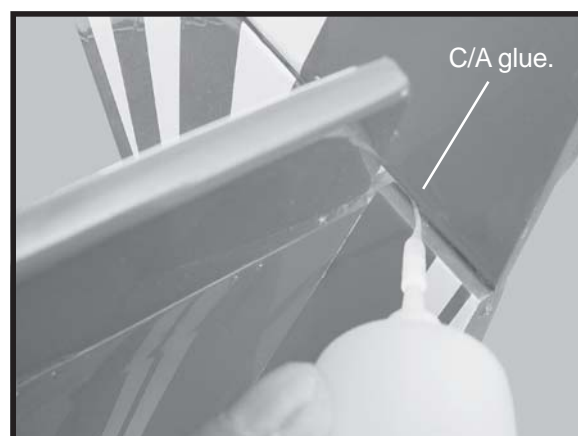
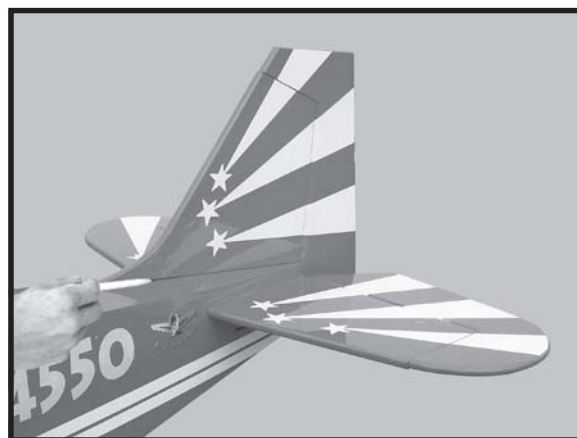

**CONTROL HORN INSTALLTION**

- 1) Locate the two nylon control horns, two nylon control horn backplates and four machine screws.
- 2) Position the elevator horn on the both side of elevator. The clevis attachment holes should be positioned over the hinge line.

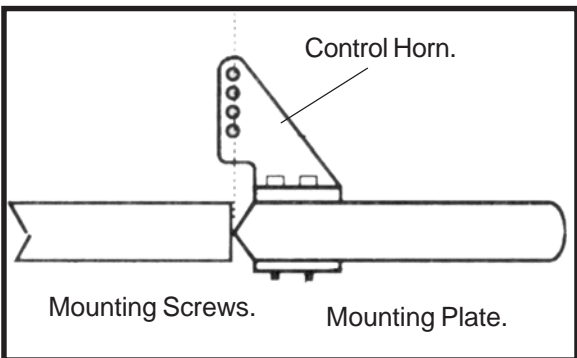
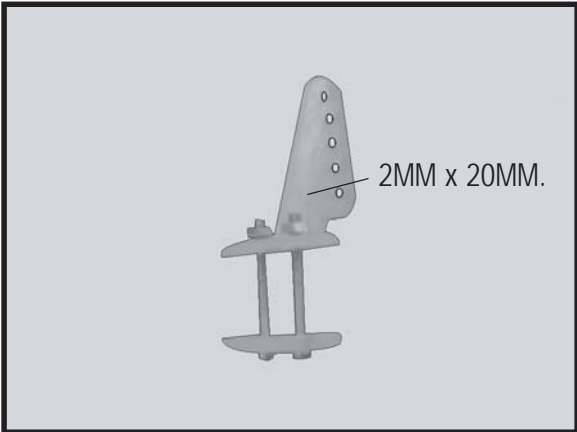

- 3) Using a 1.5mm drill bit and the control horns as a guide, drill the mounting holes through the elevator halves.
- 4) Mount the control horns by inserting the bolts through the control horn bases and elevator halves, then into the mounting backplates. Do Not overtighten the nuts may crush the wood.
- 5) Position the rudder control horn on the left side of the airplane. Mount the control horn parallel with the horizontal stabilizer, not in-line with the rudder hinge line.
- 6) Install the rudder control horn using the same method as with the elevator control horns.

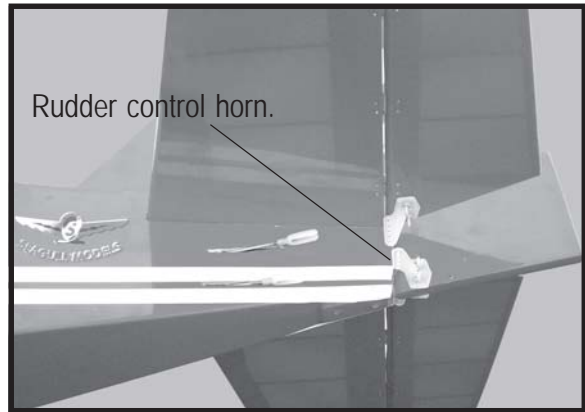
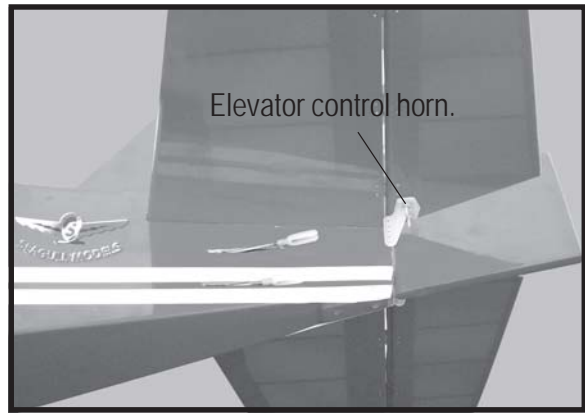

**ELEVATOR - RUDDER PUSHROD INSTALLATION**

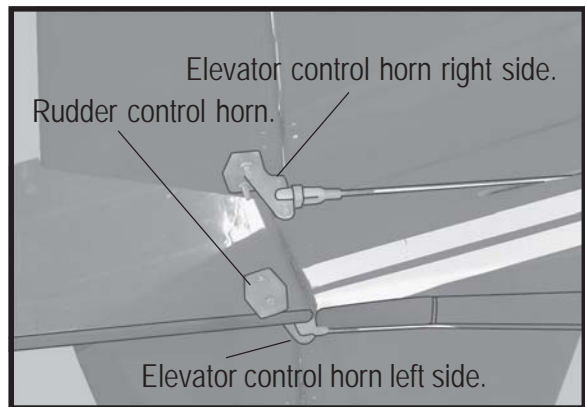
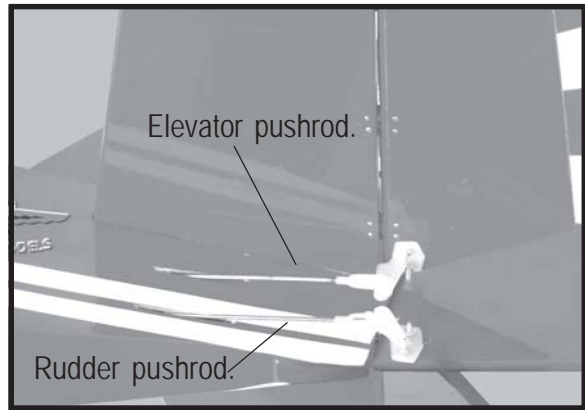

### MOUNTING THE CONTROL CLASP

- 1. Align the tail wheel wire so that the wire is parallel with the bottom of the rudder. The control clasp has a predrilled hole through the top of it. Slide this hole onto the tail wheel wire while sliding the clasp over the bottom of the rudder.
- 2. Using a ruler and a pen place a mark onto the bottom of the rudder. The back edge of the clasp should line up with this mark. You may find it necessary to bend the tail wheel wire down slightly so it lines up with the clasp without binding.
- 3. While holding the clasp firmly in place, use a pen and outline the clasp onto the rudder.
- 4. Remove the clasp, and using a modeling knife, remove the covering from inside the lines you drew. Use 220 grit sandpaper and carefully roughen the inside surface of the nylon clasp.
- 5. Slide the clasp back into position and carefully glue it into place using Kwik Bond Thin C/A. Hold the clasp in place until the glue completely cures. Secure by 1 machine screw.

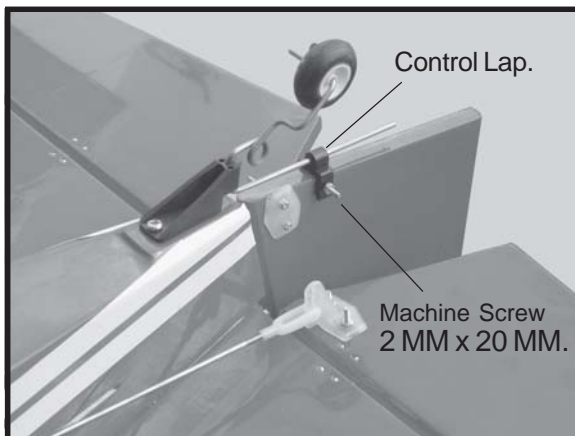

### INSTALLING THE FUSELAGE SERVOS

#### PARTS REQUIRED

- {3} Standard size servos
- {1} Receiver switch harness

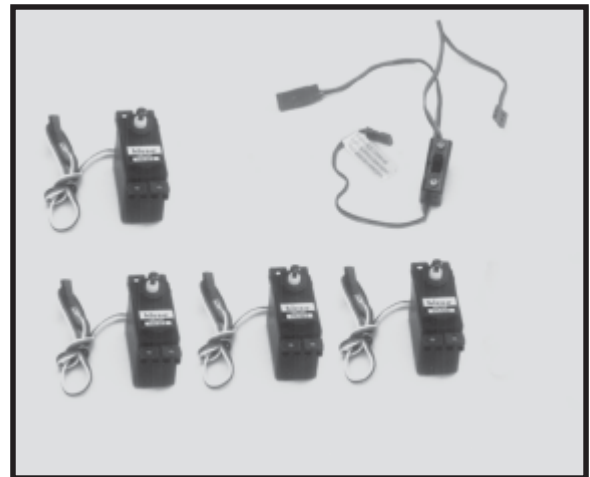

### INSTALLING THE SWITCH

- 1) Install the switch into the precut hole in the servo tray, in the fuselage, from the bottom. Use the two screws provided with the switch to secure it in place. Drill two 3/32" holes through the tray for the screws to pass through.
- 2) Using a 3/32" drill bit, drill a hole through the side of the fuselage, opposite the muffler, even with the switch.
- 3) Make a push-pull lever out of scrap wire. Attach the wire to the switch lever and route the wire out the side of the fuselage, through the hole you drilled.

⚠ Some switches come with a hole drilled through the switch tab for this very purpose. If your switch does not, remove the switch and drill a 3/32" hole through the middle of the switch tab.

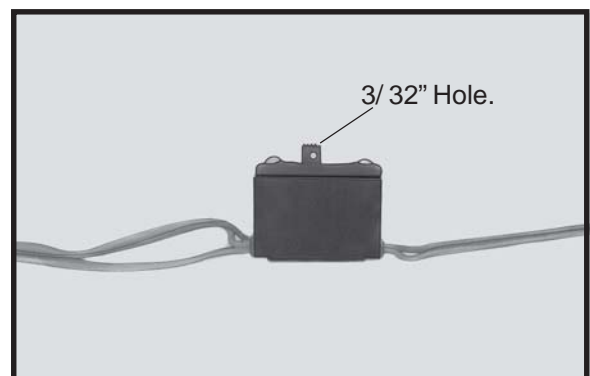

- 4) Install the rubber grommets and brass collets onto the elevator, rudder and throttle servos. Test fit the servos into the preinstalled servo tray. Because the size of servos differ, you may need to adjust the size of the precut openings in the tray.
- 5) Position the servos into the servo tray with the output shafts orientated as shown below. Drill 1/16" pilot holes through the tray for each of the mounting screws.

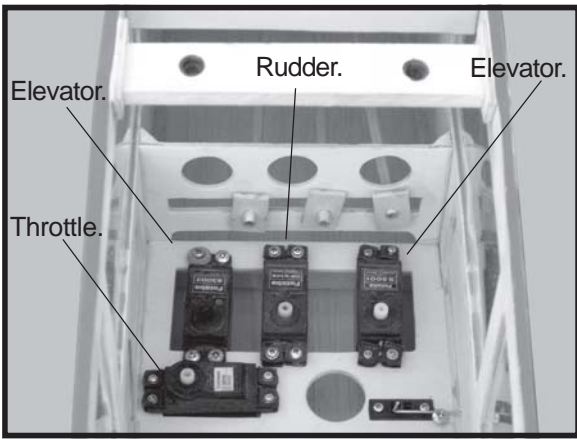

- 6) Install adjustable servo connector in the servo arm.

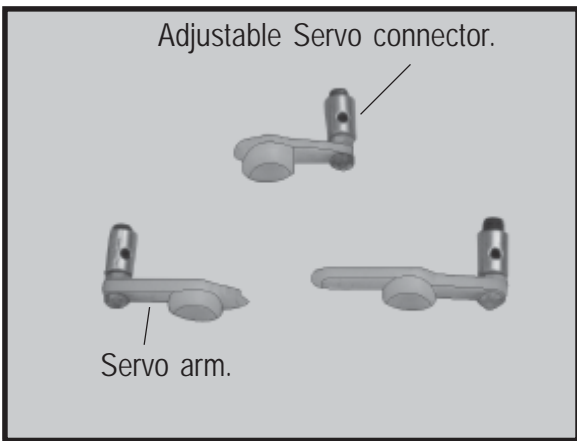

- 7) Connect the elevator, rudder and throttle servos to your radio's receiver and turn on the system. Set the trim tabs on the transmitter to neutral and center the servo arms. The elevator, rudder and throttle servo arms should be perpendicular to the servos.
- 8) One at a time, hold the pushrods in position over the respective servos to check for proper servo direction. If any servo turns in the wrong direction, switch your radio's reversing switches as necessary to achieve the correct direction.
- 9) Install servos arm to servos. Notice the position of the servo arms on the servos. See picture as below.

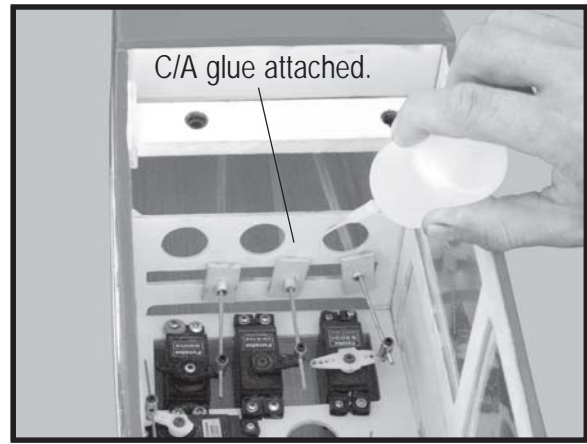

**INSTALLING THE RECEIVER AND BATTERY**

- 1) Plug the five servo leads and the switch lead into the receiver. Plug the battery pack lead into the switch also.
- 2) Wrap the receiver and battery pack in the protective foam rubber to protect them from vibration.
- 3) Position the battery pack in the fuel tank compartment and the receiver just behind the fuel tank . Use extra foam pieces to hold them in position.

 When balancing the airplane you may need to move the battery or receiver forward or after to achieve proper balance.

- 4) Using a 1/16" drill bit, drill a hole through the side of the fuselage, near the receiver, for the antenna to exit. Route the antenna out of the fuselage and secure it to the vertical stabilizer using a rubber band and a modified servo arm. See picture as below.

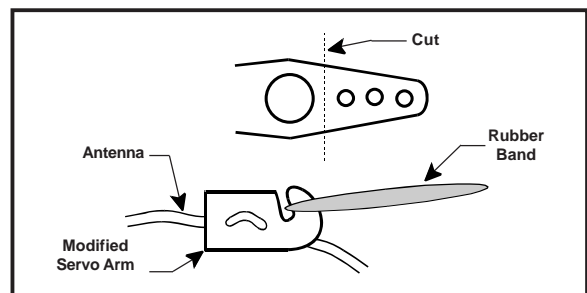

**FUSELAGE & WING INSTALLATION**

Bolt the wing to fuselage.

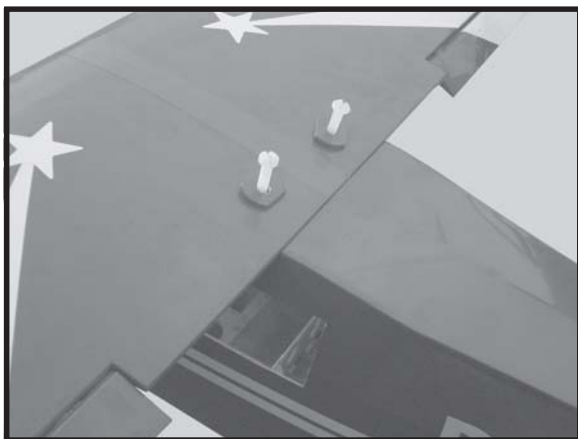
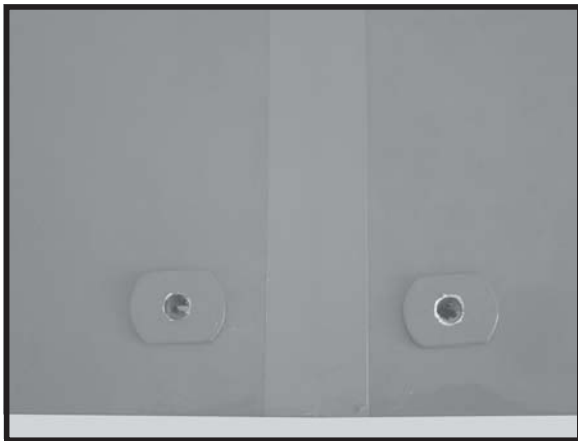
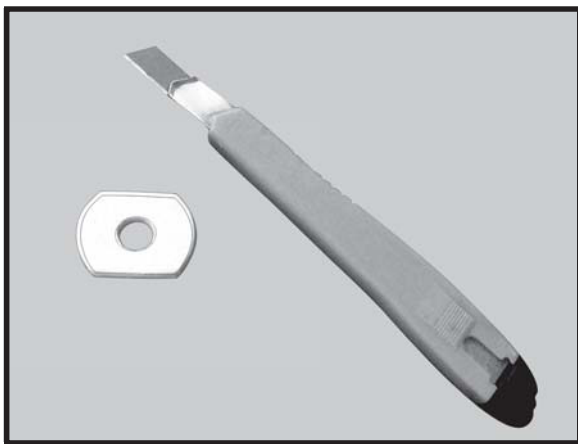
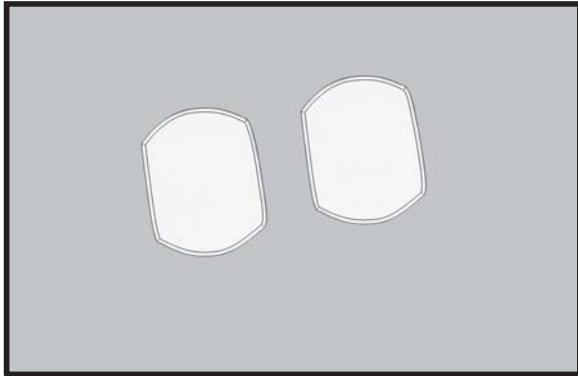

**WING STRUT INSTALLATION**

Parts requirement. See picture below:

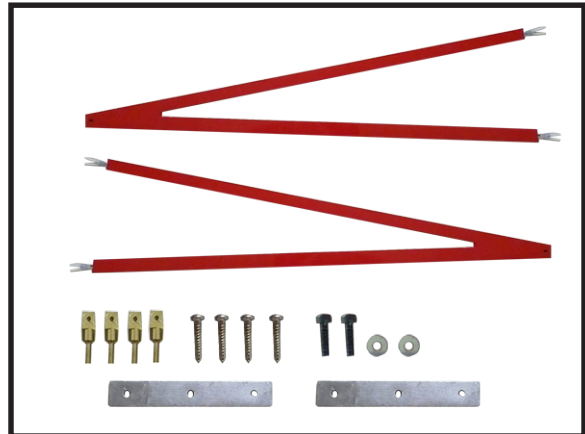

Installing aluminum plate follow picture below:

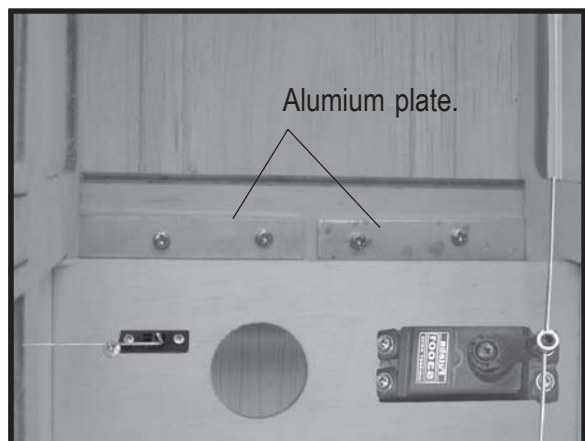

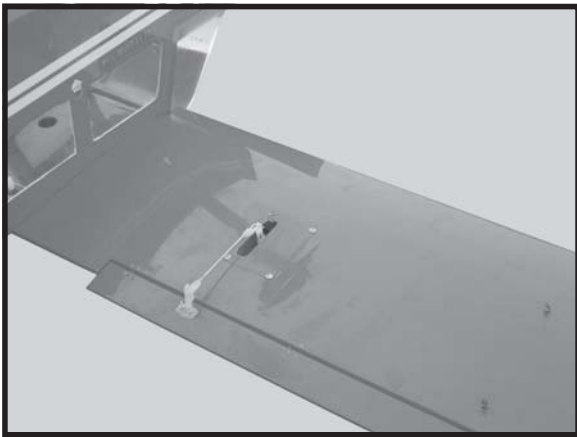
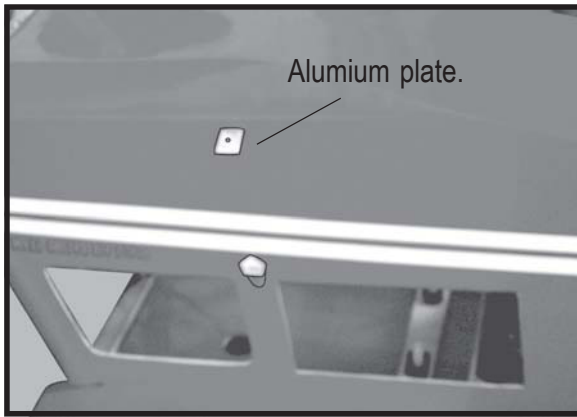

## BALANCING

□ 1) It is critical that your airplane be balanced correctly. Improper balance will cause your plane to lose control and crash. The center of gravity is located 8 - 9cm back from the leading edge of the wing, measured at the wing tip.

□ 2) If the nose of the plane falls, the plane is nose heavy. To correct this first move the battery pack further back in the fuselage. If this is not possible or does not correct it, stick small amounts of lead weight on the fuselage sides under the horizontal stabilizer. If the tail of the plane falls, the plane is tail heavy. To correct this, move the battery and receiver forward or if this is not possible, stick weight onto the firewall or use a brass heavy hub spinner hub. When balanced correctly, the airplane should sit level or slightly nose down when you lift it up with your fingers.

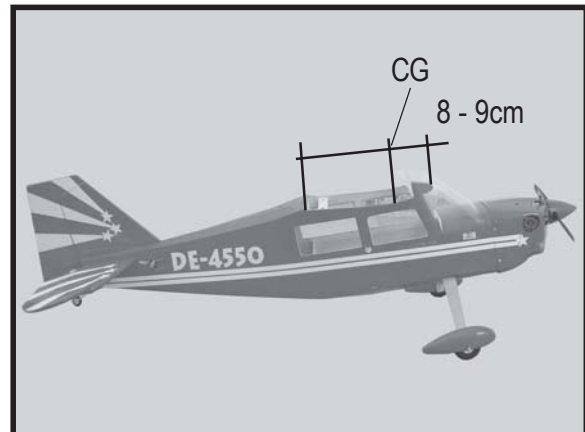



## CONTROL THROWS

- 1) We highly recommend setting up the **DECATHLON** using the control throws listed at right. We have listed control throws for both initial test/sport flying and aerobatic flying.
- 2) Turn on the radio system, and with the trim tabs on the transmitter in neutral, center the control surfaces by making adjustments to the clevises or adjustable servo connectors. The servo arms should be centered also.
- 3) When the elevator, rudder and aileron control surfaces are centered, use a ruler and check the amount of the control throw in each surface. **The control throws should be measured at the widest point of each surface!**

### INITIAL FLYING/SPORT FLYING

Ailerons low rate - 3/8" up - 3/8" down  
 Ailerons high rate - 7/8" up - 7/8" down

Elevators low rate - 3/16" up - 3/16" down  
 Elevators high rate - 3/8" up - 3/8" down

Rudder low rate - 3/4" left and right  
 Rudder high rate - 1 1/4" left and right

Do not use the aerobatic settings for initial test flying or sport flying.

- 4) By moving the position of the adjustable control horn out from the control surface, you will decrease the amount of throw of that control surface. Moving the adjustable control horn toward the control surface will increase the amount of throw.

## FLIGHT PREPARATION

- A) Check the operation and direction of the elevator, rudder, ailerons and throttle.
- B) Plug in your radio system per the manufacturer's instructions and turn everything on.
- C) Check the elevator first. Pull back on the elevator stick. The elevator halves should move up. If it they do not, flip the servo reversing switch on your transmitter to change the direction.
- D) Check the rudder. Looking from behind the airplane, move the rudder stick to the right. The rudder should move to the right. If it does not, flip the servo reversing switch on your transmitter to change the direction.
- E) Check the throttle. Moving the throttle stick forward should open the carburetor barrel. If it does not, flip the servo reversing switch on your transmitter to change the direction.
- F) From behind the airplane, look at the aileron on the right wing half. Move the aileron stick to the right. The right aileron should move up and the other aileron should move down. If it does not, flip the servo reversing switch on your transmitter to change the direction.

## FLIGHT PREPARATION

1) Check the operation and direction of the elevator, rudder, ailerons and throttle.

A) Plug in your radio system per the manufacturer's instructions and turn everything on.

B) Check the elevator first. Pull back on the elevator stick. The elevator halves should move up. If it they do not, flip the servo reversing switch on your transmitter to change the direction.

C) Check the rudder. Looking from behind the airplane, move the rudder stick to the right. The rudder should move to the right. If it does not, flip the servo reversing switch on your transmitter to change the direction.

D) Check the throttle. Moving the throttle stick forward should open the carburetor barrel. If it does not, flip the servo reversing switch on your transmitter to change the direction.

E) From behind the airplane, look at the aileron on the right wing half. Move the aileron stick to the right. The right aileron should move up and the other aileron should move down. If it does not, flip the servo reversing switch on your transmitter to change the direction.

2) Check Control Surface Throw.

A) The Rudder should move 3/4" left and 3/4" right from center. If it moves too far, turn the adjustable control horn out away from the rudder. Do the opposite if there is not enough throw.

B) Both elevator halves should move 5/16" up and 5/16" down from center. If they move too far, turn the adjustable control horns out away from the elevator halves. Do the opposite if there is not enough throw. Both elevator halves should also travel the same amount throughout their total movement.

C) The ailerons should move 3/16" up and 3/16" down from center. If the ailerons

move too much, turn the adjustable control horns out away from the wing. Do the opposite if there is not enough throw. It is important that both ailerons move the same amount, both up and down.

D) Once the control throws and movements are set, tubing must be added to the clevises to ensure they do not release in the air. Cut a piece of fuel line into five 1/4" long pieces. Unsnap the clevises and slip one piece over each clevis. Snap the clevises back in place and slide the tubing up over them.

## PREFLIGHT CHECK

1) Completely charge your transmitter and receiver batteries before your first day of flying.

2) Check every bolt and every glue joint in the **DECATHLON** to ensure that everything is tight and well bonded.

3) Double check the balance of the airplane. Do this with the fuel tank empty.

4) Check the control surfaces. All should move in the correct direction and not bind in any way.

5) If your radio transmitter is equipped with dual rate switches double check that they are on the low rate setting for your first few flights.

6) Check to ensure the control surfaces are moving the proper amount for both low and high rate settings.

7) Check the receiver antenna. It should be fully extended and not coiled up inside the fuselage.

8) Properly balance the propeller. An out of balance propeller will cause excessive vibration which could lead to engine and/or airframe failure.

***We wish you many safe and enjoyable flights with your DECATHLON.***