



2300mm FOX

Operating Manual



Specifications

Wingspan.....	2300mm/90.5in
Flying Length.....	1290mm/50.7in
Weight.....	1150g(40.6oz)
Wing Area.....	36.5dm ² (565.8 in ²)
Wing Load.....	31.5g/dm ² (0.07oz/in ²)
Radio Controls.....	4 Channel



<http://www.facebook.com/FMSmodel>



www.fmsmodel.com

Please visit both our Facebook fanpage and our homepage for updated product information

WARNING!

 **WARNING:** Read the ENTIRE instruction manual to become familiar with the features of the product before operating. Failure to operate the product correctly can result in damage to the product, personal property and cause serious injury.

This is a sophisticated hobby product and NOT a toy. It must be operated with caution and common sense and requires some basic mechanical ability. Failure to operate this Product in a safe and responsible manner could result in injury or damage to the product or other property. This product is not intended for use by children without direct adult supervision.

This manual contains instructions for safety, operation and maintenance. It is essential to read and follow all the instructions and warnings in this manual prior to assembly, setup, or use, in order to operate correctly and avoid damage or serious injury.

Safety Precautions and Warnings

As the user of this product, you are solely responsible for operating in a manner that does not endanger yourself and others or result in damage to the product or the property of others. This model is controlled by a radio signal subject to interference from many sources outside your control. This interference can cause momentary loss of control so it is advisable to always keep a safe distance in all directions around your model, as this margin will help avoid collisions or injury.

Age Recommendation: Not for children under 14years. This is not a toy.

- Never operate your model with low transmitter batteries.
- Always operate your model in an open area away from cars, traffic or people.
- Avoid operating your model in the street where injury or damage can occur.
- Never operate the model in the street or in populated areas for any reason.
- Carefully follow the directions and warnings for this and any optional support equipment (chargers, rechargeable battery packs, etc.) you use.
- Keep all chemicals, small parts and anything electrical out of the reach of children.
- Moisture causes damage to electronics. Avoid water exposure to all equipment not specifically designed and protected for this purpose.
- Never lick or place any portion of your model in your mouth as it could cause serious injury or even death.

FMS MODEL Friendly Reminder



Thank you for purchasing a FMS MODEL product. Our goal is to provide high quality products and offer great customer service. If you have any problems with your product or want to offer suggestions for improvements (such as plane design, packaging, building instructions, etc.) please feel free to contact us at info@fmsmodel.com

Table of contents

Kit contents	1
The spare parts list	1
Spare parts list content	
The illustration of the spare parts	
Kit Inspection	3
Charging the Flight Battery	3
Using Steps	
Charging Function Description	
Self Checking Function	
Protection Function	
Troubleshooting	
Low Voltage Cut off (LVC)	
Assemble the plane	5
Install the main wing	
Install the battery	
Install the elevator	
Disassembly	
Get your model ready to fly	11
Important ESC and plane information	
The transmitter and model setup	
Check the C.G. (Center of Gravity)	
Before the model flying	15
Find a suitable flying site	
Perform the range check of your plane	
Monitor your flight time	
Flying course	16
Take off	
Flying	
Landing	
Maintenance	
Troubleshooting	17
ESC instruction	18

Kit contents

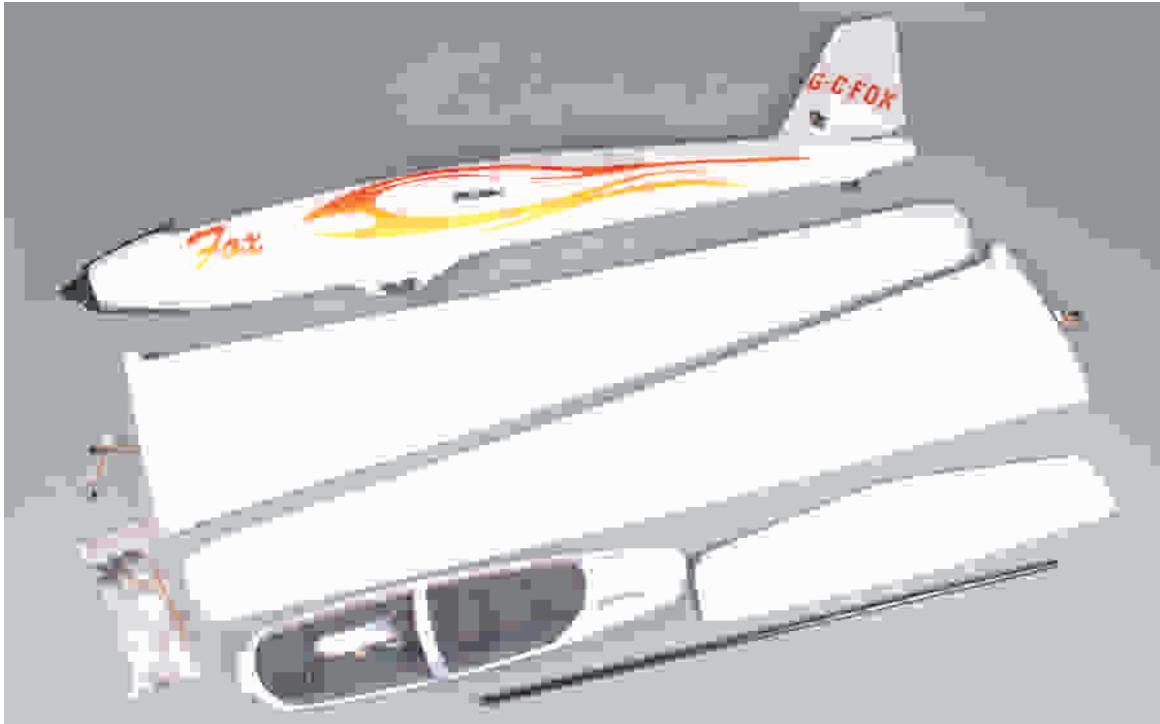

Kit contents

1. The fuselage assembly (With the motor, the canopy, the electronic parts, ESC)
2. Horizontal stabilizer
3. Propeller and spinner
4. Spare parts bag
5. Main wing tube
6. Main wing

The spare parts list

Replacement parts for the **FOX** are available using the order numbers in the Spare parts list that follows. The fastest, most economical service can be provided by your hobby dealer or mail-order company.

Spare parts list content

Spare parts list content

- MT 101 Fuselage (With all the plastic parts and rudder installed)
- MT 102 Main wing set (With the control horn in stored)
- MT 103 Horizontal stabilizer (With the elevator connector installed)
- MT 104 Spinner
- MT 301 Propeller
- MT 302 Canopy (one plastic canopy)
- MT 303 Canopy (one foam canopy)
- MT 304 Sticker
- MT 305 Pipe
- MT 306 Motor Board (V2)
- MT 307 Linkage Rods
- FMS-Motor 4018 KV900
- FMS-ESC-30A (150mm input cable)
- FMS-Battery-11.1V 1300mAh 35C
- FMSSER9GP

Note: All of the parts are painted with no decal applied.

The illustration of the spare parts

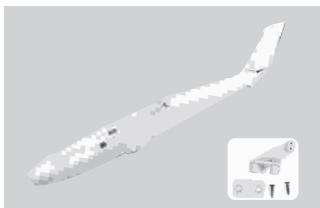

MT101

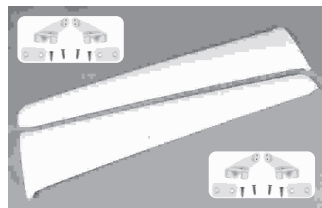

MT102 (V2)

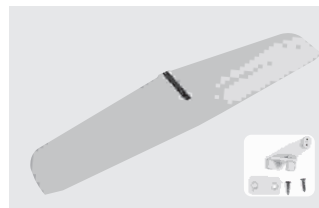

MT103



MT104



MT301



MT302

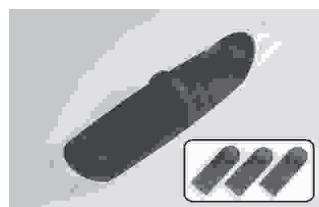

MT303



MT304

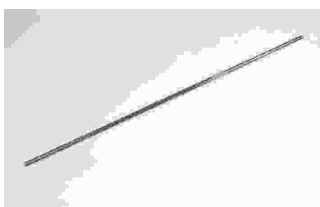

MT305



MT306(V2)

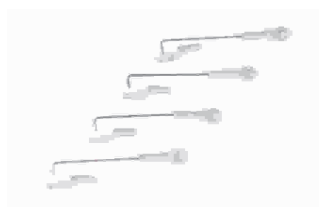

MT307



FMS-Motor
4018 KV900

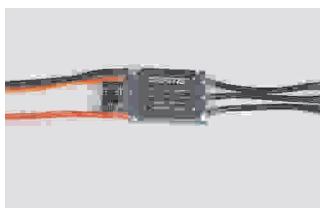

FMS-ESC-30A
(150mm input cable)



FMS-Battery-11.1V
1300mah 35C



FMSSER9GP

Kit inspection

Before starting to build, inspect the parts to make sure they are acceptable quality. If any parts are missing or are not in good shape or acceptable quality, or if you need assistance with setup and assembly, please feel free to contact FMSteam. Please write down the name of the parts when you are reporting defective or missing of them.

FMSteam Product Support

ADDRESS: **3/F, Building B, 3rd Industry Zone, Matigang, Dalingshan Town, Dongguan City, P.R.C**

Ph: **0086-769-86976655**

Charging the Flight Battery

The Battery Charger is designed to safely charge the Li-Po battery,

Caution: All instructions and warnings must be followed exactly. Mishandling of Li-Po batteries can result in fire, personal injury, or property damage.

Battery warning:

By handling, charging or using the included Li-Po battery you assume all risks associated with lithium batteries.

If at any time the batteries begin to swell, or balloon, discontinue use immediately! Charging or discharging a swelling or ballooning battery can result in fire.

Always store the batteries at room temperature in a dry area to extend the life of the battery. Always transport or temporarily store the battery in a temperature range of 40-120°F. Do not store battery or model in a car or in direct sunlight. If stored in a hot car, the battery can be damaged or even catch fire.

Never use a Ni-Mh charger. Failure to charge the battery with a compatible charger may cause fire resulting in personal injury and property damage.

Never discharge Li-Po cells to below 3V.

Never leave charging batteries unattended.

Never charge damaged batteries.

Charging the flight battery

When charging the battery, make certain the battery is on a heat-resistant surface, charge the battery before assembly of the airplane. Install the fully charged battery to perform control tests and binding.

Charging the Flight Battery

Electrical Parameters

Parameter	Min	Type	Max	Unit
Working Voltage	9	12	16	V
Input Power	15			W
Work Temperature	- 20		45	°C
Store Temperature	- 20		65	°C
Charging Stop Voltage	4 . 19	4 . 20	4 . 21	V
Charging Current			1000	mA
Balancing Current	150		200	mA
Activate Current	80		120	mA

Using Steps:

1. Connect the charger to adapter with enough voltage and wattage, then the Power LED will turn on;
2. Connect 2S/3S battery pack to the corresponding balance port (**Do not connect two battery packs at the same time**), then the Charge LED will flicker (1Hz) and start charging.
3. When the Charge LED stops flickering, charging is complete, and the batteries can be unplugged.

Charging Function Description

1. If all voltage of the installed battery pack is higher than 4.18V, charging will not start and the charge LED will shine.
2. If the voltage of one battery or some batteries is lower than 0.7V, charging will not start. If the voltage of the first battery of a 3S battery pack is lower than 0.7V, the charger will charge the battery pack as if it was a 2S battery pack.
3. If the voltage of one battery or some batteries is lower than 2.8V, the charger will activate the battery pack with a small current. If the voltage can't be increased above 2.8V after half an hour, the charger will judge the battery pack as bad. The charge LED will then flicker rapidly (0.5Hz), and charging will stop.

Self Checking Function

1. Charger will perform a self test before each charge. The charge LED will rapidly flicker (0.5Hz) if the charging function is abnormal;
2. Accuracy checking Function: Connect a fully charged 3S battery pack (all voltage at least 4.2V), the charge LED will flicker twice then shine always. This means that the accuracy is normal.

Charging the Flight Battery

Protection Function

1. Reverse connection protection of input
2. Reverse connection protection of output
3. Short circuit protection of output
4. Over voltage protection of output

Troubleshooting

1. **Power LED does not shine** – Adapter isn't connected correctly. Please check the polarity and reconnect adapter.
2. **Charging abruptly stops and tries to restart constantly during charging** – Output power of the adapter is not sufficient, please replace the adapter.
3. **Charge LED does not shine** – Reconnect the battery pack; Check the voltage of batteries.
4. **Charge LED rapidly flickers** – Battery is bad or charging function is abnormal. Replace battery or contact technical support.

Low voltage cut off (LVC)

When a Li-Po is discharged below 3V per cell, it will not hold a charge. The ESC protects the flight battery from over-discharge using Low Voltage Cutoff. Before the battery charge decreases too much, LVC removes power from motor in two ways: (1) Reduces power - ESC reduces motor power (recommended), (2) Hard cutoff - ESC instantly cuts motor power when the pre-set Low Voltage Protection Threshold value is reached. These settings can be changed using the ESC programming guide (available on-line).

Assemble the plane

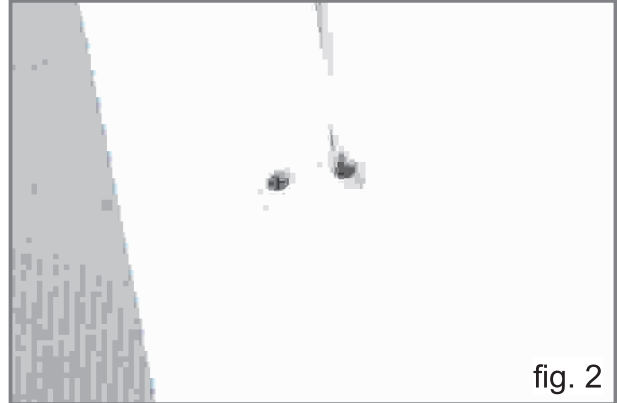
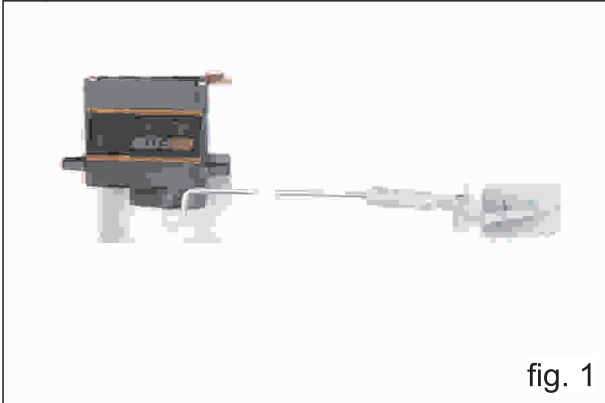

Connect the aileron control rod linkages

- 1) Slide the provided piece of fuel tubing over the control rod linkage and then insert the control rod linkage thru the desired hole in the aileron servo arm (fig. 3). Note: For a single rate transmitter use the first hole to achieve a high rate setting. Use the third hole nearest the servo to achieve a low rate setting.
- 2) Press the hole in the clevis over the end of the control rod linkage, rotate it and snap the base of the clevis over the control rod linkage (fig. 4).

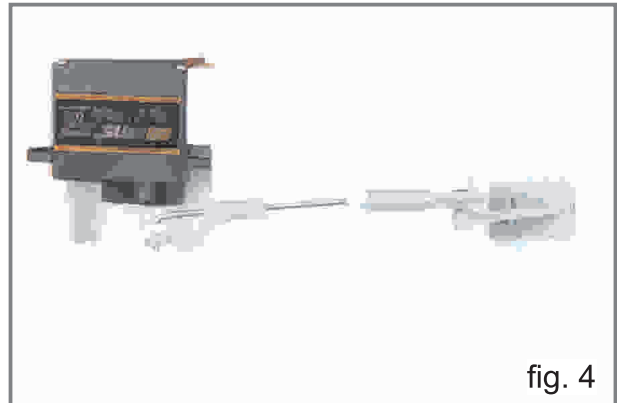
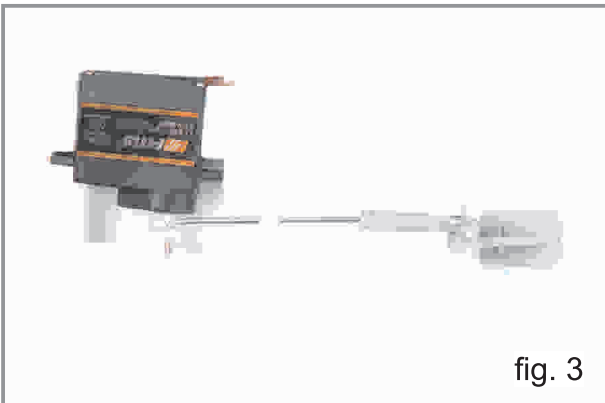

- 3) Slide the fuel tubing over the clevis to secure it (fig. 5). Note: Do not slide the fuel tubing too far or binding of the servo arm could result (fig. 6). Repeat steps 3-5 for the other aileron control rod linkage.

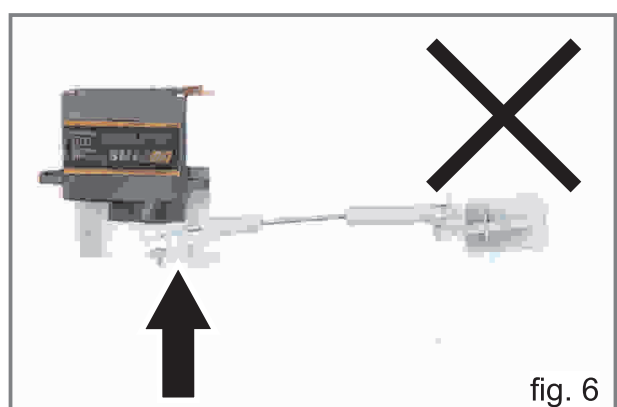
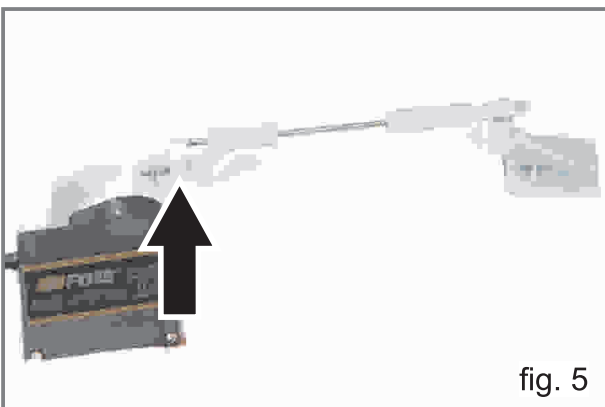

Install the main wing

1. Insert the pipe into the wing,
Connect the Y cable

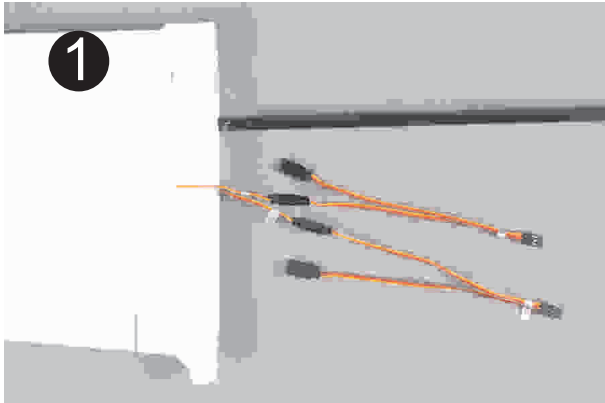

2. Assemble the wing. Connect the
opposite end of Y cable.

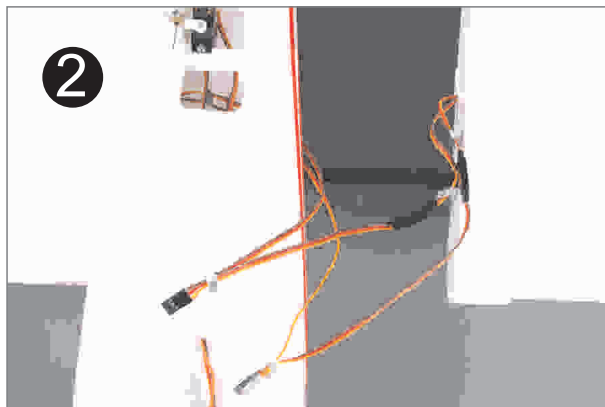

3. Assemble the full wing. Insert the
wings at the both sides of fuselage.
Insert the Y cable of aileron from
the bottom front

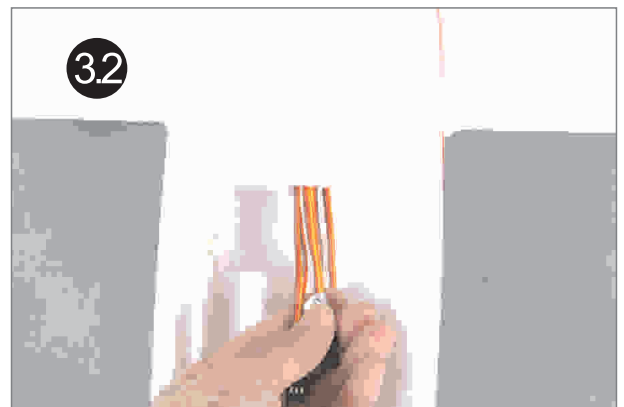
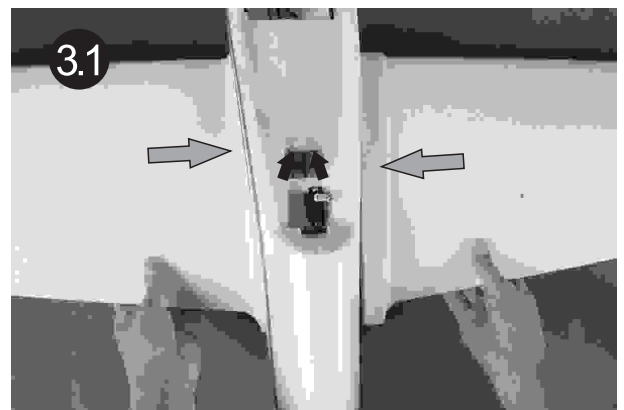

4. Fix the wing and pipe provided screws.
Do not over tighten the screws but
make sure it's tight enough.

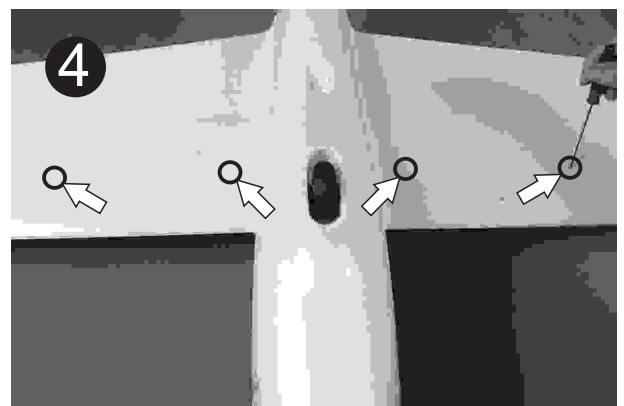

Assemble the plane

Install the battery

1. Slide the battery into the hook and loop ring from the back of the battery compartment with the cable toward the rear side of the hatch.

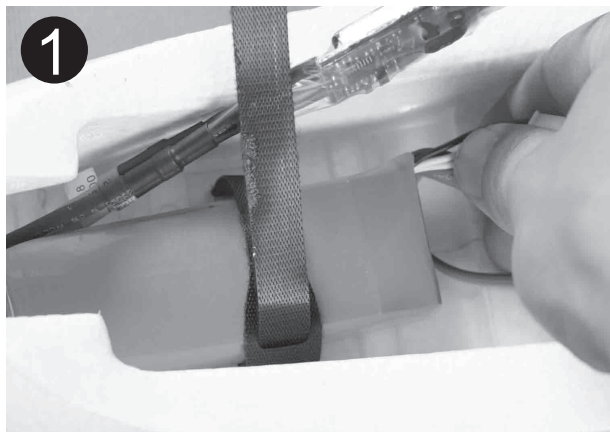

2. Secure the battery into place using the hook strip.

Note: Do not arm the ESC while placing the battery into the compartment.

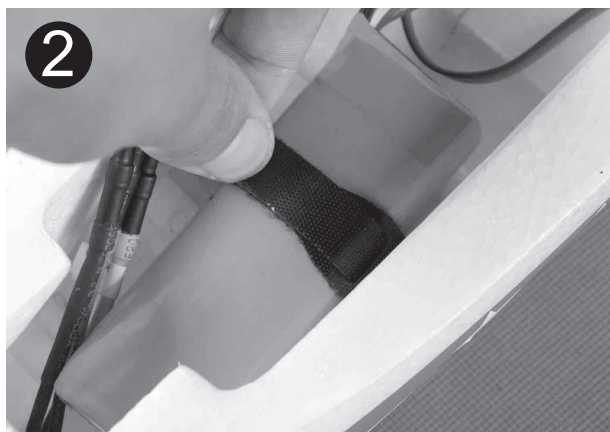

The receiver connection

Attach right v-tail to the elevator channel of your receiver. The left v-tail goes to the rudder channel of your receiver. You will need to activate the V-tail configuration of your transmitter. Attach the ESC connector to the throttle channel of the receiver.

Receiver

Aileron	1	Channel-1 — Aile
Elevator	2	Channel-2 — Elev
Throttle	3	Channel-3 — Thro
Rudder	4	Channel-4 — Rudd
Flaps	6	Channel-6 — Flaps

The placement of the receiver

1. Place the receiver in the fuselage cavity on the rear end of the canopy hatch.

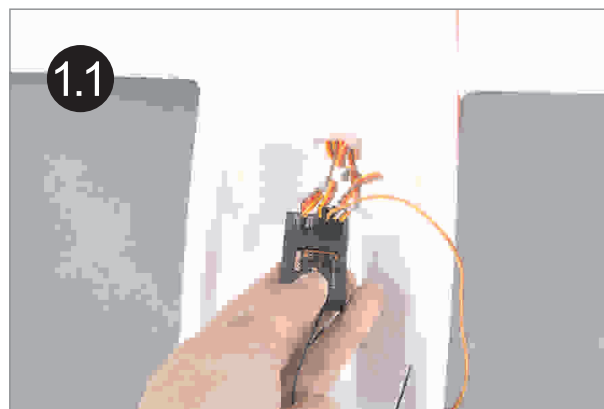

Install the elevator

1. Install the linkage rod of the elevator.

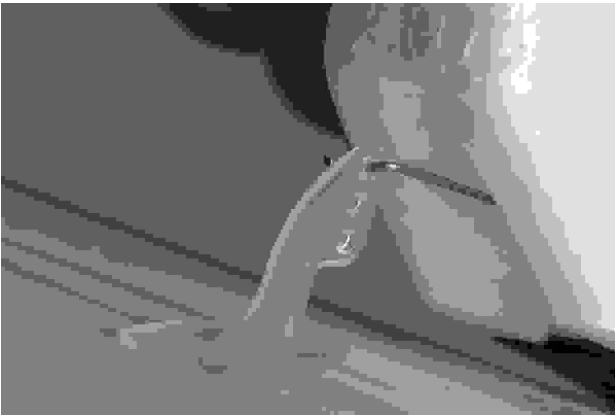

2. Insert the Horizontal stabilizer half into the tail mounting slot

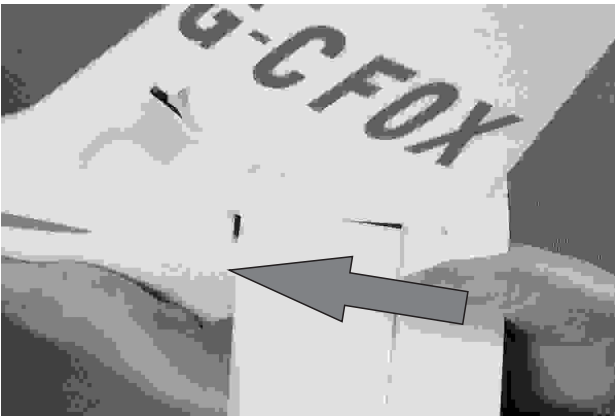

3. Secure the rudder using the provided screws **PM 3.0*35(2PCS)**.

Note: Do not over tighten the screws but make sure it is tight enough.

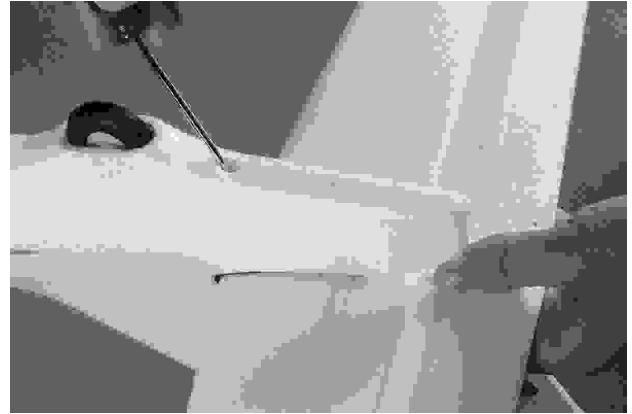

4. Loosen the screws on the control connectors which hold the control rods in place



Assemble the plane

Disassembly

1. The spinner is snapped into the propeller backplate. To remove, hold the spinner near the root of the propeller and squeeze gently.

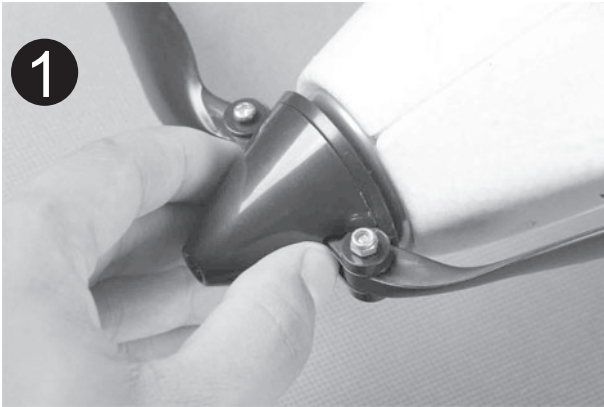

2. Remove the nut using a nose needle plier or a socket wrench while holding the propeller set into place.



3. Remove the propeller set from the motor shaft.



4. Always check that the foldaway propeller blades are attached properly. Make sure that the bolts are on completely, but not too tight or they will prevent the blades from spinning freely.



Get your model ready to fly

Important ESC and model information

1. The ESC included with the **FOX** has a safe start. If the motor battery is connected to the ESC and the throttle stick is not in the low throttle or off position, the motor will not start until the throttle stick is moved to the low throttle or off position. Once the throttle stick is moved to the low throttle or off position, the motor will emit a series of beeps. Several beeps with the same tune means the ESC has detected the cells of the battery. The count of the beeps equal the cells of the battery. The motor is now armed and will start when the throttle is moved.
2. The motor and ESC come pre-connected and the motor rotation should be correct. If for any reason the motor is rotating in the wrong direction, simply reverse two of the three motor wires to change the direction of rotation.
3. The motor has an optional brake setting. The ESC comes with the brake switched off and we recommended that the **FOX** be flown with the brake off. However, the brake could be accidentally switched on if the motor battery is connected to the ESC while the throttle stick is set at full throttle. To switch the brake off, move the throttle stick to full throttle and plug in the motor battery. The motor will beep one time. Move the throttle stick to low throttle or the off position. The motor is ready to run and the brake will be switched off.
4. Battery Selection and Installation. We recommend the 11.1V 1300mAh 35C Li-Po battery. If using another battery, the battery must be at least a 11.1V 1300mAh 35C battery. Your battery should be approximately the same capacity, dimension and weight as the 11.1V 1300mAh 35C Li-Po battery to fit in the fuselage without changing the center of gravity significantly.
5. The specification of the model list as follow:
 - Wing span: 2300mm/90.5in
 - Length: 1290mm/50.7in
 - Motor : 4018-KV900
 - ESC : 30A
 - Battery : 11.1V 1300mAh 35C
 - Servo : 9g*6
 - Approx flying weight: 1150g
 - Wing area: 36.5dm²
 - Wing loading: 31.5 g/dm²

The transmitter and model setup

Before getting started, bind your receiver with your transmitter. Please refer to your **Transmitter Manual** for proper operation.







CAUTION: To prevent personal injury, DO NOT install the propeller assembly onto the motor shaft while testing the control surfaces. DO NOT arm the ESC and do not turn on the transmitter until the **Transmitter Manual** instructs you to do so.

Get your model ready to fly

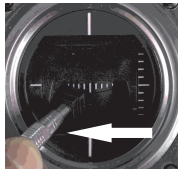
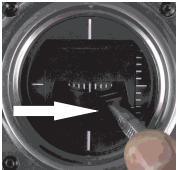
Tips: Make sure all control sticks on your radio are in the neutral position (rudder, elevator, ailerons) and the throttle in the OFF position. Make sure both ailerons move up and down (travel) the same amount. This model tracks well when the left and right ailerons travel the same amount in response to the control stick.

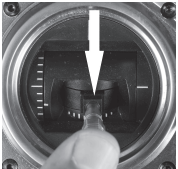
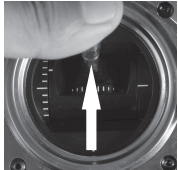
1. Move the controls on the transmitter to make sure aircraft control surface move correctly. See diagrams below. If controls respond in the opposite direction reverse the direction for operation of flight controls. Refer to your transmitter's instructions for changing direction of transmitter flight controls.
2. Adjust the servo arms mechanically make sure all servo arms are fully vertical. If not, adjust the servo arm by using the trim function on your radio.

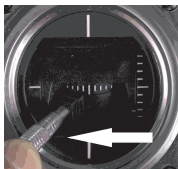
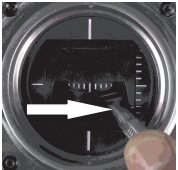
Note: For computerized transmitters, use the servo/channel sub-trim feature to make each servo arm fully vertical. Make sure the trims and the sub trims in neutral position before making some mechanically trim.

 	<p>Bank Left</p> <p>Bank Right</p>	 	Aileron
 	<p>Climb</p> <p>Descend</p>	 	Elevator
 	<p>Yaw Left</p> <p>Yaw Right</p>	 	Rudder Steering

3. Align the control surfaces well by adjusting the linkage rod in the control connector. The ailerons align with the wing root fillet, the counterbalance leading edge of the elevator aligns with the horizontal stabilizer leading edge and the counterbalance leading edge of the rudder with the vertical stabilizer leading edge.

Note: Use a drop of thread lock on the grub screws before securing the linkage rod.

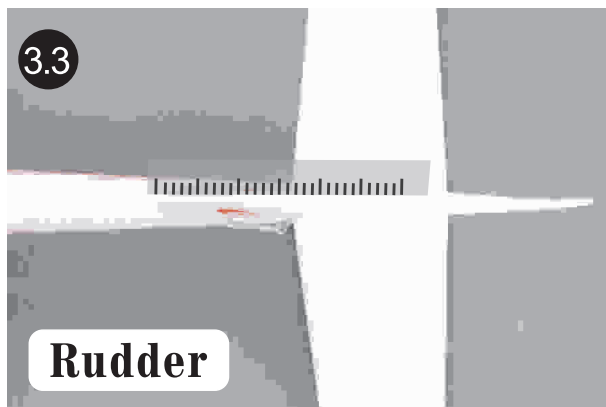
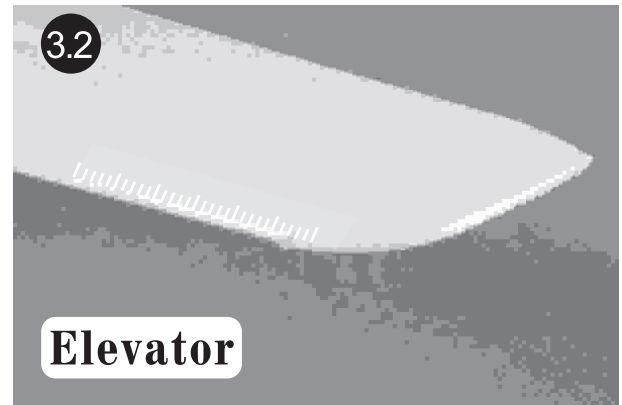
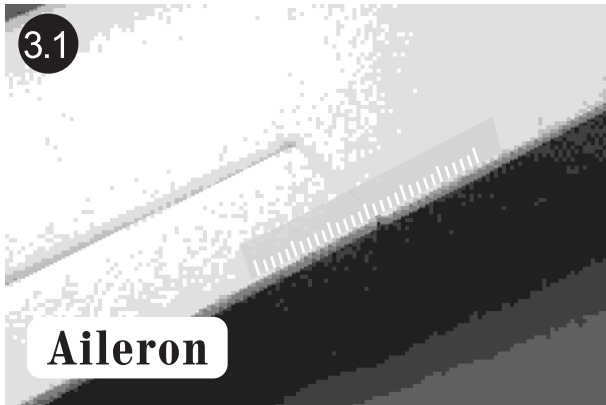

Check the motor rotating direction

1. The propeller should rotate clockwise when viewing the plane from the rear.
Note: Be careful not to accidentally discard the propeller hub adapter.
CAUTION: Before testing the propeller, make sure the tail of the plane is firmly on the model stand and ensure there are no people or objects in the range of the propeller.

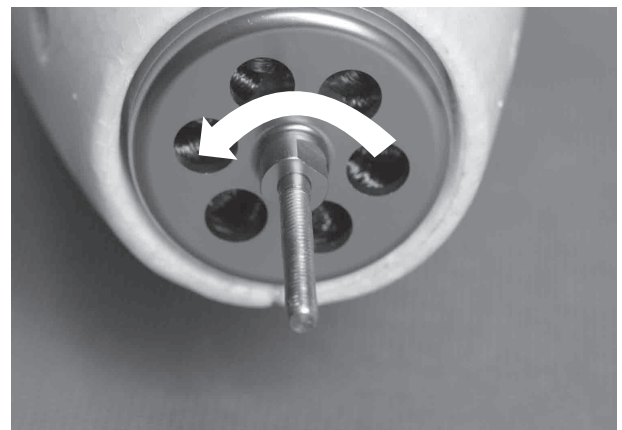

Check the C.G. (Center of Gravity)

Center of Gravity

When balancing your model, adjust the motor battery as necessary so the model is level or slightly nose down. This the correct balance point for your model. After the first flights, the **CG** position can be adjusted for your personal preference.

1. The recommended Center of Gravity (**CG**) location for your model is **(40mm)** forward from the leading edge of the main wing (as shown) with the battery pack installed. Mark the location of the **CG** on top of the wing.
2. When balancing your model, support the plane at the marks made on the bottom of the main wing with your fingers or a commercially available balancing stand. This is the correct balance point for your model. Make sure the model is assembled and ready for flight before balancing.

Caution: Do not connect the battery to the ESC while balancing the plane.

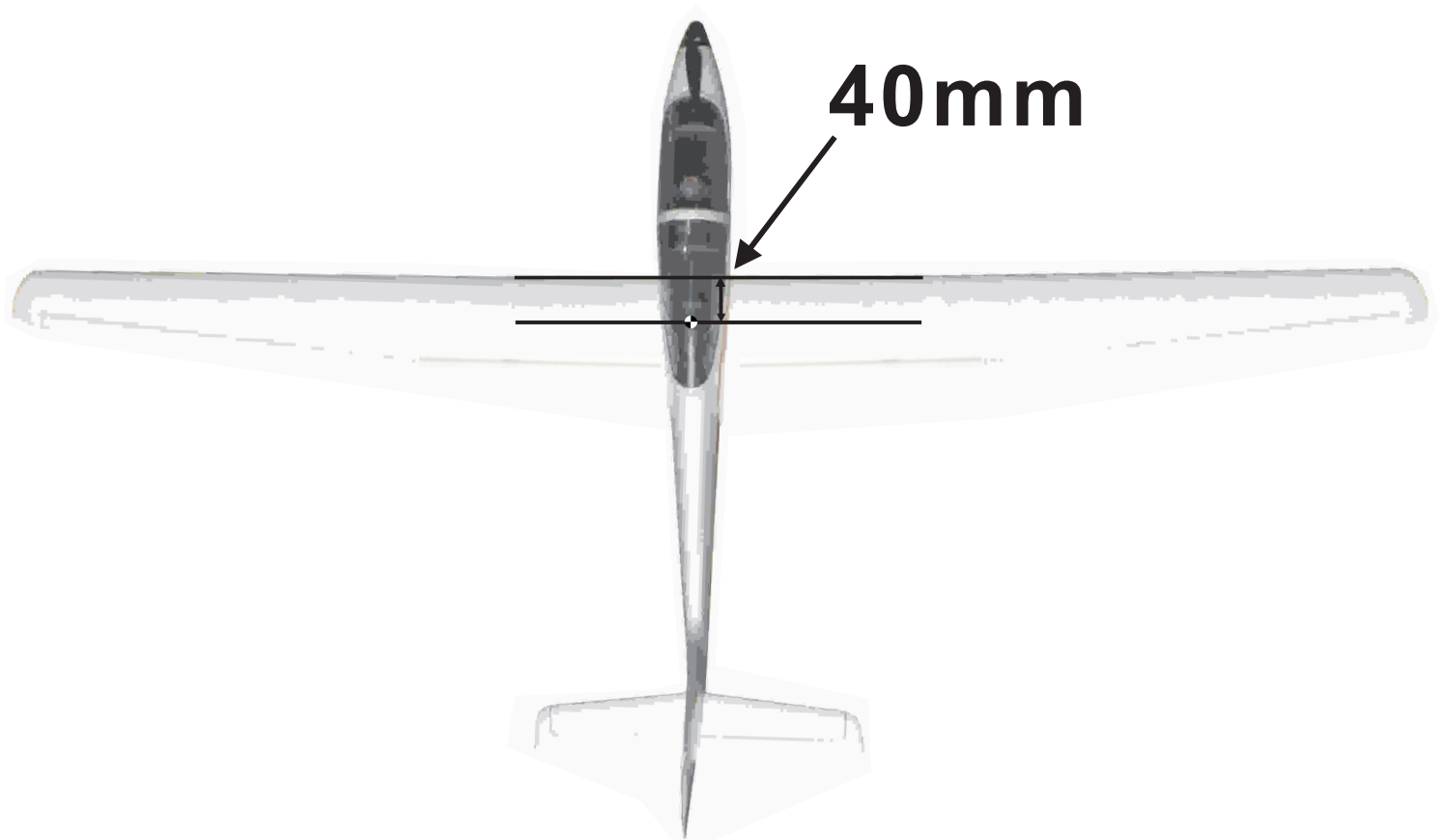

Before the model flying

Find a suitable flying site

Find a flying site clear of buildings, trees, power lines and other obstructions. Until you know how much area will be required and have mastered flying your plane in confined spaces, choose a site which is at least the size of two to three football fields – a flying field specifically for R/C planes is best. Never fly near people– especially children who can wander unpredictably.

Perform the range check of your plane

As a precaution, an operational ground range test should be performed before the first flight each time you go out. Performing a range test is a good way to detect problems that could cause loss of control such as low batteries, defective or damaged radio components, or radio interference. This usually requires an assistant and should be done at the actual flying site you will be using.

First turn on the transmitter, then install a fully-charged battery into the fuselage. Connect the battery and install the hatch.

Remember, use care not to bump the throttle stick, otherwise, the propeller / fan will turn and possibly cause damage or injury.

Note: Please refer to your **Transmitter Manual** that came with your radio control system to perform a ground range check. If the controls are not working correctly or if anything seems wrong, do not fly the model until you correct the problem. Make certain all the servo wires are securely connected to the receiver and the transmitter batteries have a good connection.

Monitor your flight time

Monitor and limit your flight time using a timer (such as one on a wrist watch or in your transmitter if available). When the batteries are getting low you will usually notice a performance drop before the ESC cuts off motor power, so when the plane starts flying slower you should land. Often (but not always) power can be briefly restored after the motor cuts off by holding the throttle stick all the way down for a few seconds.

To avoid an unexpected dead-stick landing on your first flight, set your timer to a conservative 4 minutes. When your alarm sounds you should land right away.

Flying course

Take off

While applying power slowly steer to keep the model straight, the model should accelerate quickly. As the model gains flight speed, you will want to climb at a steady and even rate. The **FOX** will climb out at a nice angle of attack (AOA).

Flying

Always choose a wide-open space for flying your plane. It is ideal for you to fly at a sanctioned flying field. If you are not flying at an approved site, always avoid flying near houses, trees, wires and buildings. You should also be careful to avoid flying in areas where there are many people, such as busy parks, schoolyards, or soccer fields. Consult laws and ordinances before choosing a location to fly your aircraft. After takeoff, gain some altitude. Climb to a safe altitude and begin to trim the model till it's tracks well through all aspects of flight, including high speed passes, inverted flight, loops, and point rolls.

Landing

Land the model when you hear the motor pulsing (LVC) or if you notice a reduction in power. If using a transmitter with a timer, set the timer so you have enough flight time to make several landing approaches.

Recharge the battery and repair the model as needed. The model's three point landing gear allows the model to land on hard surfaces. Align model directly into the wind and fly down to the ground. Fly the airplane down to the ground using 1/4-1/3 throttle to keep enough energy for proper flare. Before the model touches down, always fully decrease the throttle to avoid damaging the propeller or other components. The key to a great landing is to manage the power and elevator all the way to the ground and set down lightly on the main landing gear. After a few flights you will find the model can be set down lightly on the mains and you can hold the nose wheel off balancing the model on the mains till it slows and gently settles the nose.

Maintenance

Repairs to the foam should be made with foam safe adhesives such as hot glue, foam safe CA, and 5 min epoxy. When parts are not repairable, see the **Spare Parts List** for ordering by item number.

Always check to make sure all screws on the aircraft are tightened. Pay special attention to make sure the bullet of the rotor adaptor is firmly in place before every flight.

Troubleshooting

Problem	Possible Cause	Solution
Aircraft will not respond to the throttle but responds to other controls.	<ul style="list-style-type: none"> - ESC is not armed. - Throttle channel is reversed. 	<ul style="list-style-type: none"> - Lower throttle stick and throttle trim to lowest settings. - Reverse throttle channel on transmitter.
Extra propeller noise or extra Vibration.	<ul style="list-style-type: none"> - Damaged spinner, propeller, motor, or motor mount. - Loose propeller and spinner parts. - Propellor installed backwards. 	<ul style="list-style-type: none"> - Replace damaged parts. - Tighten parts for propeller adapter, propeller and spinner.
Reduced flight time or aircraft underpowered.	<ul style="list-style-type: none"> - Flight battery charge is low. - Propeller installed backward. - Flight battery damaged. 	<ul style="list-style-type: none"> - Remove and install propeller correctly. - Completely recharge flight battery. - Replace flight battery and obey flight battery instructions.
Control surface does not move, or is slow to respond to control inputs.	<ul style="list-style-type: none"> - Control surface, control horn, linkage or servo damage. - Wire damaged or connections loose. 	<ul style="list-style-type: none"> - Replace or repair damaged parts and adjust controls. - Do a check of connections for loose wiring.
Controls reversed.	Channels are reversed in the transmitter.	Do the Control Direction Test and adjust controls for aircraft and transmitter.
<ul style="list-style-type: none"> - Motor loses power. - Motor power pulses then motor loses power. 	<ul style="list-style-type: none"> - Damage to motor, or battery. - Loss of power to aircraft. - ESC uses default soft Low Voltage Cutoff(LVC). 	<ul style="list-style-type: none"> - Do a check of batteries, transmitter, receiver, ESC, motor and wiring for damage (replace as needed). - Land aircraft immediately and Recharge flight battery.
LED on receiver flashes slowly.	Power loss to receiver.	<ul style="list-style-type: none"> - Check connection from ESC to receiver. - Check servos for damage. - Check linkages for binding.

ESC instruction

Wires Connection:

The electronic speed controller can be connected to the motor by soldering directly or with high quality connectors. Always use new connectors, which should be soldered carefully to the cables and insulated with heat shrink tube. The maximum length of the battery pack wires shall be within 6 inches.

- Solder controller to the motor wires.
- Solder appropriate connectors to the battery wires.
- Insulate all solder connectors with heat shrink tubes.
- Plug the "JR" connector into the receiver throttle channel.
- Speed Controller Red and Black wires connects to battery pack Red and Black wires respectively.

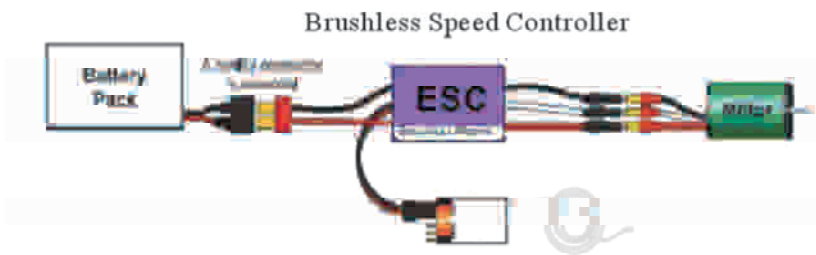

Specification:

Model #	Cont. Current(A)	Burst Current (A) 10s.	Battery cell NiXX/Lipo	Weight (g)	BEC Output	Size (mm) W*L*H	User Program
6A	6A	8A	5-10 NC \ 2-3 Lipo	5	5volts / 2amps	13 x 21 x 4	yes
12A	12A	16A	5-12 NC \ 2-4 Lipo	8	5volts / 1amps	21 x 22 x 4	yes
20A	20A	30A	5-12 NC \ 2-4 Lipo	18	5volts / 3amps	13 x 21 x 4	yes
30A	30A	40A	5-12 NC \ 2-4 Lipo	30	5volts / 3amps	23 x 43 x 6	yes
35A	35A	45A	5-12NC \ 2-4 Lipo	47	5volts / 4amps	28 x 38 x 8	yes
40A	40A	50A	5-12 NC \ 2-4 Lipo	44	5volts / 3amps	28 x 38 x 8	yes
45A	45A	55A	5-12 NC \ 2-4 Lipo	42	5volts / 3amps	31 x 58 x11	yes
50A	50A	70A	5-18NC \ 2-6 Lipo	45	5.5volts / 5amps	31 x 58 x 11	yes
60A	60A	70A	5-12NC \ 2-4Lipo	50	5.5volts / 3amps	36 x 50 x 8	yes
65A	65A	85A	5-18NC \ 2-6Lipo	58	5.5volts / 5amps	30 x 56 x 11	yes
70A	70A	75A	5-12NC \ 2-6 Lipo	56	5.5volts / 5amps	34 x 52 x 14	yes
85A	85A	100A	5-18NC \ 2-6Lipo	63	5.5volts / 5amps	34 x 52 x 14	yes

Features:

- ◆ Extremely low internal resistance
- ◆ Super smooth and accurate throttle linearity
- ◆ Safety thermal over-load protection
- ◆ Auto throttle shut down in signal loss situation
- ◆ Supports high RPM motors
- ◆ Power arming protection (prevents the motor from accidentally running when switched ON)
- ◆ New advanced programming software

Our ESC allows you to program parameters to fit your specific needs:

Our ESC allows you to program parameters to fit your specific needs:

1. User programmable brake setting (we recommend using brake for only folding props applications)
2. User programmable battery type (LiPo or NiCd/NiMh)
3. User programmable low voltage cutoff setting
4. User programmable factory default setting restore
5. User programmable timing settings (to enhance ESC efficiency and smoothness)
6. User programmable soft acceleration start ups (for delicate gearbox and helicopter applications)
7. User programmable governor mode (for helicopter applications)
8. User programmable motor rotation (clockwise\counterclockwise)
9. User programmable switching frequency
10. User programmable low voltage cutoff type (power reduction or immediate shutdown)

Settings:

1. Brake: ON/OFF

* ON-Sets the propeller to the brake position when the throttle stick is at the minimum position (Recommended for folding props).

* OFF-Sets the propeller to freewheel when the throttle stick is at the minimum position.

2. Battery type: LiPo or NiCad/NiMh

* NiCad/NiMh – Sets Low Voltage protection threshold for NiCad/NiMh cells.

* LiPo – Sets Low voltage protection threshold for LiPo cells and automatically detects the number of cells within the pack.

Note: Selecting the NiCad/NiMh option for the battery type, triggers the ESC to automatically set the cutoff threshold to the factory default of 65%. The cutoff threshold can then be subsequently altered through the Low Voltage protection function, if required. The ESC will read the initial voltage of the NiCad/NiMh pack once it is plugged in and the voltage read will then be used as a reference for the cutoff voltage threshold.

3. Low Voltage Protection Threshold (Cutoff Threshold):

Low / Medium / High

1) For Li-xx packs- number of cells are automatically calculated and requires no user input apart from defining the battery type. This ESC provides 3 setting options for the low voltage protection threshold; Low (2.8V)/ Medium (3.0V)/ High (3.2V). For example: the voltage cutoff options for an 11.1V/ 3 cell Li-Po pack would be 8.4V (Low)/ 9.0V (Med)/ 9.6V (High)

2) For Ni-xx packs-low / medium / high cutoff voltages are 50%/65%/65% of the initial voltage of the battery pack. For example: A fully charged 6 cell NiMh pack's voltage is $1.44V \times 6 = 8.64V$, when "LOW" cutoff voltage is set, the cutoff voltage is: $8.64V \times 50\% = 4.3V$ and when "Medium" or "High" is set, the cutoff voltage is now $8.64V \times 65\% = 5.61V$.

4. Restore factory setup defaults:

Restore - Sets the ESC back to factory default settings;

Brake :	Off
Battery type Detect :	LiPo with Automatic Cell
Low voltage cutoff threshold :	Medium (3.0V/65%)
Timing setup :	Automatic
Soft Acceleration Start Up :	Medium
Governor mode :	OFF
Frequency :	16kHz
Low voltage cutoff type :	Reduce power

5. Timing setup: Automatic / Low / High.

- * Automatic – ESC automatically determines the optimum motor timing
- * Low (7-22 deg) – Setting for most 2 pole motors.
- * High (22-30 deg)-setting for motors with 6 or more poles.

In most cases, automatic timing works well for all types of motors. However for high efficiency we recommend the Low timing setting for 2 pole motors (general in-runners) and high timing for 6 poles and above (general outrunners). For higher speed, High timing can be set. Some motors require different timing setups therefore we suggest you follow the manufacturer recommended setup or use the automatic timing setting if you are unsure.

Note: Run your motor on the ground first after making any changes to your motor timing!

6. Soft Acceleration Start ups: Very Soft / Soft Acceleration/ Start Acceleration

- * Very Soft – Provides initial slow 1.5 sec ramp-up from start to full rpm intended to protect delicate gears from stripping under instant load. This setting is recommended for either fixed wing models equipped with gearboxes and / or helicopters.
- * Soft Acceleration- Provides initial slow 1 sec ramp-up from start to full rpm. This setting is recommended for either fixed wing models equipped with gearboxes and or helicopters.
- * Start Acceleration – Provides quick acceleration start ups with a linear throttle response. This is recommended for fixed wing models fitted with direct drive setups.

7. Active RPM Control (Heli Governor Mode)

- * RPM control off

* **First range:** There will be a 5-second delay from start to full rpm, but if the throttle is cutoff after starting, then the next start will be as normal start.

* **Second range:** There will be a 15-second delay from start to full rpm, but if the throttle is cutoff after starting, then the next start will be as normal start.

Note: Once the Governor Mode is enabled, the ESC's Brake and Low Voltage Cutoff Type settings will automatically be reset to No Brake and Reduce Power respectively regardless of what settings they were previously set.

8. Motor Rotation: Reverse

In most cases motor rotation is usually reversed by swapping two motor wires. However, in cases where the motor cables have been directly soldered to the ESC cables, motor rotation can be reversed by changing the value of setting on the ESC.

9. Switching Frequency: 8 kHz/16kHz

- * 8 kHz – Sets ESC switching frequency for 2 pole motors, e.g. in-runners.
- * 16 kHz – Sets ESC switching frequency for motors with more than 2 poles, e.g. out-runners.

Although 16 kHz is more efficient without Thrust motors, the setup default is 8 kHz due to the higher RF noises caused at 16 kHz.

10. Low Voltage Cutoff Type: Reduce Power / Hard cutoff

- * Reduce Power – ESC reduces motor power when the pre-set (recommended).
- * Hard Cutoff – ESC instantly cuts motor power when the pre-set Low Voltage Protection Threshold value is reached.

Programming Mode Audible Tones

Programming Mode Audible Tones	ESC Functions
0 Throttle Calibration (within the first 4 Sec) ● ● ● ●	

1	Brake * * * *	Brake On /Off
2	Battery type ~ ~ ~ ~ ~ ~ ~ ~	NiCad LiPo
3	Low Voltage Cutoff Threshold *	Low 2.8V/50% Medium 3.0V/60% High 3.2V/65%
4	Restore Factory Setup Defaults _ _ _ _ _	Restore
5	Timing Setup _ _ _ _ _ _ _ _ _ _ _ _	Automatic (7-30°) Low (7-22°) High (22-30°)
6	Soft Acceleration Start Ups ∨	Very Soft Soft Acceleration Start Acceleration
7	Governor Mode * * * * ** ** ** ** *** *** *** **	Rpm off Heli first range Heli second range
8	Motor Rotation W W W W	Positive/Reverse
9	Switching Frequency // // // // \\ \\ \\ \\	8kHz 16kHz
10	Low Voltage Cutoff Type X X X X X X X X	Reduce Power Hard Cut Off

Using Your New ESC

Improper polarity or short circuit will damage the ESC therefore it is your responsibility to double check all plugs for proper polarity and firm fit BEFORE connecting the battery pack.

Alert Tones

The ESC is equipped with audible alert tones to indicate abnormal conditions at power up.

If the ESC can't enter into working mode after powering up, indicates that you have not setup throttle calibration.

1. Continuous beeping tone (****) – Indicates that the throttle stick is not in the minimum position.
2. Single beeping tone followed by a one second pause (* * * *) – Indicates that the battery pack voltage is not within the acceptable range. (The ESC automatically checks and verifies the battery voltage once the battery is connected).
3. A single beeping tone followed by a short pause (* * * *) – Indicates that the ESC is unable to detect the normal throttle signal from the receiver.

Built-in Intelligent ESC Safety Functions

1. Over-heat protection: When the temperature of ESC exceeds 110 deg C, the ESC will reduce the output power to allow it to cool.
2. Lost Throttle signal protection: The ESC will automatically reduce output power to the motor when it detects a lost

of throttle signal for 2 second, a subsequent loss of throttle signal beyond 2 seconds, will cause the ESC automatically to cut power to the motor.

Powering up the ESC for the first time and setting the Automatic Throttle Calibration

The ZTW ESC features Automatic Throttle Calibration to attain the smoothest throttle response and resolution throughout the entire throttle range of your transmitter. This step is done once to allow the ESC to “learn and memorize” your Transmitter’s throttle output signals and only repeated if you change your transmitter.

1. Switch your Transmitter ON and set the throttle stick to its maximum position.
2. Connect the battery pack to the ESC. **Wait for about 2 seconds, the motor will beep for twice, then put the throttle in the minimum position, the motor will also beep, which indicates that your ESC has got the signal range of the throttle from your transmitter.**

The throttle is now calibrated and your ESC is ready for operation.

Normal ESC start up procedure:

1. Switch your Transmitter **ON** and set the throttle to its minimum position.
2. Connect the battery pack to the ESC.
3. When the ESC is first powered up, it emits two sets of audible tones in succession indicating the status of its programming state.
 - * The first set of tones denotes the number of cells in the LiPo pack connected to the ESC. (Three beeps (***) indicates a 3 cell LiPo pack while 4 beeps (****) indicates a 4 cell LiPo pack).
 - * The second set denoting Brake status. One beep (*) for Brake “ON” and two beeps (**) for Brake “OFF” .
 - * The ESC is now ready for use.

Entering the Programming Mode:

1. Switch your Transmitter **ON** and set the throttle to its maximum position.
2. Connect the battery pack to the ESC.
3. Wait until you hear two short beeps (_ _ **) confirming that the ESC has now entered the programming mode.
4. If within 5 seconds, the throttle stick is lowered to its minimum position, an audible tone is emitted confirming that the **throttle calibration** setting has changed. If the throttle stick is left in the maximum position beyond 5 seconds, the ESC will begin the sequence from one function and its associated setting options to another. (Please refer to the table below to cross reference the functions with the audible tones).
5. When the desired tone for the function and setting option is reached, move the throttle stick down to its minimum position. ESC will emit two beeps (**) confirming the new setting has been stored.
6. The ESC only allows the setting of one function at a time. Therefore should you require making changes to other functions disconnect the battery pack and wait 5 seconds to reconnect the battery and repeat the above steps.

General Safety Precautions

Do not install the propeller (fixed wing) or drive pinion (helicopter) on the motor when you test the ESC and motor for the first time to verify the correct settings on your radio. Only install your propeller or pinion after you have confirmed that the settings on your radio is correct.

- Never use ruptured or punctured battery cells.
- Never use battery packs that are known to overheat.
- Never short circuit battery or motor terminals.
- Always use proper insulation material for cable insulation.
- Always use proper cable connectors.
- Do not exceed the number of cells or servos specified by the ESC.

Wrong battery polarity will damage the ESC and void the warranty.

- Install the ESC in a suitable location with adequate ventilation for cooling. This ESC has a built-in over heat cutoff protection feature that will immediately cut power to the motor once the ESC temperature exceeds the 230 Deg F/ 110 Deg C high temperature limit.
- Use only batteries that are supported by the ESC and ensure the correct polarity before connecting.
- Switch your Transmitter ON and ensure the throttle stick is in the minimum position before connecting the battery

pack.

- Never switch your transmitter **OFF** while the battery is connected to your ESC.
- Only connect your battery pack just before flying and do not leave your battery pack connected after flying.
- Handle your model with extreme care once the battery pack is connected and keep away from the propeller at all times. Never stand in-line or directly in front of any rotating parts.
- Do not immerse the ESC underwater while powered up.
- Do fly at a designated flying site and abide by the rules and guidelines set by your flying club.

Troubleshooting:

Issue	Possible Reason	Action
Motor doesn't work, but there are audible tones of automatically detection of the number of cells after powering up ESC.	The ESC throttle calibration has not set up.	Set up the ESC throttle calibration.
Motor doesn't work and no audible tone emitted after connecting the battery. Servos are not working either.	Poor/loose Connection between battery Pack and ESC.	Clean connector terminals or replace connector.
	No power	Replace with a freshly charged battery pack
	Poor soldered connections (dry joints)	Re-solder the cable connections
	Wrong battery cable polarity	Check and verify cable polarity
	ESC throttle cable connected to receiver in the reverse polarity	Check the ESC cable connected to the ESC to ensure the connectors are in the correct polarity.
	Faulty ESC	Replace ESC
Motor doesn't work and no audible tone emitted after connecting the battery BUT servos are working.	Poor / loose connection between ESC and motor	Clean connector terminals or replace connectors
	Burnt motor coils	Replace motor
Motor doesn't work after powering up the ESC. An alert tone with two beeping bones followed by a short pause (** ** ** **) is emitted.	Poor soldered connections(dry joints) The battery pack voltage is not within the acceptable range.	Re-solder the cable connections Replace with a freshly charged battery pack Check battery pack voltage
Motor doesn't work after powering up the ESC. An alert tone with a single beeping tone followed by a short pause (* * *) is emitted.	The ESC is unable to detect the normal throttle signal from the receiver	Check and verify that the ESC cable is connected to the <u>Throttle</u> channel on the receiver. Check the transmitter and receiver to verify that there is throttle signal output. (Connect a spare servo to verify throttle channel operation)
Motor doesn't work after powering up the ESC .An alert tone with continuous beeping tones (****) is emitted.	The throttle stick is not in the <u>minimum</u> position at power up.	Move the throttle stick to the minimum position.
Motor doesn't work after powering up the ESC. ESC emits two long audible tones followed by two short beeps(_ _ * *)	Reversed throttle channel caused the ESC to enter the programming mode.	Enter the servo reverse menu on your transmitter and reverse the throttle channel. Note: For Futaba radios set the throttle channel to Reverse.

Issue	Possible Reason	Action
Motor runs in reverse rotation Motor stops running in flight.	Wrong cables polarity between the ESC and the motor.	Swap any two of the three cable connections between the ESC and the Motor or __ access the Motor Rotation function via the ESC programming mode and change the pre-set parameters.
	Lost throttle signal	Check proper operation of the radio equipment. Check the placement of the ESC and the Receiver and check the route of the receiver' s aerial and ESC cables to ensure there is adequate separation to prevent RF interference. Install a ferrite ring on the ESC' s throttle cable.
	Battery Pack voltage has reached the Low Voltage Protection threshold.	Land the model immediately and replace the battery pack.
	Possible bad cable connection	Check and verify the integrity of the cable connections
Motor restarts abnormally ESC Overheats	Possible RF Interference at the flying field.	The normal operation of the ESC may be susceptible to surrounding RF interference. Restart the ESC to resume normal operation on the ground to verify recurrence. If the problem persists, test the operation of the ESC at a different flying field.
	Inadequate Ventilation	Relocate the ESC to allow better ventilation
	Servos drawing too much current and over loading the ESC.	Use servos that are adequately sized for the ESC. The maximum BEC current drawn should be within the BEC limits.
	Over sized motor or prop	Prop down or resize the motor



MADE IN CHINA