

SPY HAWK

NO.: H301S



2.4GHz R/C SERIES 4 CHANNEL
5.8GHz FPV/FIRST PERSON VIEW

CATALOG

INCLUDED ACCESSORIES	02
EXPLODING VIEW	02
SAFETY NOTES	02
ASSEMBLY INSTRUCTIONS	04
CHARGING THE LI-PO BATTERY	06
2.4GHz & 5.8GHz TRANSMITTER	07
5.8GHz TECHNICAL TIPS	10
HOW TO LAUNCH	11
VIDEO RECORDING	14
ADVANCE PERFORMANCE SET UP	15
H301S TROUBLESHOOTING	17
H301S SPARE PARTS CHART	20

FCC Information

This equipment has been tested and found to comply with the limits for a Class B digital device, pursuant to Part 15 of the FCC Rules. These limits are designed to provide reasonable protection against harmful interference in a residential installation. This equipment generates, uses, and can radiate radio frequency energy and, if not installed and used in accordance with the instructions, may cause harmful interference to radio communications. However, there is no guarantee that interference will not occur in a particular installation. If this equipment does cause harmful interference to radio or television reception, which can be determined by turning the equipment off and on, the user is encouraged to try to correct the interference by one or more of the following measures:

- Reorient or relocate the receiving antenna.
- Increase the separation between the equipment and receiver.
- Connect the equipment into an outlet on a circuit different from that to which the receiver is connected.
- Consult the local dealer or an experienced radio/TV technician for help.

Changes or modifications not expressly approved by the party responsible for compliance could void the user's authority to operate the equipment.

This device complies with Part 15 of the FCC Rules. Operation is subject to the following two conditions: (1) this device may not cause harmful interference, and (2) this device must accept any interference received, including interference that may cause undesired operation.

Electrical and electronic equipment that are supplied with batteries (including internal batteries)

WEEE Directive & Product Disposal

At the end of its serviceable life, this product should not be treated as household or general waste. It should be handed over to the applicable collection point for the recycling of electrical and electronic equipment, or returned to the supplier for disposal.

Internal / Supplied Batteries.

This symbol on the battery indicates that the battery is to be collected separately.

This battery is designed for separate collection at an appropriate collection point.



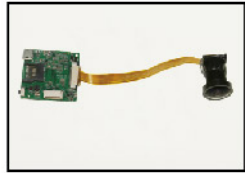

H301S-17
Camera module

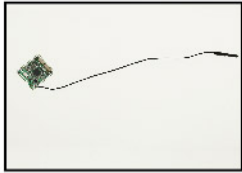

H301S-18
5.8GHz TX module



H301S-19
Lipo battery

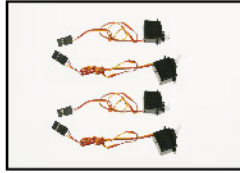

H301S-20
Servo set



H301S-21
Linkage wires



H301S-22
LED light bars



H301S-23
SD Card



H301S-24
Body stickers

Included Accessories

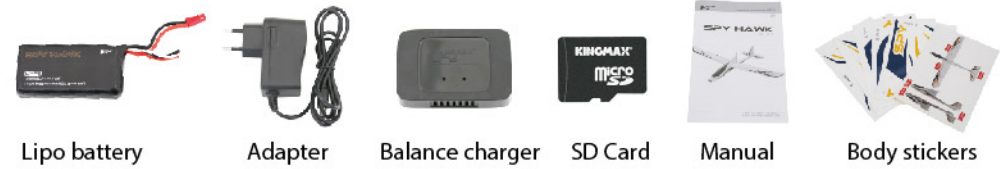

Exploding View

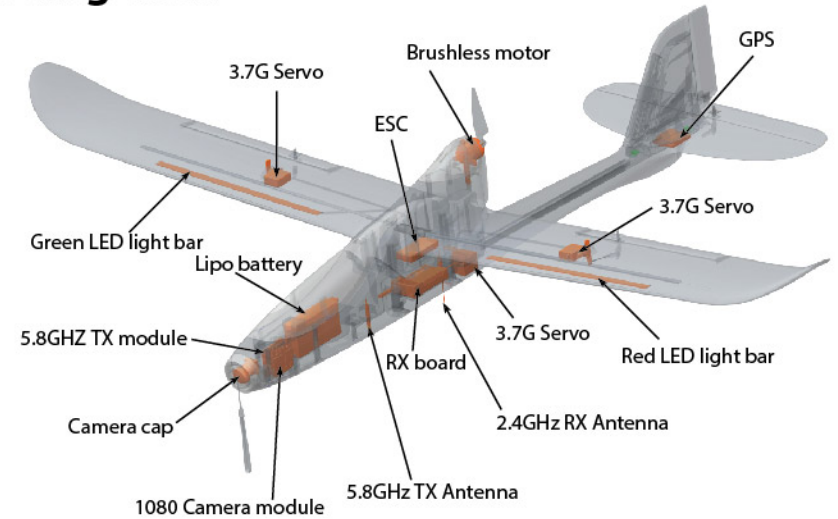

1 SAFETY NOTES

Thanks for buying HUBSAN products.

1.1 Important Notes

This RC Spy Hawk is not a toy. Any improper use of this product will result in serious injury. Be aware of your personal safety, safety to others and your surrounding environment.

We recommend beginners learn to fly with more experienced pilots playing nearby before attempting to fly the spy hawk for the first time.

1.2 LiPo Battery Safety Notes

The Spy Hawk is powered by a lithium-polymer(Lipo) battery.

To avoid risk of fire or damage, never recharge your battery while it is inserted in the plane. If you do not plan to fly the plane for a week or more, store the battery approximately 50% charged to maintain battery performance and life.



SAFETY ADVISORY NOTICE

Lithium-Polymer (LiPo) Batteries

LiPo batteries are different from conventional batteries in that their chemical contents are encased in a relatively lightweight foil packaging. This has the advantage of significantly reducing their weight, but does make them more susceptible to damage if roughly or inappropriately handled. As with all batteries, there is a risk of fire or explosion if safety practices are ignored:

- ☑ Charge and store LiPo batteries in a location where a battery fire or explosion (including smoke hazard) will not endanger life or property.
- ☑ Keep LiPo batteries away from children and animals.
- ☑ Never charge the LiPo battery that has ballooned or swelled.
- ☑ Never charge the LiPo battery that has been punctured or damaged.
- ☑ After a crash, inspect the battery pack for the sign of damage. Discard in accordance with your country's recycling laws.
- ☑ Never charge the LiPo battery in a moving vehicle.
- ☑ Never overcharge the LiPo battery.
- ☑ Never leave the LiPo battery unattended during recharging.
- ☑ Do not charge LiPo batteries near flammable materials or liquids.
- ☑ Ensure that charging leads are connected correctly. Reverse polarity charging can lead to battery damage or a fire or explosion.
- ☑ Have a suitable fire extinguisher (electrical type) OR a large bucket of dry sand near the charging area. Do not try to extinguish electrical (LiPo) battery fires with water.
- ☑ Reduce risks from fire/explosion by storing and charging LiPo batteries inside a suitable container.
- ☑ Protect your LiPo battery from accidental damage during storage and transportation. (Do not put battery packs in pockets or bags where they can short circuit or can come into contact with sharp or metallic objects.)
- ☑ If your LiPo battery is subjected to a shock (such as a crash), place it in a metal container and observe for signs of swelling or heating for at least 30 minutes.
- ☑ Do not attempt to disassemble or modify or repair the LiPo battery.

H301S SPARE PARTS CHART

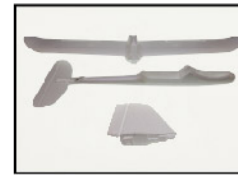

H301S-01
EPO Body Kit

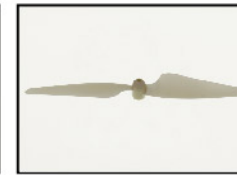

H301S-02
Propeller

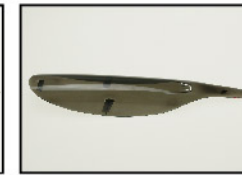

H301S-03
Canopy

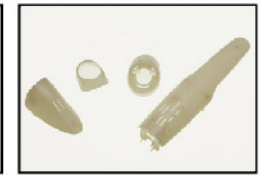

H301S-04
Camera Cap and
motor sleeve set

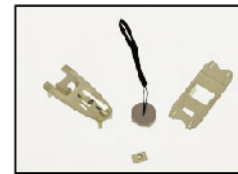

H301S-05
Camera sleeve set

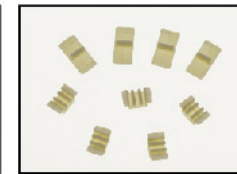

H301S-06
Buckles set

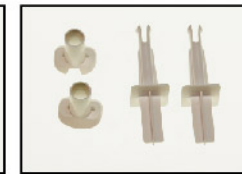

H301S-07
Linkage set

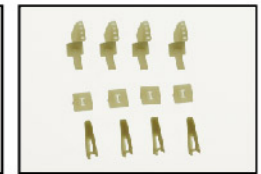

H301S-08
Servo sleeve set



H301S-09
Push rod



H301S-10
Screw set



H301S-11
Adapter



H301S-12
Balance charger

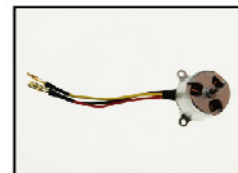

H301S-13
Brushless motor

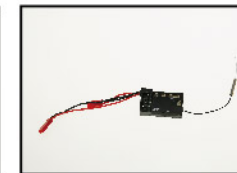

H301S-14
RX

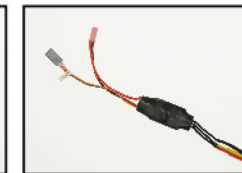

H301S-15
ESC



H301S-16
GPS module

Do not enter into the transmitter setting status during flight! The controller will not transmit a signal in the setting status. Carefully start the recording function key by just briefly clicking the "ENTER" key. Do not press the "ENTER" key more than 1 second or the controller will stop transmitting!

Question 13: The values on each channel showing on the LCD screen are not correct.

Answer:

(MODE 1 transmitter)

Push the left joystick to the top on the left, and the right joystick to the top on the right, keep them in this position and then turn on the transmitter, the LCD screen will show "CALIBRATE STICK", Move the joysticks in a circling motion about 3 times, and then release the joystick and press "EXIT" key to save and exist.

(MODE 2 transmitter)

Push the two joysticks to the top on the left and keep them in this position, and then turn on the transmitter, the LCD screen will show "CALIBRATE STICK", Move the joysticks in a circling motion about 3 times, and then release the joystick and press "EXIT" key to save and exist.



(MODE 1 transmitter)



(MODE 2 transmitter)

Question 14: The transmitter will not power on.

Answer:

Check the battery connection.

If the transmitter battery power is low, you will need to replace with new AA batteries or any 2S or 3S Lipo battery fitted with a JST connector.

2. ASSEMBLY INSTRUCTIONS

The air plane is already 90% pre-assembled so there is little to do before flight. Please refer to the following assembly steps to assemble your Air Plane.

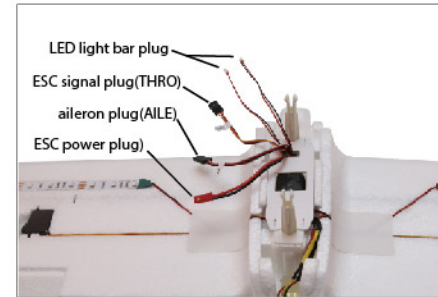

1、 See the above directions on the Main Wing

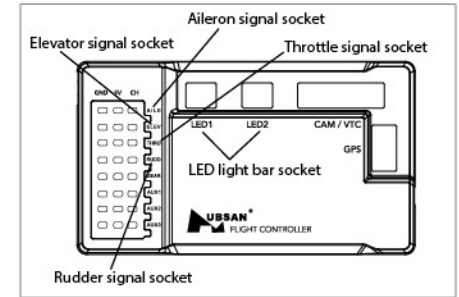

2、 See the above direction on the Receiver PCB board

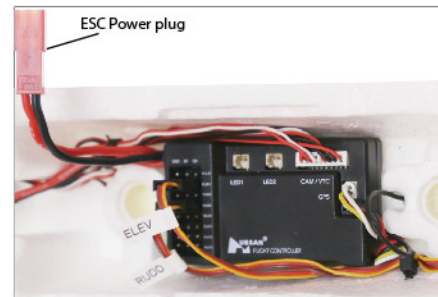

3、 Receiver PCB board in main body

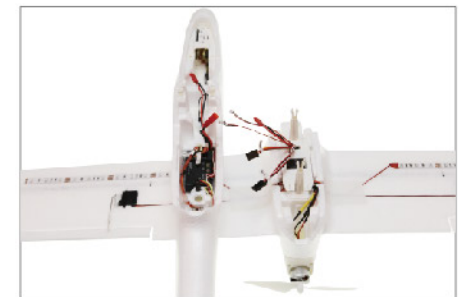

4、 Connect the wires accordingly, be aware of the direction and follow the notes

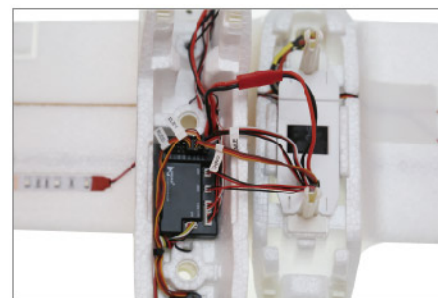

5、 Finish the linkage as the above picture

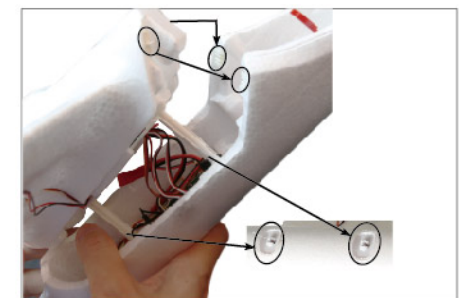

6、 Snap-fit the Main Wing and the Main Body (sort out the wires)



7、 Insert the battery into the compartment



8、 Connect the plugs



9、 Lay the canopy, aim into the buckles



10、 Put on the body stickers



11、 Open the camera cap before recording



12、 The camera cap can hang on the Transmitter's handle

The parameters of the stabilization system are factory preset, no need for initialization.

Question 6: The LCD screen is not viewable outdoors with bright sunshine.

Answer:

Check the packaging inside the box, there is an anti-glare sticker, it will help you to reduce glare in full sunshine. Peel the protective membrane and put it onto the screen.

Question 7: The battery life is too short and the battery will not charge.

Answer:

The Lipo battery has a protective voltage safety board with a cut off function. Once the Lipo battery's individual cell voltage drops below 3 volts, you will need to use an intelligent charger to revive the battery.

Question 8: The video is not being saved to the SD card.

Answer:

Always stop the video recording function and power off the battery first. After that you can take out the SD card.

Always turn off the power to the Air Plane before inserting or removing the SD card. This allows the memory to be properly saved to the SD card.

Question 9: I can not launch the airplane.

Answer:

The direction and strength of the wind will have a great effect on the flight performance of your model. Launch and release your airplane against the wind with its nose pointing slightly above the horizon. The wind speed should be not more than 3M/S.

Question 10 : The servos are getting too hot with noise.

Answer:

Check all connections on the pushrods, servo arm and servo horn for smooth operation and adjust the connections as required. Adjust the servo travel on each channel, or reduce the sensitivity on each channel in the transmitter settings.

Question 11: It is not arming after binding.

Answer:

Minimize the throttle to zero, or adjust the throttle trim to zero.

Question 12: The airplane out of control during flight

Answer:

H301S TROUBLESHOOTING

Question 1: The Air Plane dives when switching on/off the autopilot button.

Answer:

Always check the rudder, aileron and elevator both on stabilization status and non-stabilization status if you would like to switch on/off autopilot mode during flight.

Rudder, aileron and elevator need to be adjusted in the same position for stabilization status and non-stabilization status. Check the receiver module inside the fuselage, If this board not mounted in horizontally, correct it and glue it properly back in place.

Question 2: Black Video

Answer:

Re-bind the transmitter with your Spy Hawk.

If the recording module become overheated, please check to see if the cooling-event blocked. Check for any loose cables on the recording module.

Do not keep your airplane in the rest more than 2 minutes, as the recording module needs intake airflow for better cooling. The LCD on transmitter will go dark if the temperature of the recording module is over 60°C.

If the transmitter battery power is low, you will need to replace them with new AA batteries or any 2S or 3S Lipo battery that has a JST connector.

Question 3: Blue Video

Answer:

Out of the video range, always face the Air Plane as the video signal transmission is directional and needs direct line of site.

Check for any cable being loose on the 5.8Ghz TX module inside the fuselage of Air Plane.

Keep the 5.8 GHz antenna under the fuselage of the Air Plane and check to see that the antenna is pointed straight down.

Question 4: Why can't I perform aerobatics?

Answer:

Your Spy Hawk is designed for beginners only. It is a flying video platform and therefore the stabilization of the Air Plane was designed.

You can switch off the stabilization system and enter manual control system.

Question 5: Do I need to initialize the autopilot/stabilization system?

Answer:

3. CHARGING THE LI-PO BATTERY

The Air Plane is equipped with a LiPo battery:

3.1 7.4V 2 Cell 1300mAh x 1 unit



Connect battery to balance charger and wall charger, the two LED lights will turn red whilst charging and turn green when charging is finished, charging time is around 120 min.

3.2 Always partially charge your LiPo battery before storage.

LiPo batteries retain a charge over a reasonable period; It is not normally necessary to recharge stored LiPo batteries unless stored for periods longer than 3-6 months.

If your LiPo battery has been over-discharged, it will not be possible to recharge it again.



LiPo Battery Disposal & Recycling



Lithium-Polymer (LiPo) batteries must not be placed in with household trash. Please contact your environmental or waste agency or the supplier of your model for local regulations and the location of your nearest LiPo battery recycling center.

4. 2.4GHZ & 5.8GHZ TRANSMITTER

4.1 Identification and functions

Main Menu

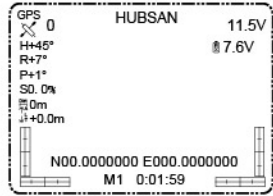

MODE 1

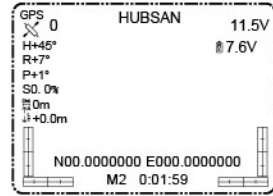

MODE 2

TRANSMITTER

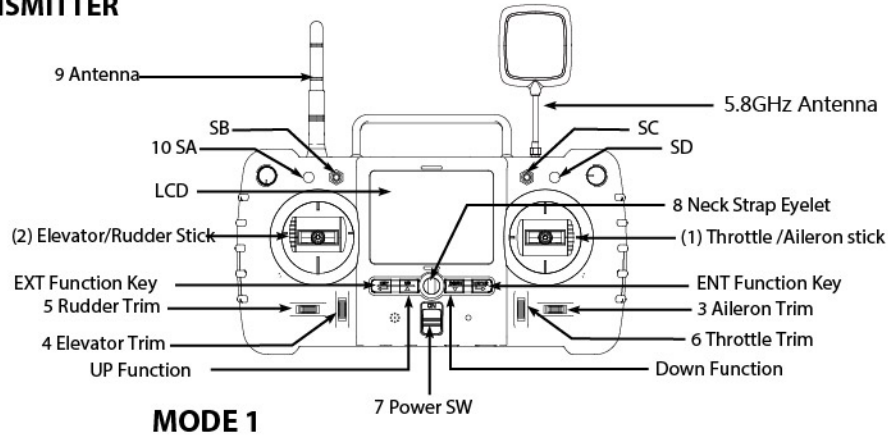

MODE 1

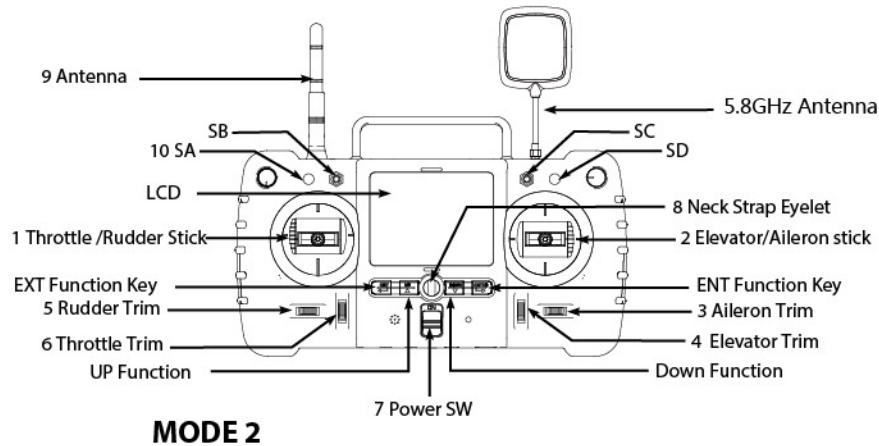

MODE 2

8.2 Expert mode

In expert mode, the sensitivity can be adjusted even further (up to 100) to give the user even more ability to manoeuvre the Air Plane. Follow instructions below to switch this on/off.

Hold the ENT key for 1 second to enter the settings menu. Move the arrow to "Expert mode" with the up/down keys. Press ENT to switch between Yes and No for turning the expert mode on or off.

HUBSAN	
Set reverse	X
Set sensitive	X
Plane type	air plane
→ Expert mode	Yes
Stick mode	Mode 2

8.3 Sensitivity set up

Your Hubsan transmitter can operate other selected Air Plane types within the Hubsan range. If you should need to change the modes to fly a different model follow the instructions below.

Hold the ENT key for 1 second to enter the settings menu. Move the arrow to "Plane type" with up/down keys. Press enter to switch between Airplane and the Helicopter. Hold the EXT key for 1 second to confirm and exit.

HUBSAN	
Set reverse	X
→ Set sensitive	X
Plane type	air plane
Expert mode	Yes
Stick mode	Mode 2

8. ADVANCE PERFORMANCE SET UP

8.1 Mode 1 and Mode 2 Reversing setup



1) Open the cover of transmitter by unscrewing the 4 screws as picture shows.

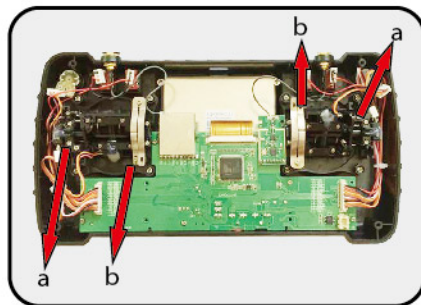

2) Screw a/b in the TX

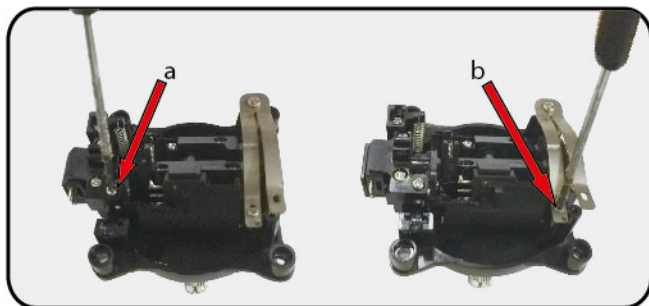

3) Fasten the screw a on the Spring and the screw b on the Shrapnel, the stick will be Throttle Stick; Loosen the screw a on the Spring and the screw b on the Shrapnel, the stick will be non Throttle Stick.

Hold down ENT key for 1 Second to enter setting status.

Press the ENT key to enter reverse setting status.

Move arrow to Stickmode with up/down key, push the left stick from up to down 3 times, the Mode 2 will change to Mode 1 automatically, Press EXT key to confirm and exit, Power off/on again and it will work as changed.

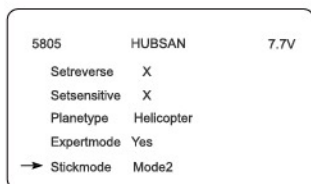

4.2 Input Key Function

S/N	Identification	Function
1	Throttle/Rudder Stick	Forward and backward movement of the stick will make the Air Plane increase or decrease speed respectively. Left and right movement of the stick makes the Air Plane yaw left/right respectively.
2	Elevator/Aileron Stick	Forward and backward movement of the stick makes the Air Plane nose point up/down respectively. Left and right movement of the stick makes the Air Plane roll left/right to initiate a turn.
(1)	Throttle /Aileron stick	Forward and backward movement of the stick will make the Air Plane increase or decrease speed respectively. Left and right movement of the stick makes the Air Plane roll left/right to initiate a turn.
(2)	Elevator/Rudder Stick	Forward and backward movement of the stick makes the Air Plane nose point up/down respectively. Left and right movement of the stick makes the Air Plane yaw left/right respectively.
3	Aileron Trim	Aileron trim adjusts left and right roll.
4	Elevator Trim	Elevator trim adjusts up and down movement.
5	Rudder Trim	Rudder trim adjusts left and right yaw.
6	Throttle Trim	Throttle trim adjusts speed of motor.
7	Power SW	Pushing the switch up powers on the transmitter, pulling it down switches it off.
8	Neck Strap Eyelet	For the attachment of a neck strap which eases the tension of your hands from holding the transmitter.
9	Antenna	Transmits the 2.4Ghz wireless signal.
10	SA	GPS function: Push SA, the plane will return to home; Pull SA, the RTH function turns off.
11	SB/SC/SD	No function for now.
12	DSC (Optional)	Connects to the data cable of computer simulator.

4.3 Battery mounting

Notice:

- >Do not mix old and new batteries
- >Do not mix different types of batteries
- >Do not charge non-rechargeable battery.

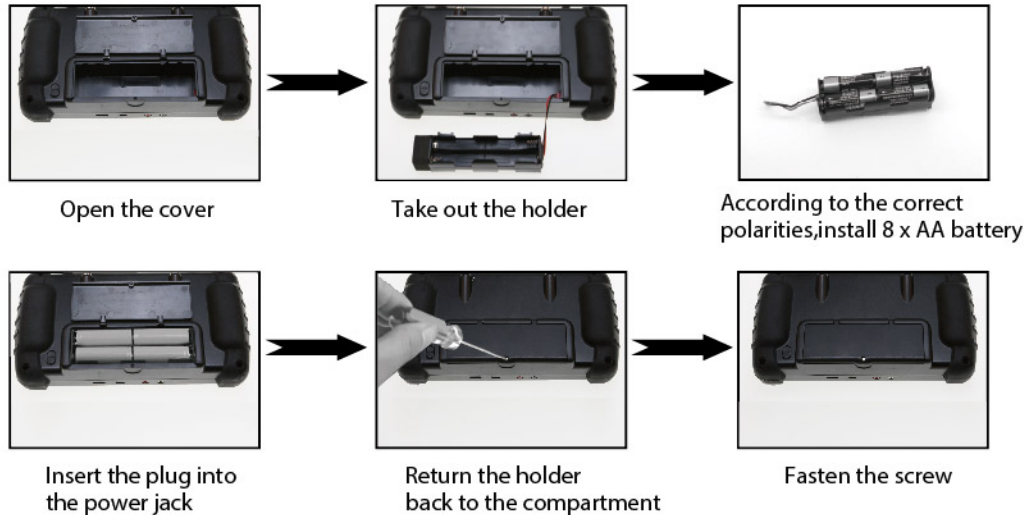

4.4 Transmitter Stick Calibration

(MODE 1 transmitter)

Push the left joystick to the top on the left, and the right joystick to the top on the right, keep them in this position and then turn on the transmitter, the LCD screen will show "CALIBERATE STICK", Move the joysticks in a circling motion about 3 times, and then release the joystick and press "EXIT" key to save and exist.

(MODE 2 transmitter)

Push the two joysticks to the top on the left and keep them in this position, and then turn on the transmitter, the LCD screen will show "CALIBERATE STICK", move the joysticks in a circling motion about 3 times, and then release the joystick and press "EXIT" key to save and exist.



(MODE 1 transmitter)



(MODE 2 transmitter)

7. VIDEO RECORDING

Note:

Always turn OFF the Air Plane's power before inserting or removing the SD card.

Always stop the video recording function and power off the battery firstly, and then you can take out the SD card.

7.1.1 Remove the canopy to locate the SD card slot



7.1.4 When the red dot become the recording logo, indicating recording stopped

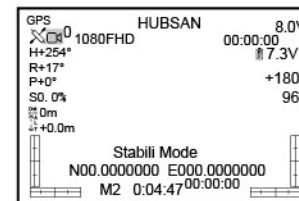

7.1.2 Insert the SD card

Note: Avoid removing the SD card and re-inserting again too quickly otherwise the recording module will not work properly

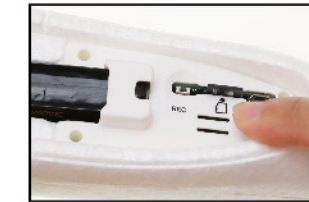

7.1.5 You can start/stop recording by either pressing the button next to the SD card slot on the Air Plane or using the remote



7.1.3 Recording time:

The red dot blinking, indicating recording started, and the video recording time will start to count

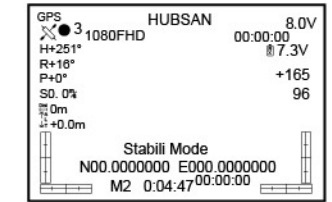

7.1.6 Using Enter button on Remote control to stop/start recording



WARNING:

Try to avoid letting the Air Plane rest for any longer than 2 minutes, otherwise the camera module will OVERHEAT! This will result the screen on the remote going dark and poor quality recordings.

There are cooling vents on the canopy to keep the camera module below 60 C. DO NOT cover this vent or prevent the air flow into the camera compartment.

While if the GPS value shows NA, indicating the GPS is not connected or broken, need to check the connect wires and the GPS module. The plane can take off without GPS function, only in that way the Return to Home function is useless.

6.3 Launch the plane

6.3.1 The direction and strength of the wind will have a great effect on your model. Always launch your Air Plane into/against the direction of the wind.

6.3.2 Keep the Air Plane horizontal(the nose slight pointing above the horizon) push the throttle to the upmost, throw the Air Plane with your most strength,hold down the Elevator Sticker,then release it after the Air Plane reach a certain height.

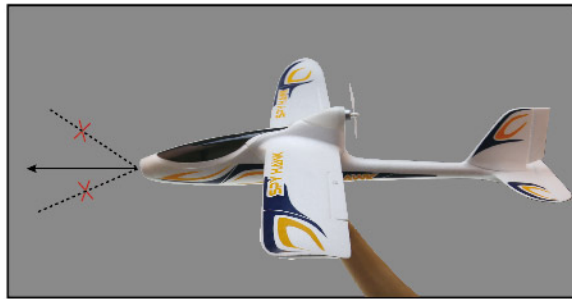

6.4 RTH function

When the GPS signal is good and the controller had the record of the position when the plane take off, the plane will enter into the RTH Mode after the signal lost or the battery voltage is low. The plane will hold the altitude and return to the take off position. When the plane returned, it will exit the RTH Mode.

When the plane enter into RTH Mode, pull down the SA(Switch A), the plane will exit the RTH Mode.

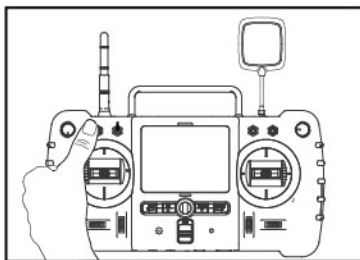

Push up the SA, the plane will enter RTH Mode

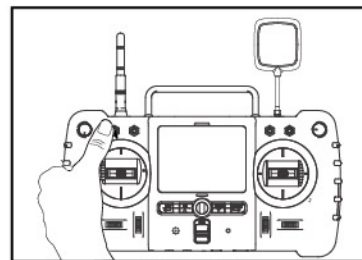

Pull down the SA, the plane will exit RTH Mode

6.5 Landing

Lower the throttle stick slowly to a quarter position, the plane will lose speed and slowly landing down.

5 5.8GHZ TECHNICAL TIPS

Keep the FPV 5.8Ghz antenna pointing as straight down as you can to give you a clear video picture and to avoid interference.

See Fig 1 above

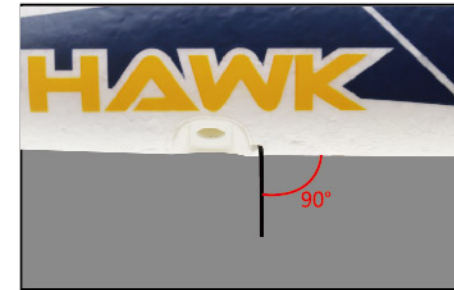
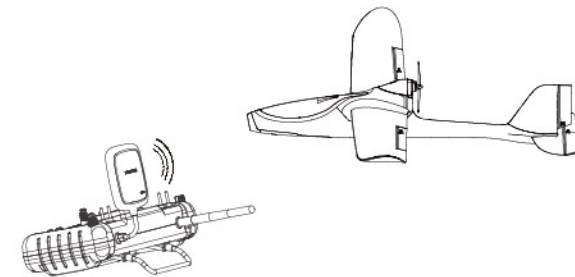

Fig 1

The live video distance is around 1000 meters. In order to gain the furthest communication distance, make sure the transmitter's antenna pointed vertically and no obstacles between it and the Air Plane when in flight.

Keep the antenna vertical and let the signal surface(the logo side) towards the Air Plane video signal antenna.

See Fig 2 above



Bend the transmitter antenna vertically, and keep the signal surface towards the Air Plane video signal antenna; Ensure there is no obstacles between the two, or the Air Plane will lose control.

Frequency selectable 5.8Ghz

The transmitter will automatically find the best frequency to ensure the quality live video transmission. in case there is any interference in your location, you can change the setting from the range 5725MHz~5865MHz to get longer range and better video transmission.

Hold down the ENTER key for 1 second to enter setting status, move the arrow to 5.8G FREQUENCY with up/down key, press the ENTER key again and select the frequency you need with up/down key, hold down the EXIT key for 2 seconds to confirm and exit.

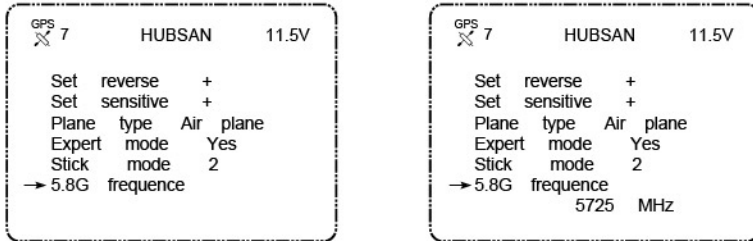

6.HOW TO LAUNCH

Make sure the plane installed correctly, the lipo battery is full charged and the transmitter loaded with 8 x AA batteries.

6.1 Bind the transmitter and the plane

Power on the transmitter, then the plane; the transmitter will show the lipo battery voltage and other values as below shows. If no value shows, need to bind the transmitter to the plane, hold down the ENTER button, power on the transmitter, wait the LCD screen shows "Bind to plane", then power on the plane.

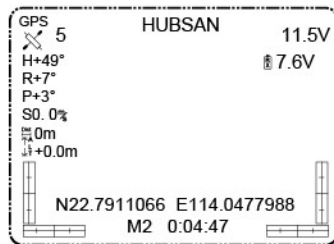

6.2 Check everything before flight

6.2.1 Check the plane's horizon level

Lay the plane on a level surface, see the value of Pitch(P) and Roll(R), the normal range should in 5° to -5°, if it is not in this range, the plane need to do level calibration.

Level calibration method:

Hold the Throttle stick to the full down position and move the Rudder stick to the lower right position. Quickly move the Aileron stick to the left and right repeatedly until the Red LED and Green LED lights on the Main Wing blinks two times, indicating successful calibration.

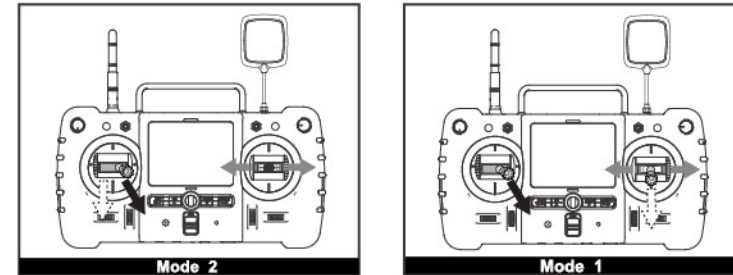

Check the rudder and the aileron servo, make sure they are in the lines with the Main Wing, adjust push rod if needed. All plane will be regulated in the proper position factory defaulted.

6.2.2 Check the Electronic compass

Hold the plane, keep it levelly, then spin the plane slowly to watch the Head(H) value, it will change from 0° to 360° continuously and evenly. When the plane point to Star North, the value will be 0°, or the compass need to do calibration.

Compass calibration method:

Hold the Rudder Stick in the down left, quickly move the Aileron Stick to the left and right until the Red LED and Green LED lights blinks alternately, indicating the the calibration is in process. In this moment, levelly spin the plane slowly for a 360°, and vertically spin the plane for a 360° to wait the LED stop blinking, indicating successful calibration.

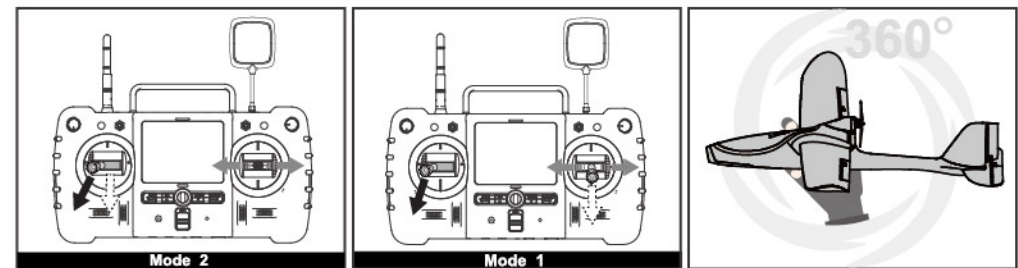

6.2.3 Check the GPS signal

Outdoors, after the plane power on for 2-5 minutes, the GPS value will be change into 6 or above 6, please wait until then to fly the plane.