



86" A-1 SKYRAIDER

35-60cc **WARBIRD**

Code : SEA 348SG

ASSEMBLY MANUAL

“Graphics and specifications may change without notice”.



Specifications:

Wing Span : Approx 86.5"

Length : Approx 67.3"

Wing Area : Approx 1055 square inches

Cowl Diameter : Approx 8-1/4"

Cowl Length : Approx 8" deep

Weight : Fully Equipped with All Rockets

Drop Tanks, Bomb, Pilot Figure, Smoke tank, Smoke pump 28.5 lbs-29.75 lbs

Engine : 35cc Gas-60cc Gas or Electric Equivalent

Radio 6-9 channels with 8-11 servos, 3 releases for drop tanks

ITEM CODE: SEA348

INTRODUCTION

Thank you for choosing the **LEGEND HOBBY 86" A-1 SKYRAIDER 35-60cc WARBLRD** ARTF manufactured by **SG MODELS**. The **86" A-1 SKYRAIDER 35-60cc WARBLRD** was designed with the intermediate/advanced sport flyer in mind. It is a semi scale airplane which is easy to fly and quick to assemble. The airframe is conventionally built using balsa, plywood to make it stronger than the average ARTF, yet the design allows the aeroplane to be kept light for its size. You will find that most of the work has been done for you already. The control surfaces have been pre-fitted with hinges are ready to be final glued into place. Flying the **LEGEND HOBBY 86" A-1 SKYRAIDER 35-60cc WARBLRD** is simply a joy.

This instruction manual is designed to help you build a great flying aircraft. Please read this manual throughly a few time before starting assembly of your **86" A-1 SKYRAIDER 35-60cc WARBLRD**. Use the parts listing below to indentify all parts.

WARNING !

Please be aware that this model aircraft is not a toy and if assembled or used incorrectly it is capable of causing injury to people or property. WHEN YOU FLY THIS AIRCRAFT YOU ASSUME ALL RISK & REPNOSIBILITY.

If you are inexperienced with basic R/C flight we strongly recommend you contact your R/C supplier and join your local R/C model Flying Club. R/C Model Flying Clubs offer a variety of training procedures designed to help the new pilot follow a more enjoyable and successful path to R/C flight. They will also be able to advise on any insurance and safety regulations that may apply.

LEGEND HOBBY 86" A-1 SKYRAIDER KIT CONTENTS

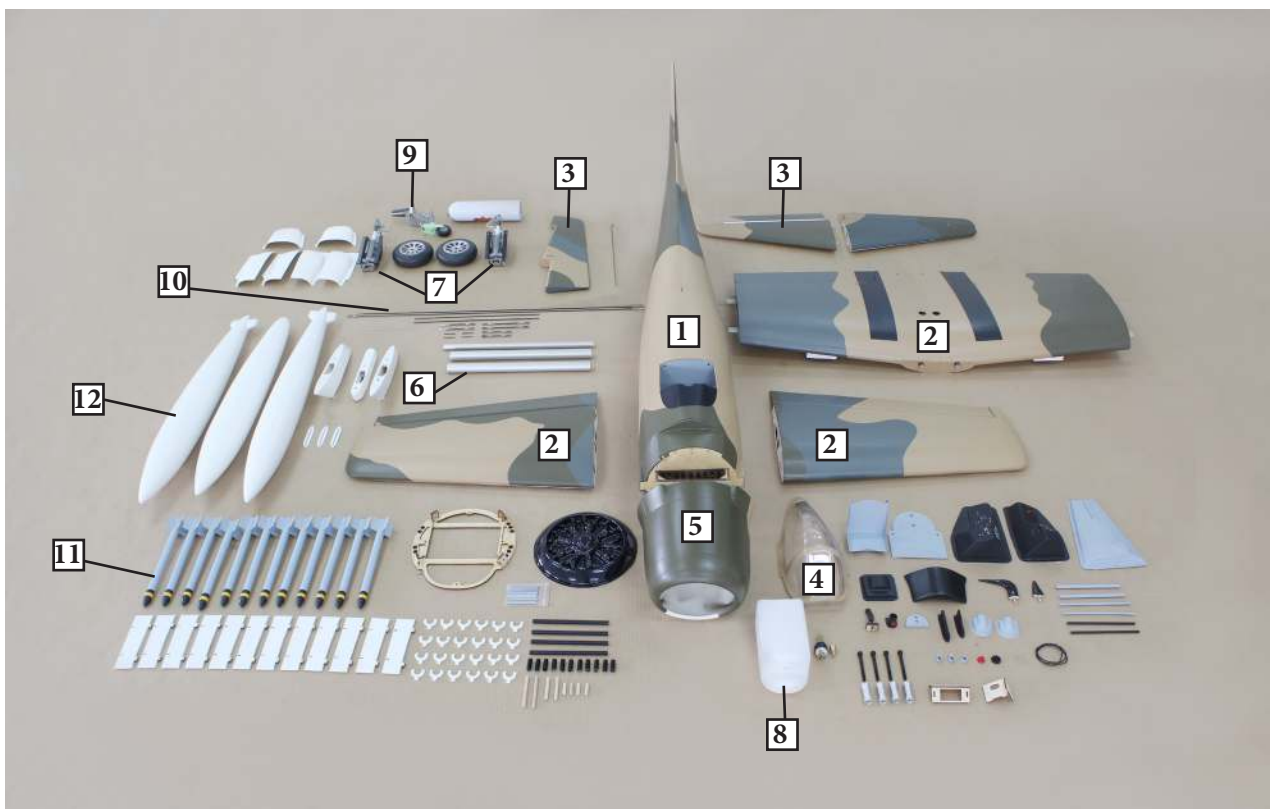

KIT CONTENTS

SEA348 86" A-1 SKYRAIDER 35-60cc WARBIRD

1. Fuselage
2. Wing set (3 pcs)
3. Tail set (2 pcs)
4. Canopy
5. Cowling
6. Wing tube
7. landing gear Optional/Not Included
8. Fuel tank
9. Tail Gear Optional/Not Included
10. Pushrod set
11. Rocket Set With Deluxe Model
12. Drop Tanks/Bomb W/Deluxe Model

ADDITIONAL ITEMS REQUIRED

- 35-60cc Engine or Electric Motor and ESC.
- Computer radio 6-9 channel with 8-11 servos.
- Spark plug to suit engine.
- Propeller to suit engine.
- Protective foam rubber for radio system.

TOOLS & SUPPLIES NEEDED

- Thin cyanoacrylate glue.
- Medium cyanoacrylate glue.
- 30 minute epoxy.
- 5 minute epoxy.
- Hand or electric drill.
- Assorted drill bits.
- Modelling knife.
- Straight edge ruler.
- 2mm ball driver.
- Phillips head screwdriver.
- 220 grit sandpaper.
- 90° square or builder's triangle.
- Wire cutters.
- Masking tape & T-pins.
- Thread-lock.
- Paper towels.

INSTALL THE AILERONS

Please see pictures below..

1.

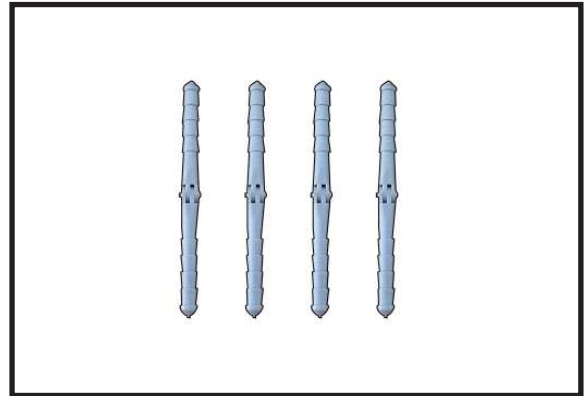

2.

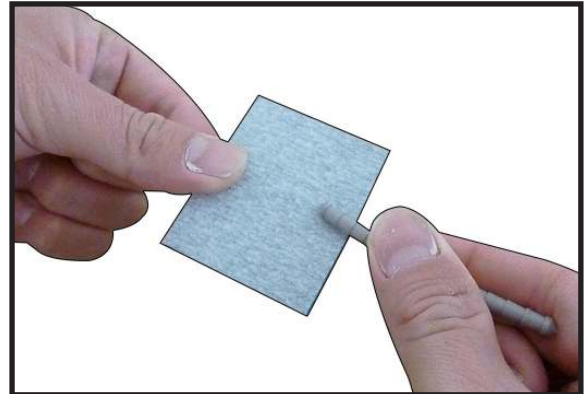

Remove the ailerons from the wing and remove the hinges.

Use a small piece of rough sandpaper to scuff the hinges for better epoxy adhesion. Do this to all aileron hinges.

3.

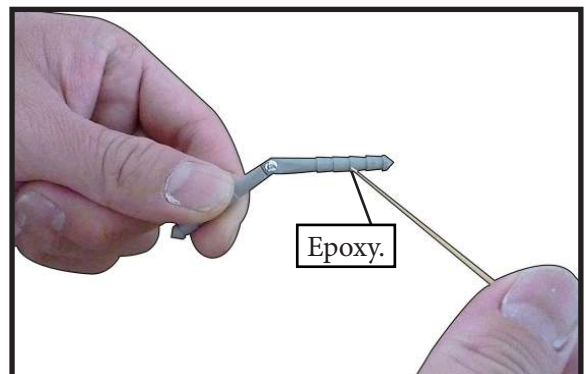

Apply epoxy to each hinge where it will be inserted into the ailerons. Tip: Apply some petroleum jelly to the metal pin hinge area to keep epoxy from interfering with smooth operation of hinge.

4.

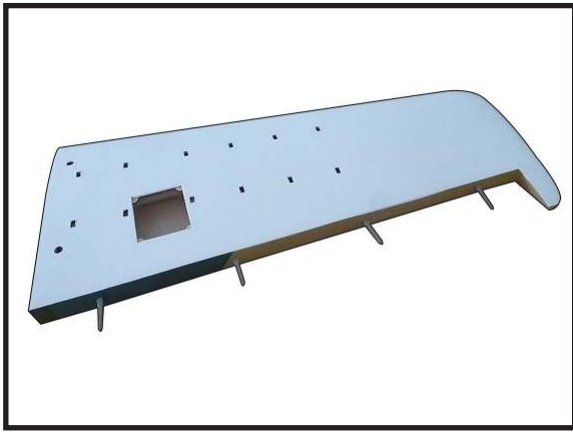

Insert all four hinges in the ailerons at this time. Make sure hinges move up and down in right direction and not side to side!

5.

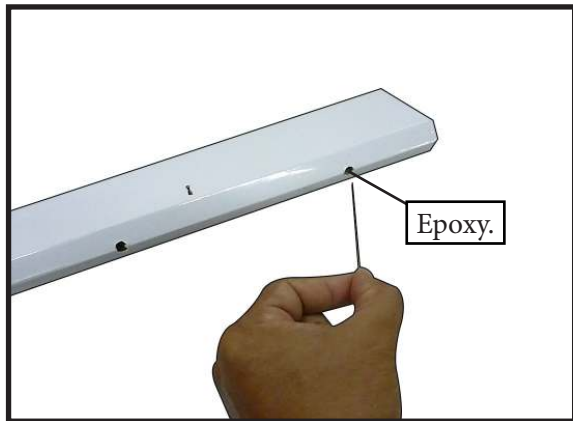

Apply epoxy into each of the holes in the ailerons using a spare piece of pushrod wire or toothpick.

Make sure to use enough epoxy so it securely adheres the hinge to the surfaces.

Do not use an excessive amount of epoxy when gluing the hinges so that it expels from the hinge area.

6.

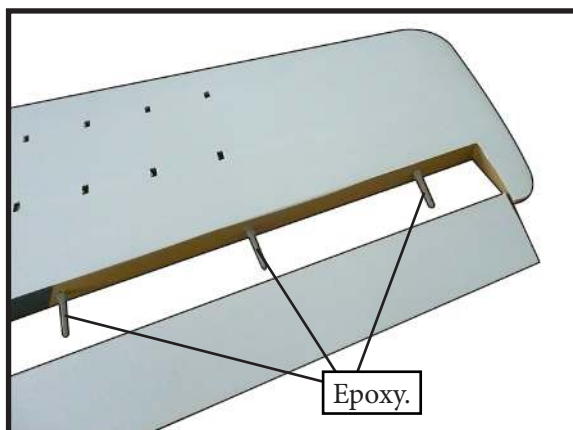

Be sure to test the aileron hinges once you insert them. Ensure that the hinge pockets line up, and that the hinges move freely before the epoxy dries.

7.



8.

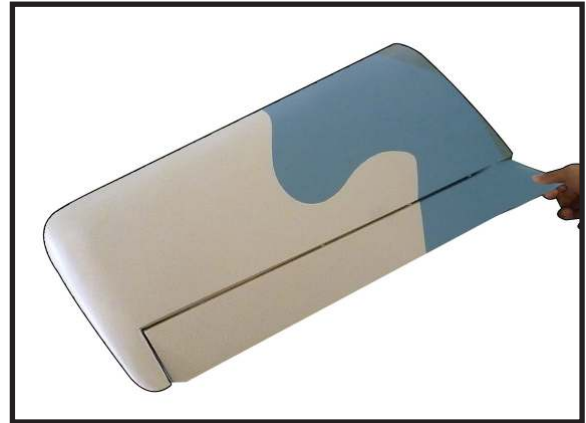

Check the fit of the aileron to the wing. The top of the ailerons will align to the top of the wing. Make sure movement is smooth and bind free.

We prefer 30-minute epoxy to allow enough working time during the hinge installation.

INSTALL THE AILERONS CONTROL HORN

1.

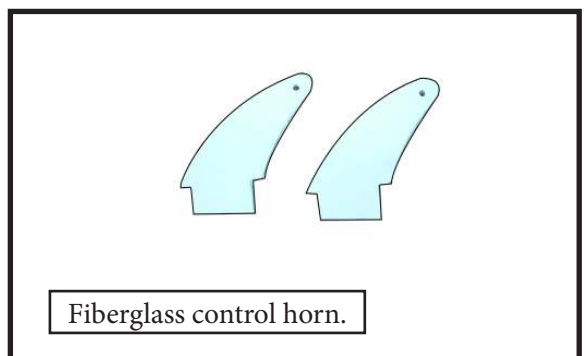

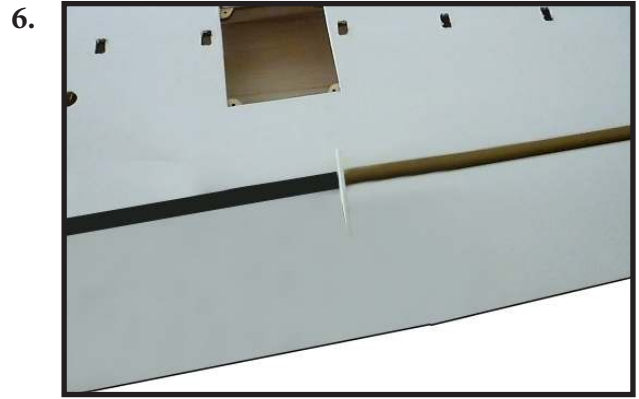
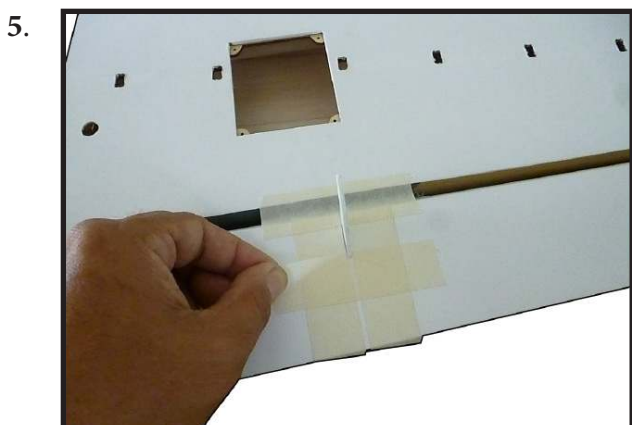
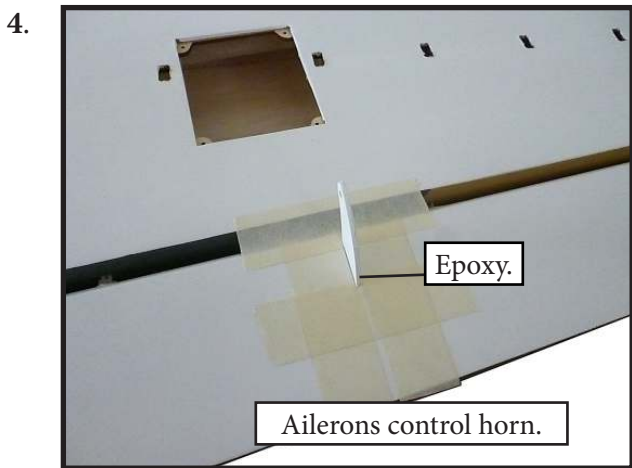
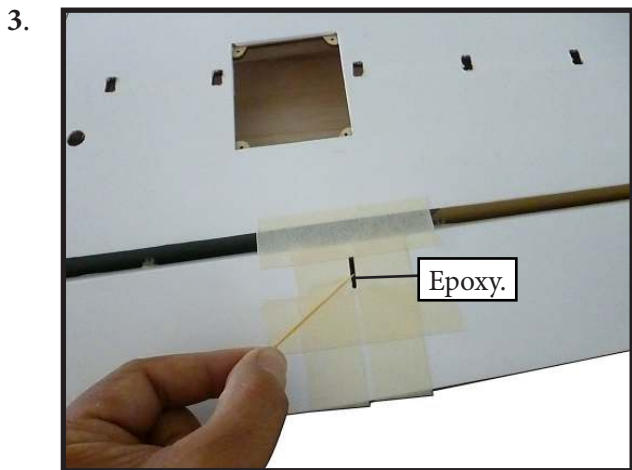
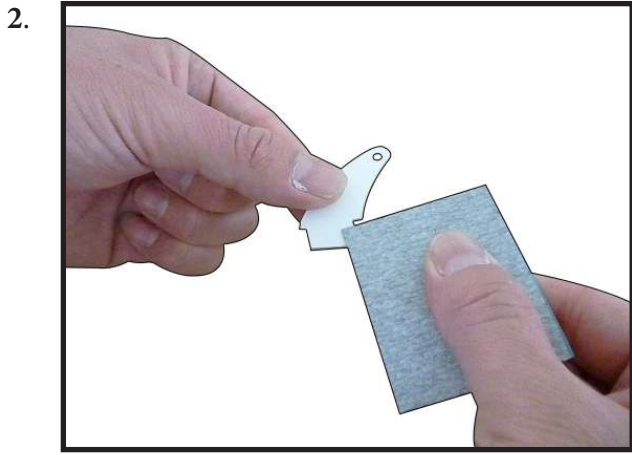

INSTALLING THE AILERON SERVOS

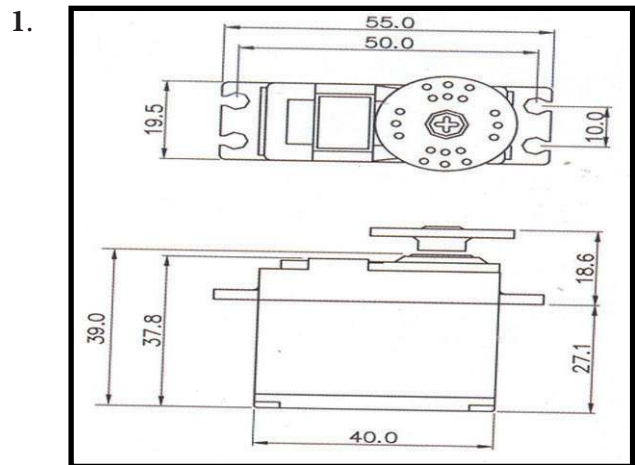

Recommended Servo Spec Torque.

106.93 oz-in (7.7 kg-cm) @ 4.8V
 133.31 oz-in (9.6 kg-cm) @ 6.0V

 Because the size of servos differ, you may need to adjust the size of the precut opening in the mount. The notch in the sides of the mount allow the servo lead to pass through.

Place the servo between the mounting blocks and space it from the hatch. Use a pencil to mark the mounting hole locations on the blocks.

2.

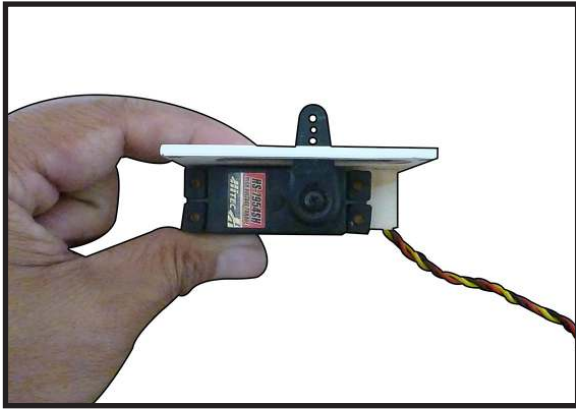

Use drill bit in a pin vise to drill the mounting holes in the blocks.

3.

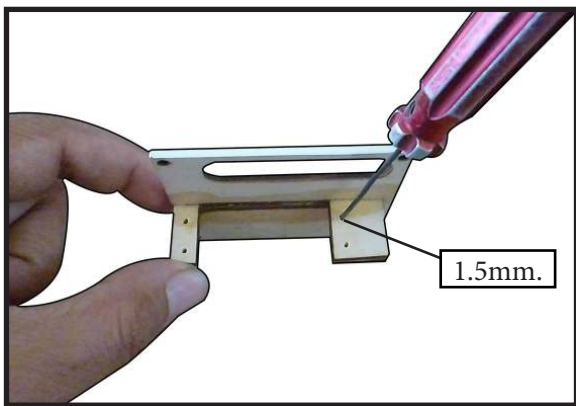

Apply 2-3 drops of thin C/A to each of the mounting holes. Allow the C/A to cure without using accelerator.

4.

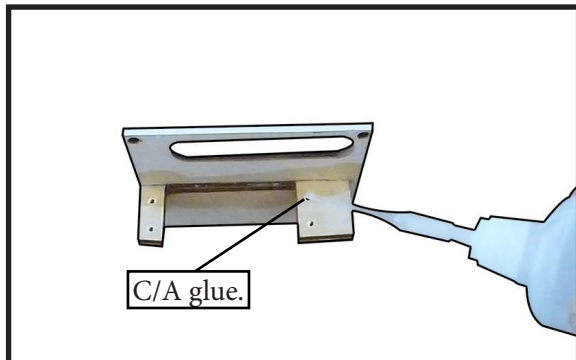

Use dental floss or heat shrink tubing to secure the connection between the servo and extension wire so they cannot become unplugged accidentally.

5.

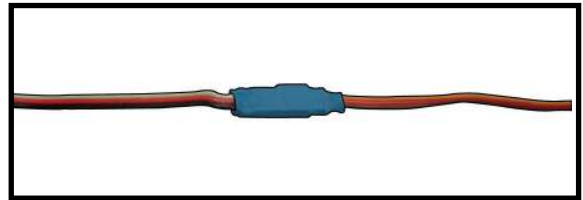

Secure the servo to the aileron hatch using a proper driver and the screws provided with the servo.

6.



Apply 2-3 drops of thin C/A to each of the mounting aileron hatch mounting tabs in the wing. ***Allow the C/A to cure without using accelerator.***

7.

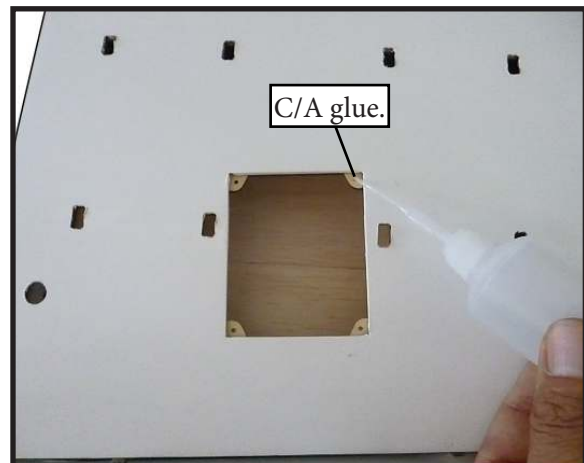

Remove the string from the wing at the servo location and use the tape to attach it to the servo extension lead. Pull the lead through the wing and remove the string.

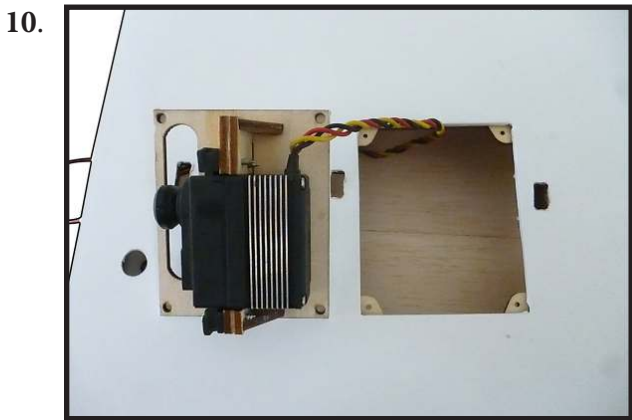
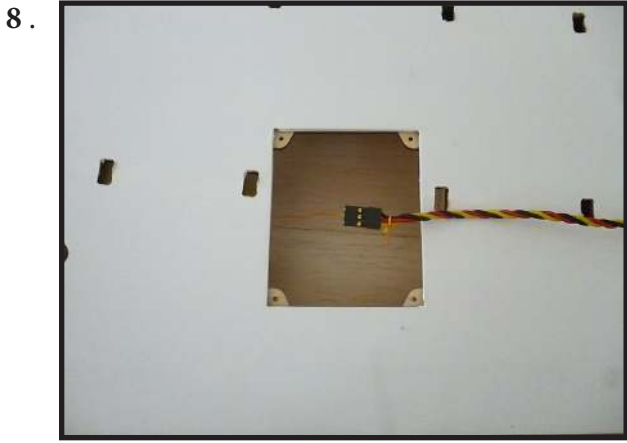

Set the aileron hatch in place and use a Phillips screw driver to install it with four wood screws.

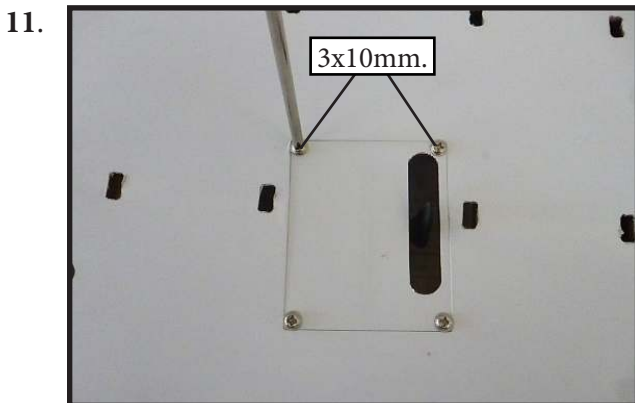

AILERON PUSHROD INSTALLATION

Please see pictures below.

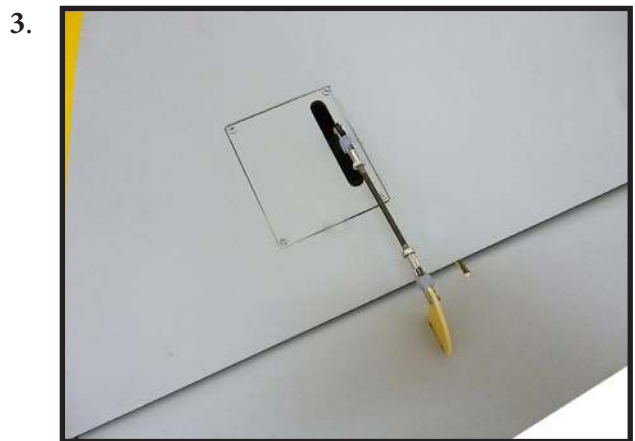
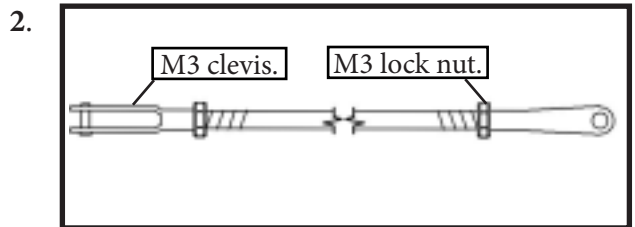
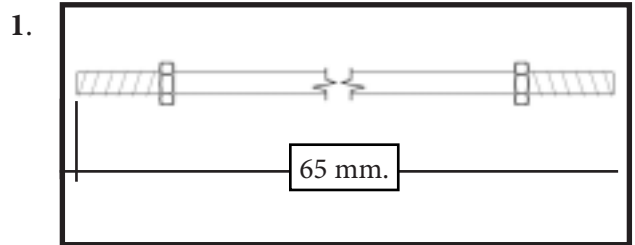

INSTALLING THE FLAP PUSHROD

Please see pictures below.

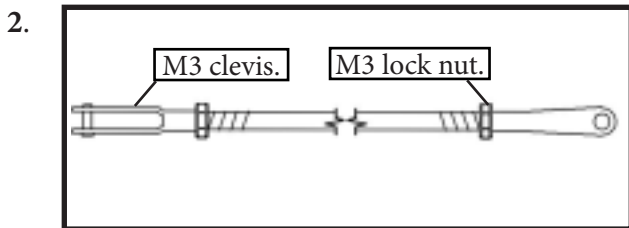
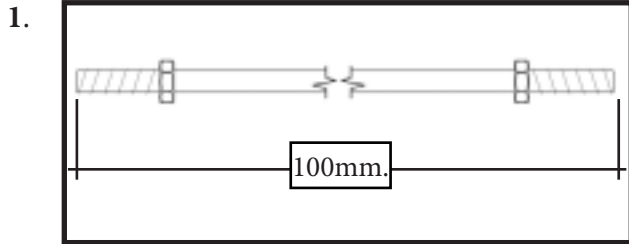

Attach the flap servo to the flap servo cover. Center the flap servo (or set the values to 0 for both up and down) and install the servo arm perpendicular to the servo centerline. The clevis will attach to the arm 13/16 inches (21mm) from the center of the arm.

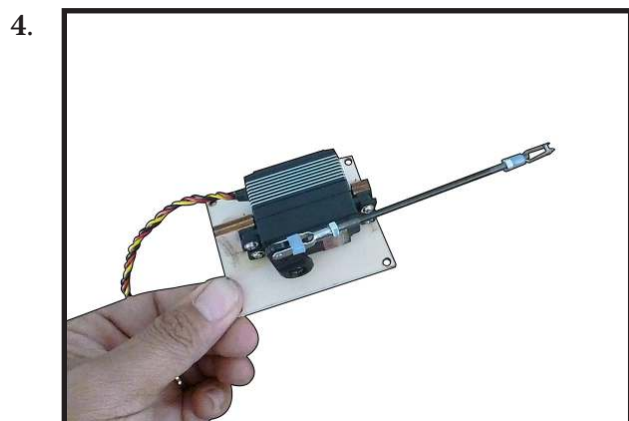
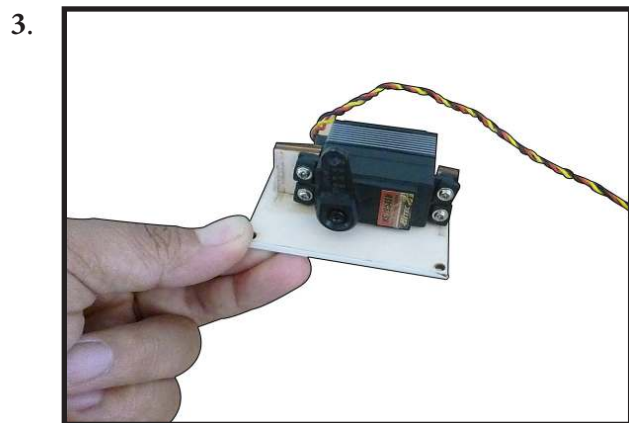

Attach the flap linkage to the control horn. Slide the clevis retainer over the forks of the clevis.

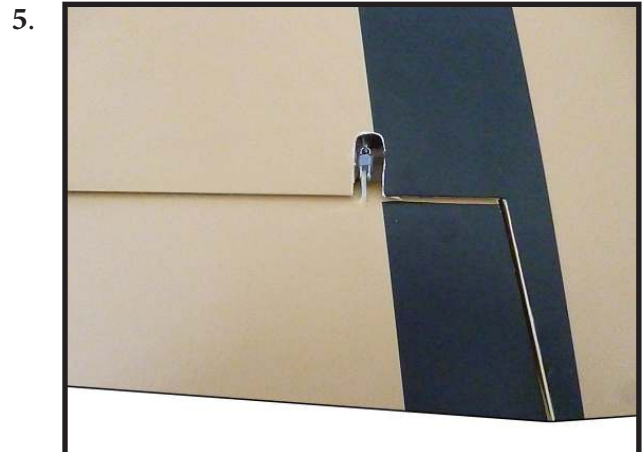

Attach the clevis to the flap servo arm.



Use a pin vise and 3/32-inch (2mm) drill bit to clear the paint from the flap control horn.



Route the servo lead for the flap servo out at the root of the wing. Connect the flap servo to the radio system. With the radio system on, place the flap servo into position.

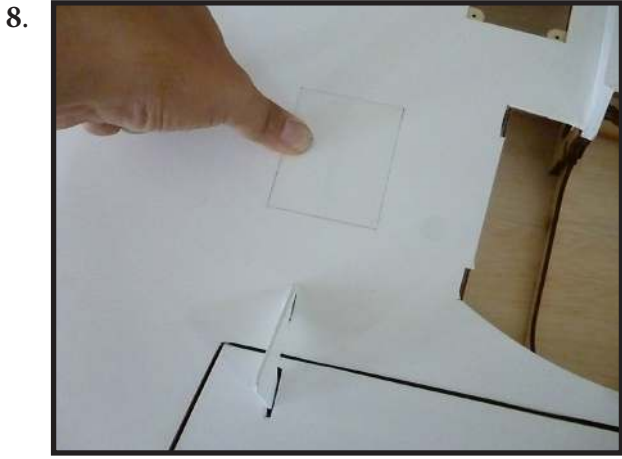

Adjust the linkage so the flap is in the mid-flap position. It may take a few tries to properly adjust the linkage.

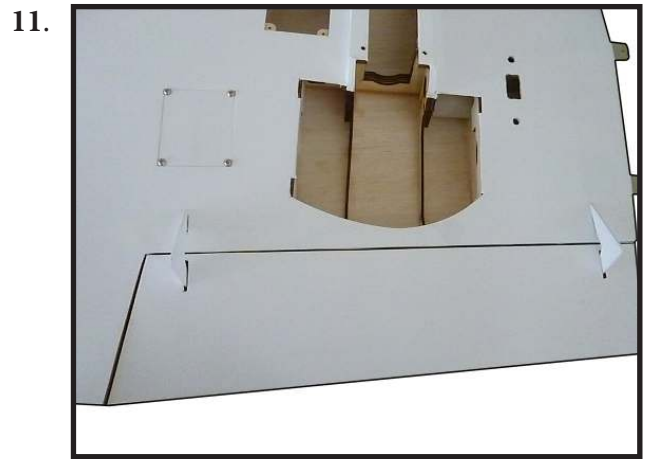

Set the flap control at the transmitter to the down flap position. Adjust the flap travel at the transmitter until it matches the control throws listed in this manual.

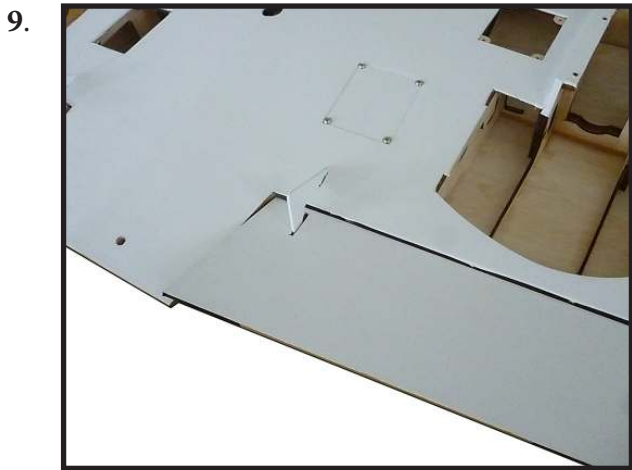

Once adjusted, make sure all clevis retainers are in position. Apply a drop of threadlock near the clevis, then tighten the nut against the clevis to keep the linkage from changing length inside the wing.

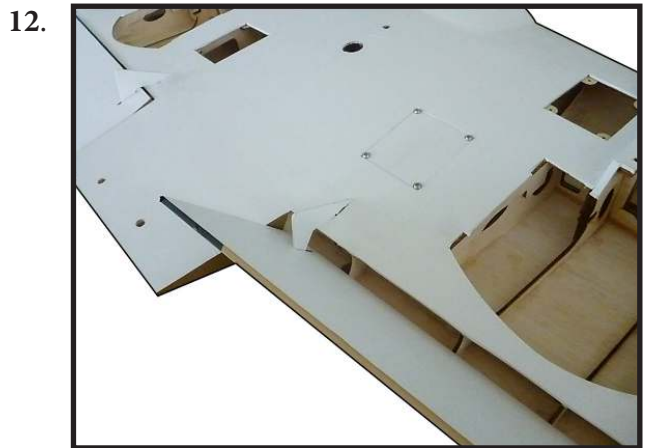

Trim the flap linkage cover using a hobby knife, hobby scissors and some fine sandpaper as needed.

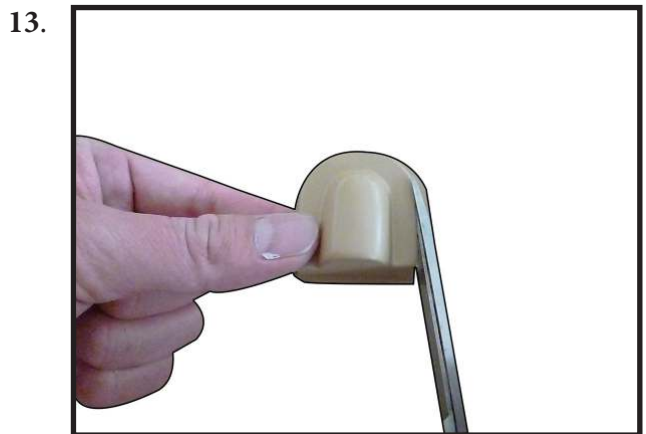
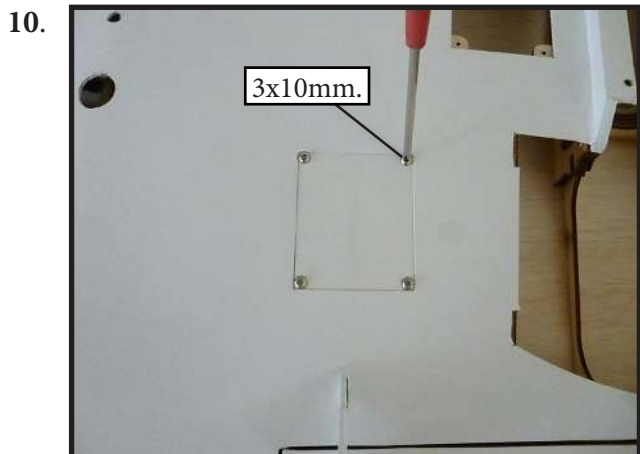

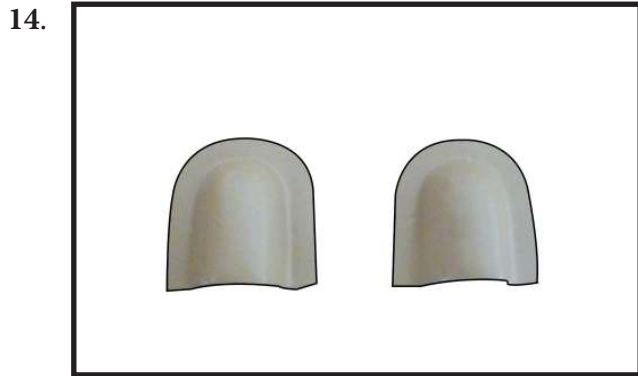

Fit the flap linkage cover into position. Check the operation of the flap to make sure the cover does not interfere with the flap linkage.



Use canopy glue to attach the cover to the wing. Use low-tack tape to keep the cover in position until the adhesive fully cures. Blue painters tape works well !

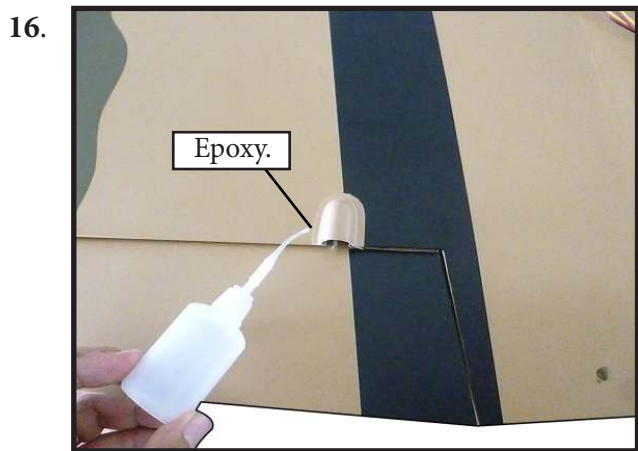

WING ASSEMBLY

Please study images below.

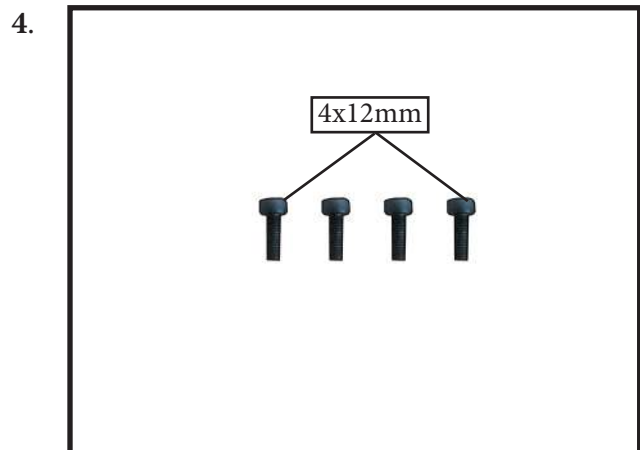
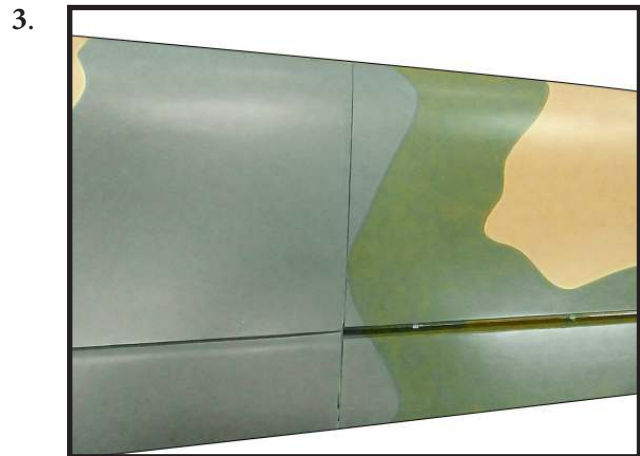
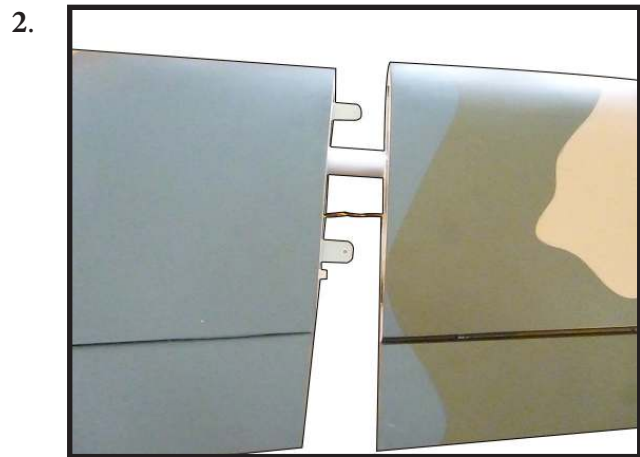
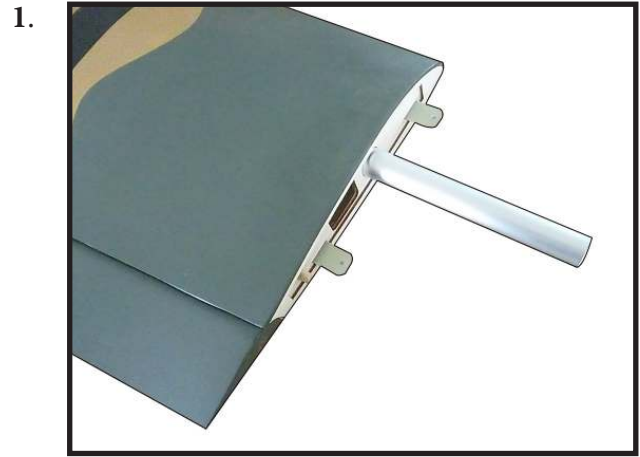

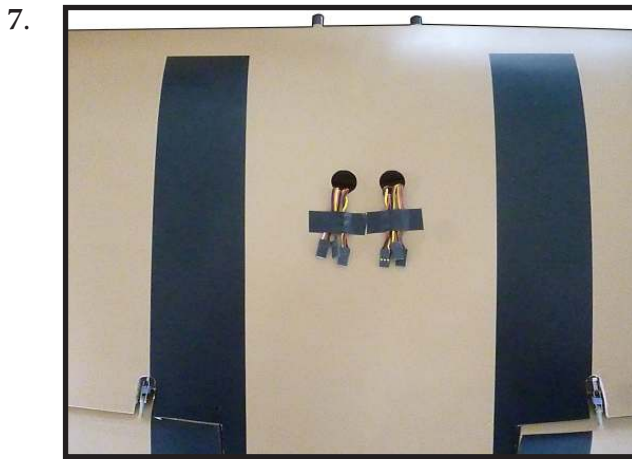
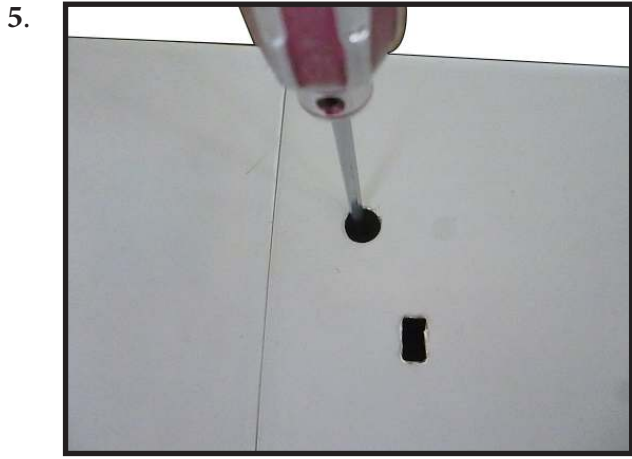

INSTALLING LANDING GEAR

Retractable landing gear are not included. Please study images below for proper installation. You may install electric or pneumatic gear. Fuselage has accommodations for both.

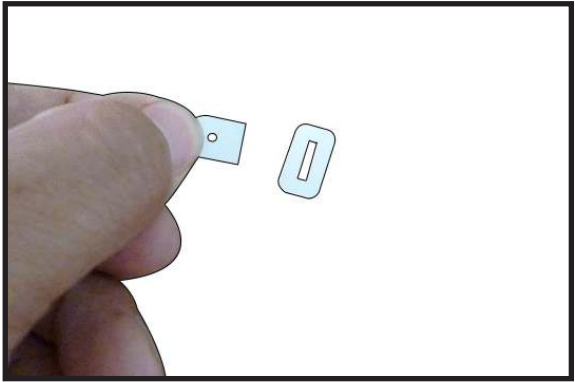
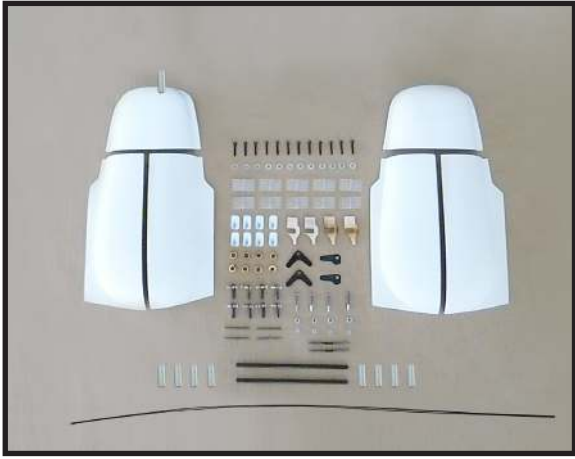

Insert gear door control horn tab into hole.

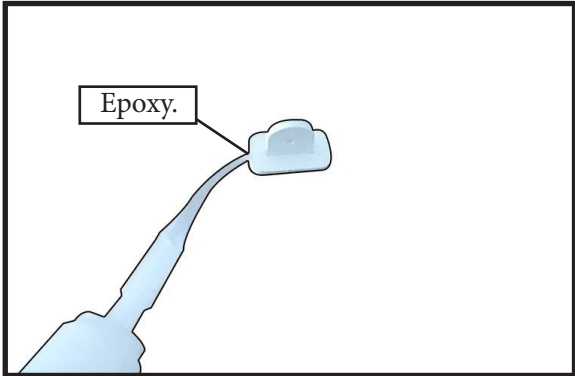

Apply epoxy glue to parts.

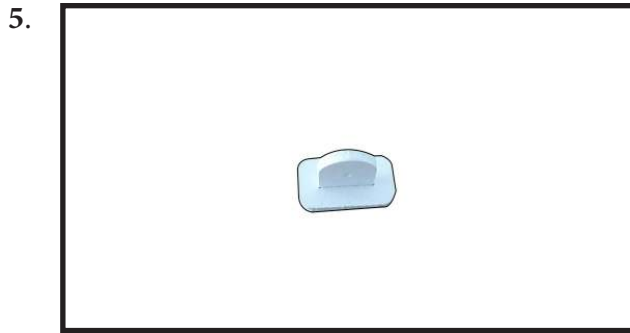

Allow part to completely dry. Once dried completely you may proceed to next step.



Trim part to match image.

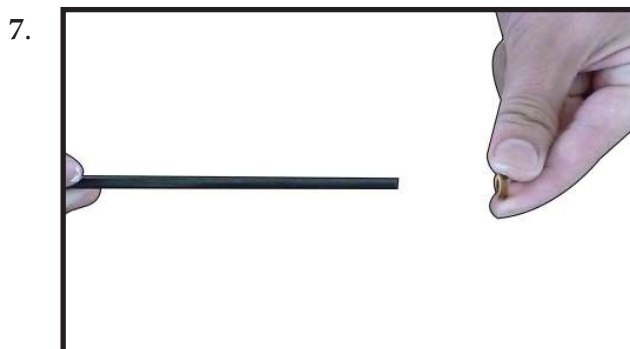

Put one wood ring on each end of the carbon rod.

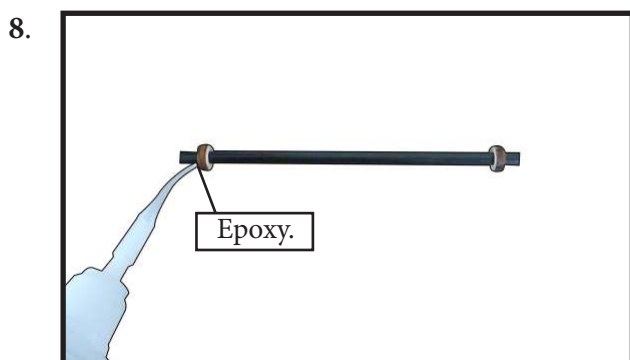

Make sure you space the wood ring so that the bellcrank and another wood ring will fit on each of the carbon rods. Then epoxy into position.



Study images below. Then place a bellcrank on each end of carbon rod as shown.

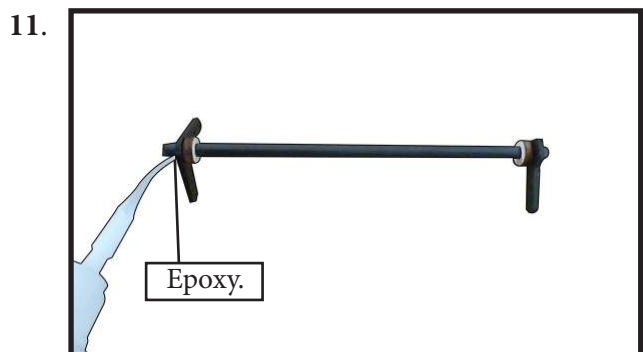

Epoxy glue parts into place.



The finished assembly should look like this.

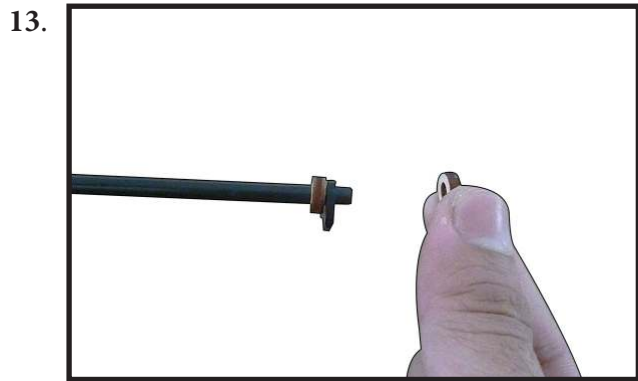

Please change eps to steps.

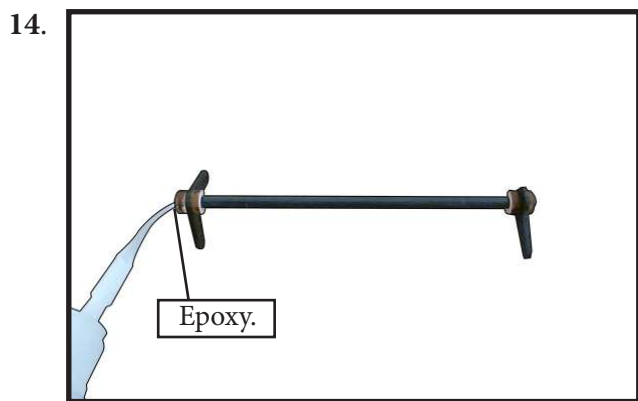

Epoxy glue parts together.

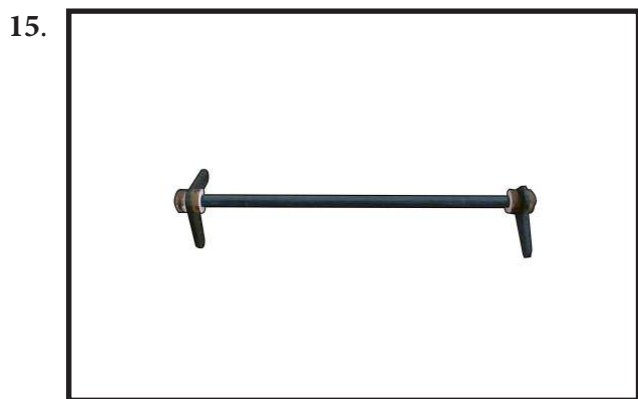

Completed Assembly.

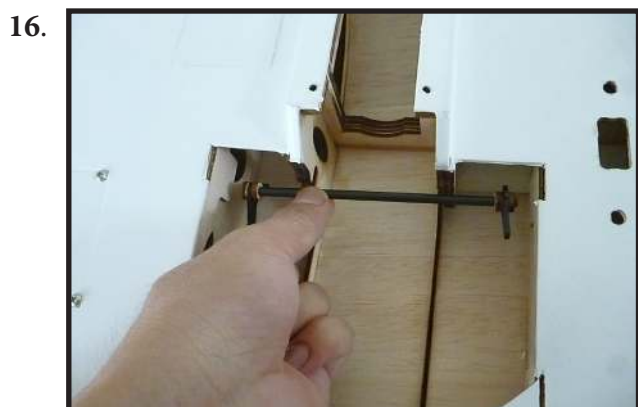

Place the actuation rod into the wing.

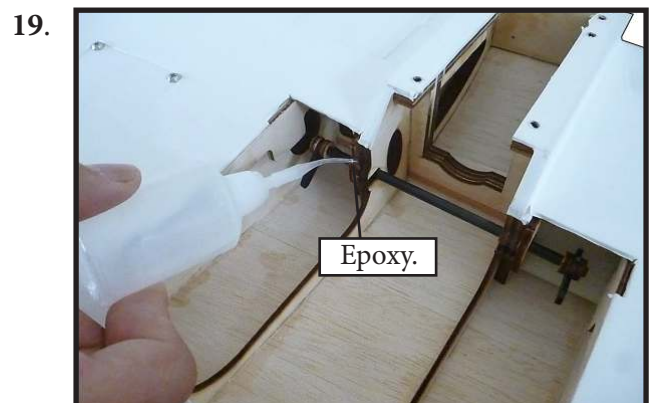
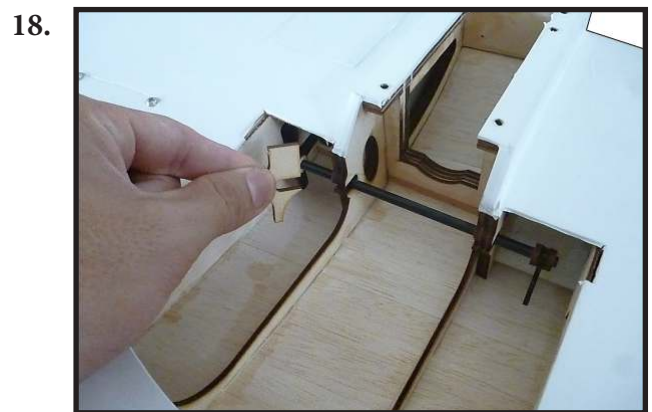

Put wooden bearing parts in the wing and CA or epoxy into place. Make sure not to glue the actuation rod.



Finished actuation rod installation.

Install the gear door servo into the wing cover as shown below in these illustrated steps.

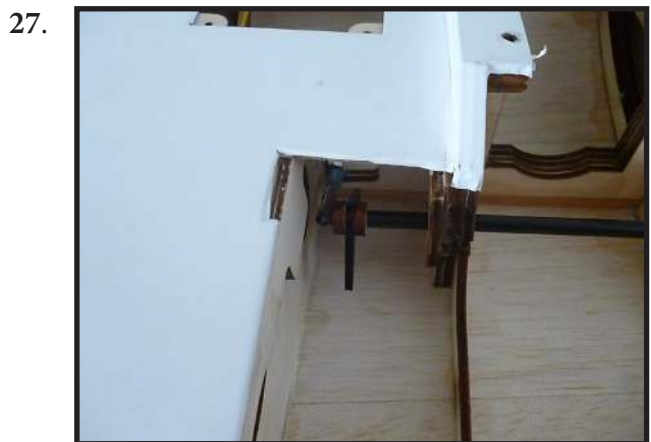
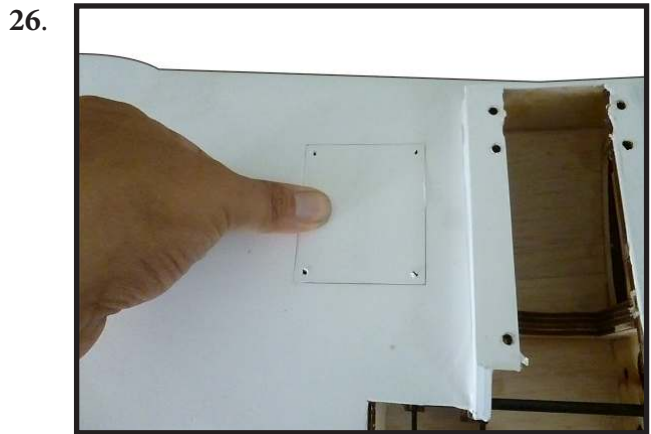
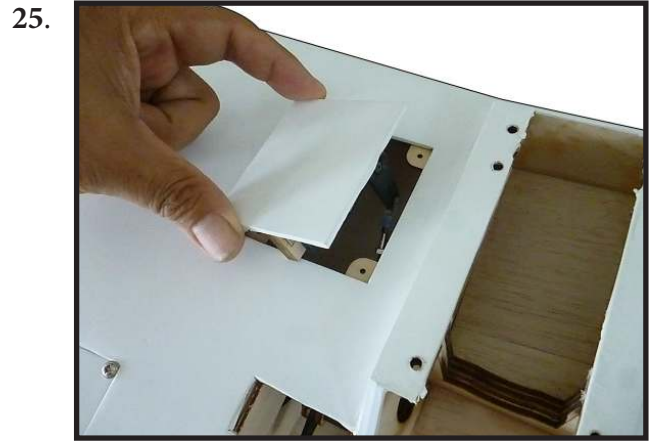
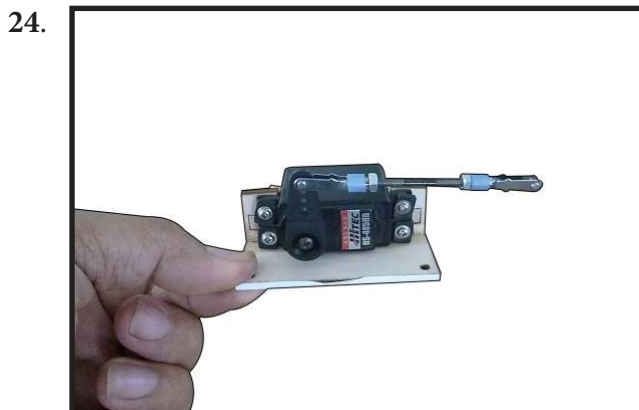
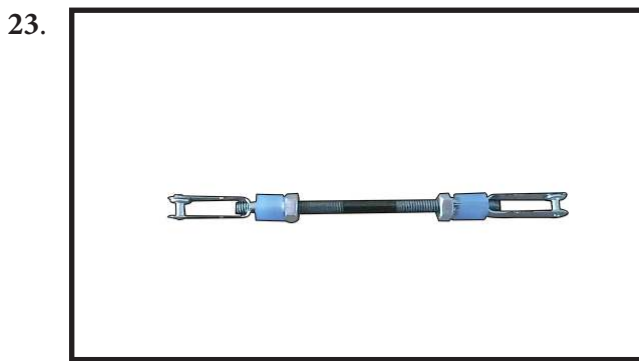
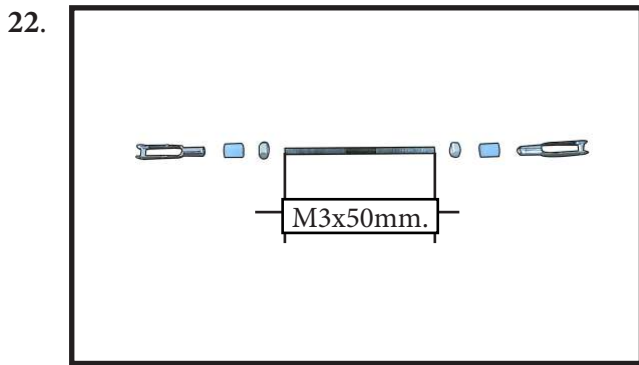
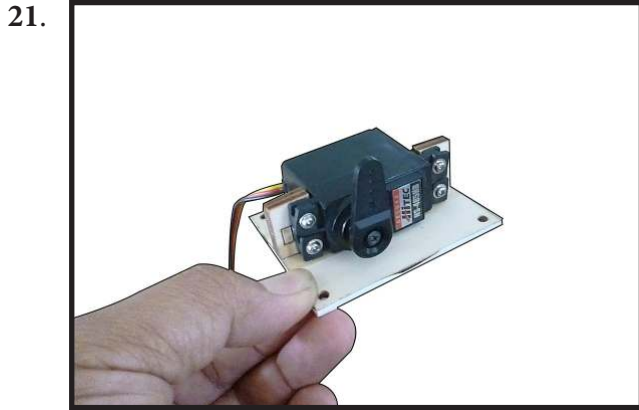

Finished gear door servo/control rod.

Install Main Retractable Landing Gear.

29.

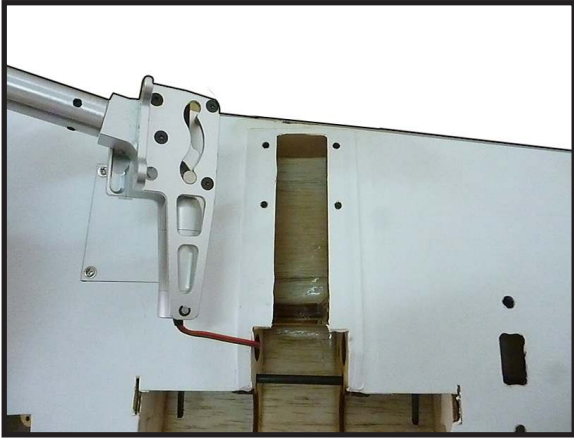

30.

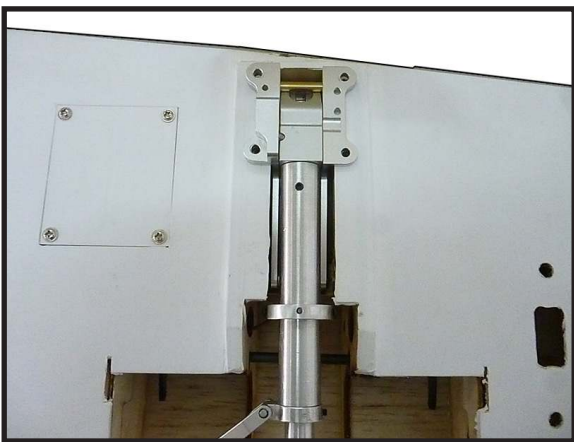

31.

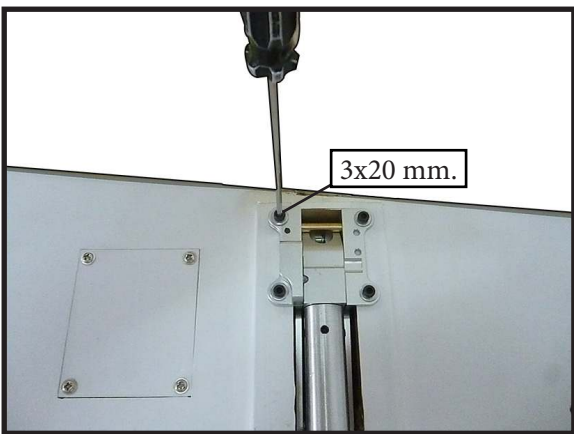

32.



Attach hinge to front gear fairing and wing.

33.

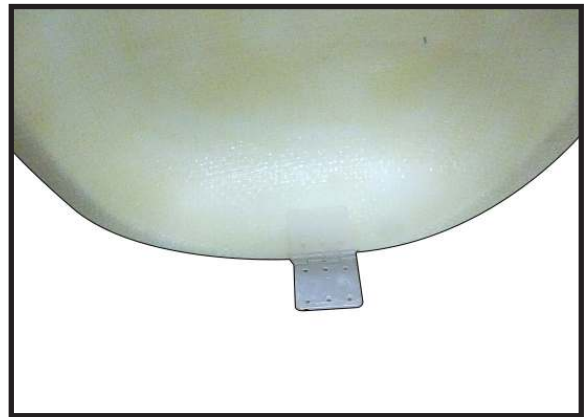

34.

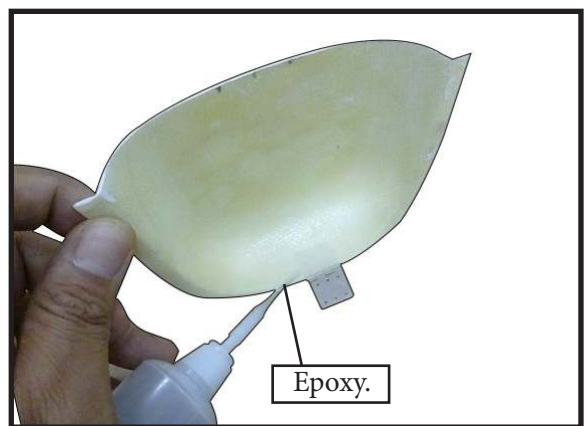

35.



36.

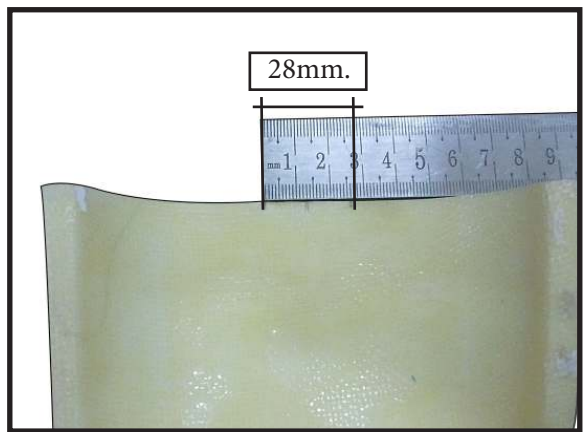

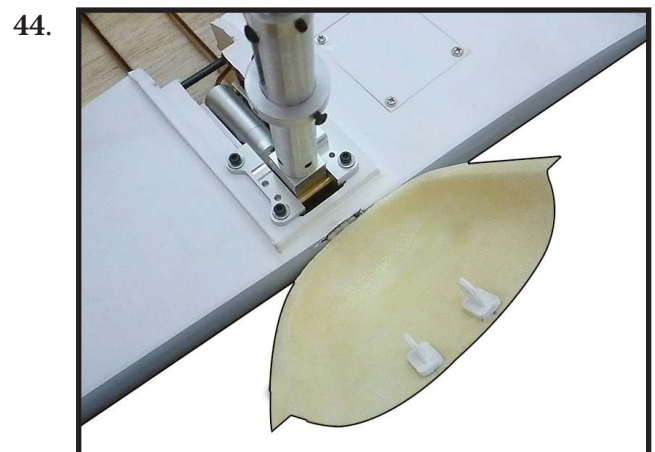
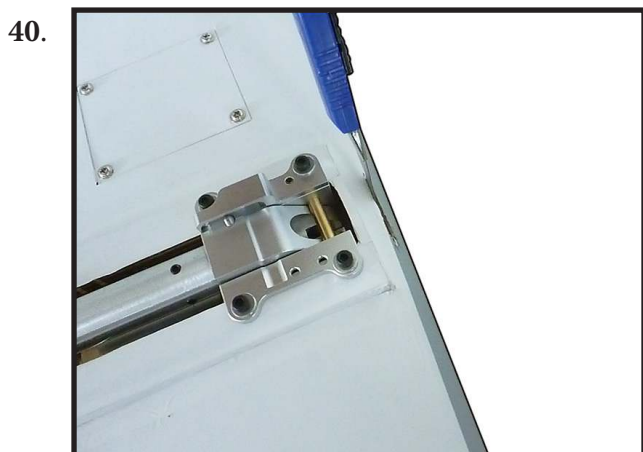
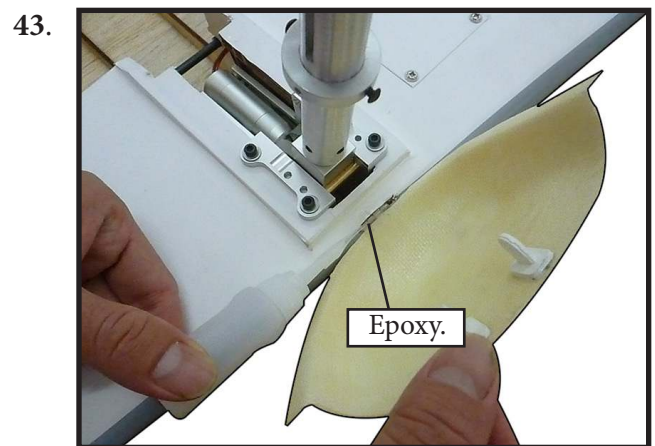
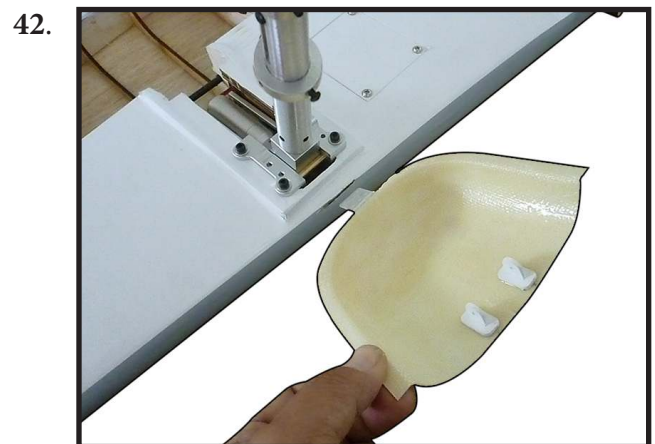
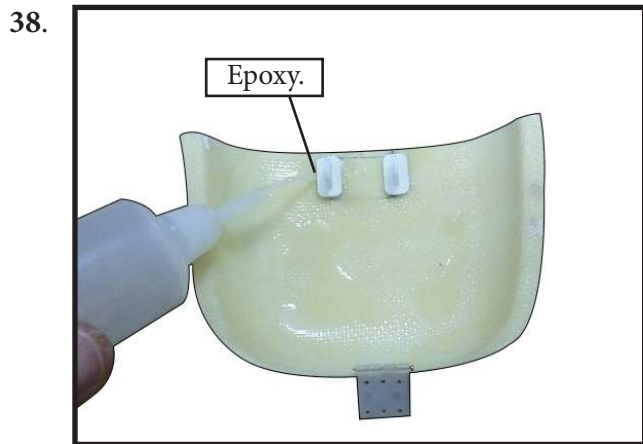
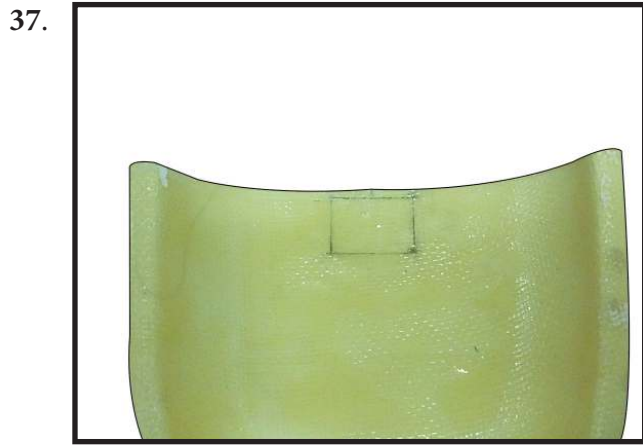

Install the cable to the cover and wing.

45.

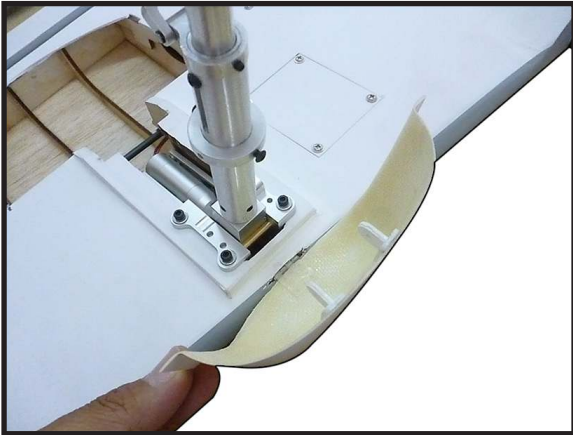

46.

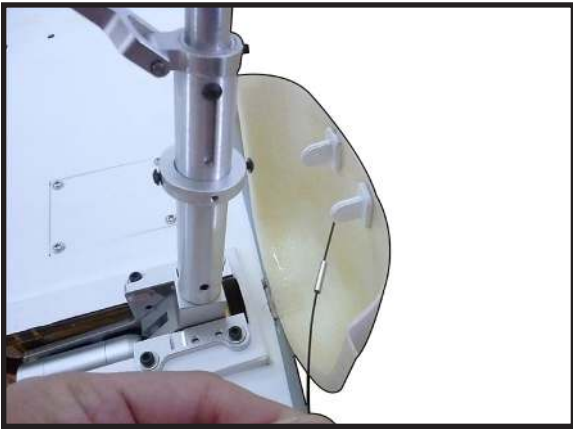

47.

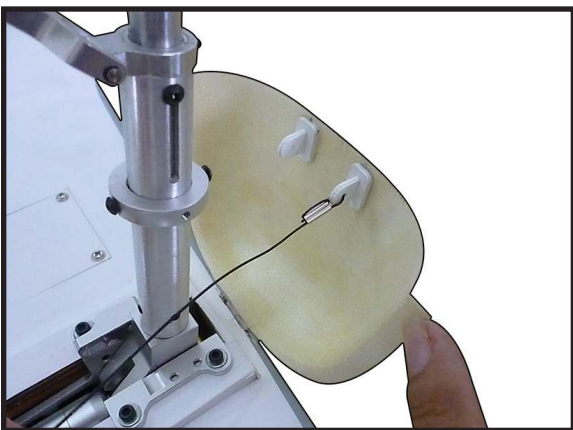

48.



49.

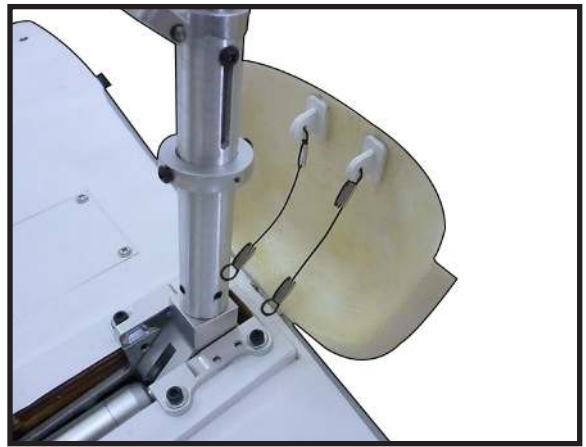

50.

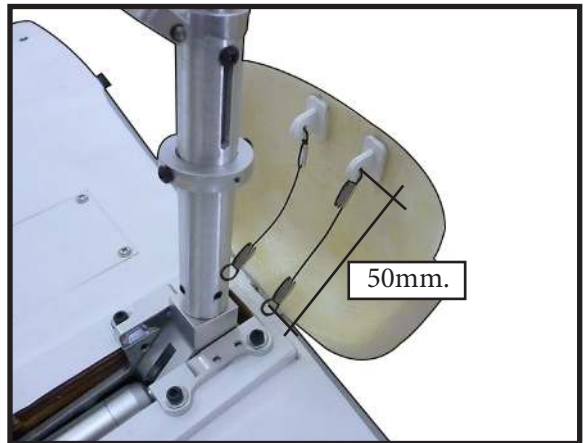

51.

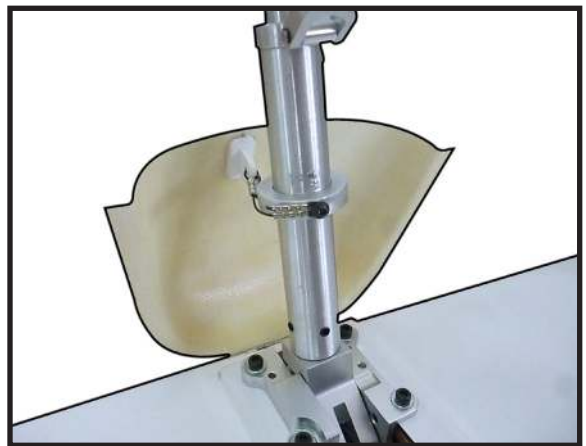

52.

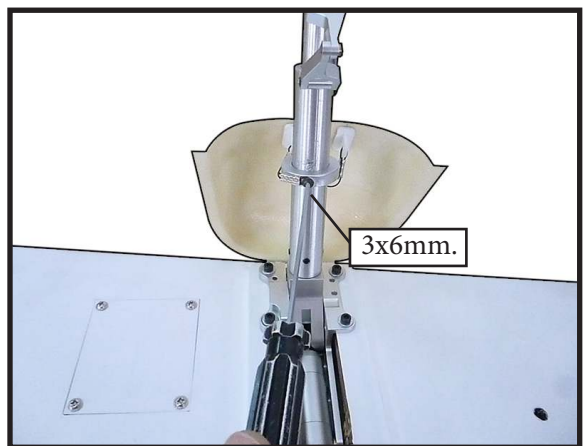

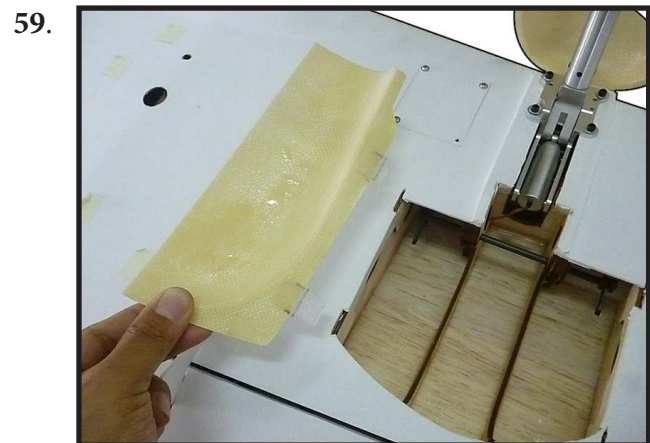
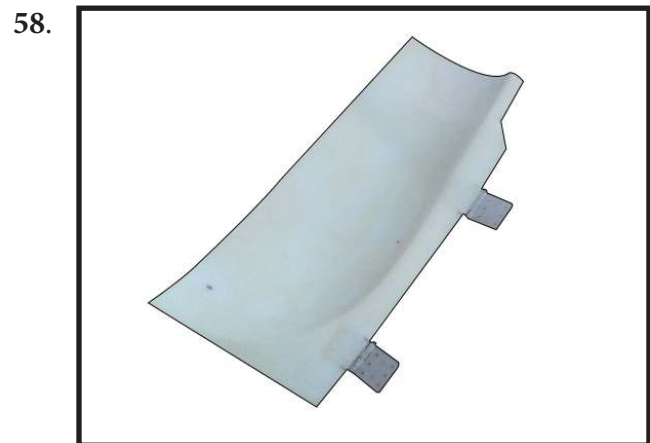
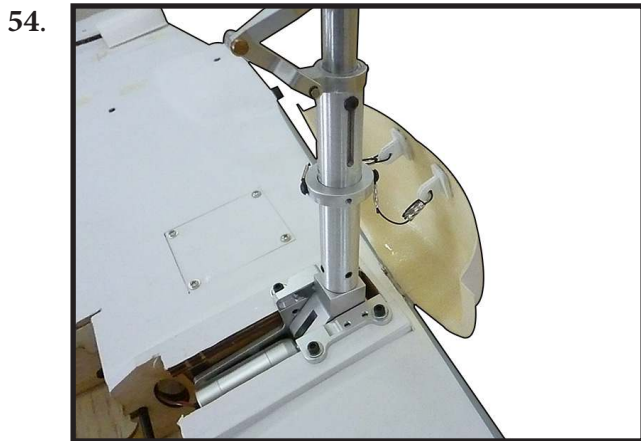
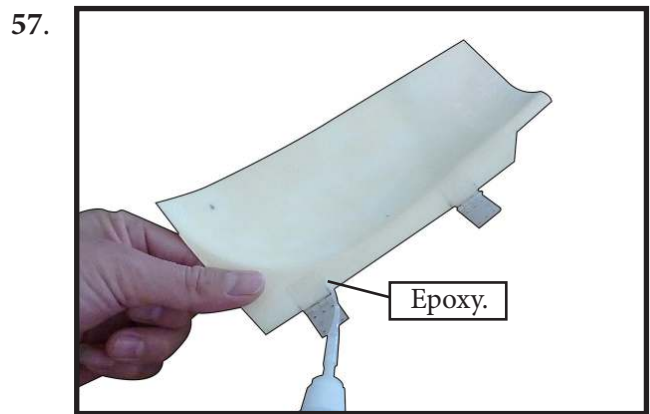

Continue Attaching the hinge to the cover and wing.

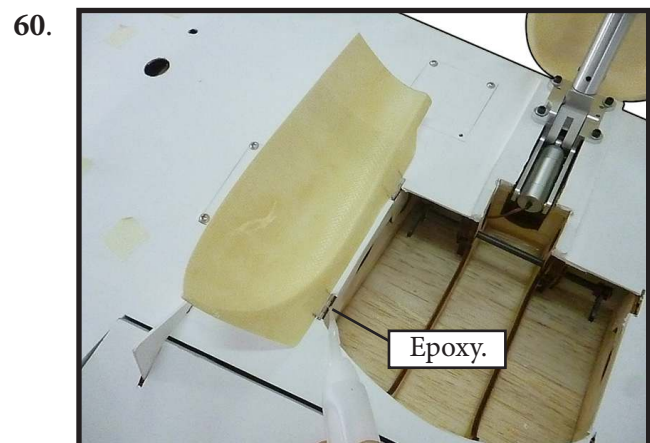
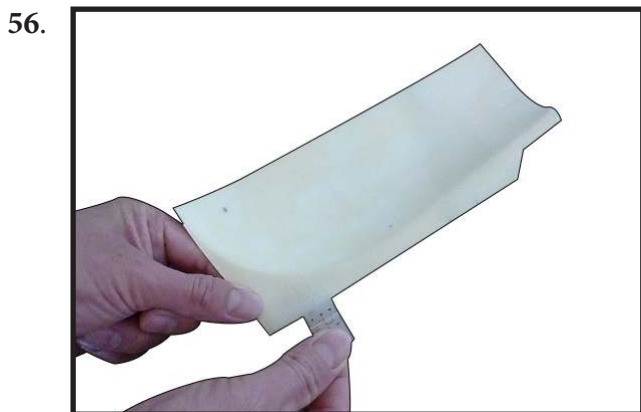

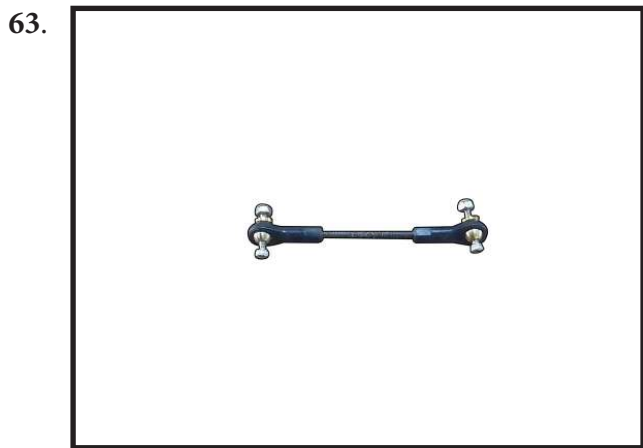
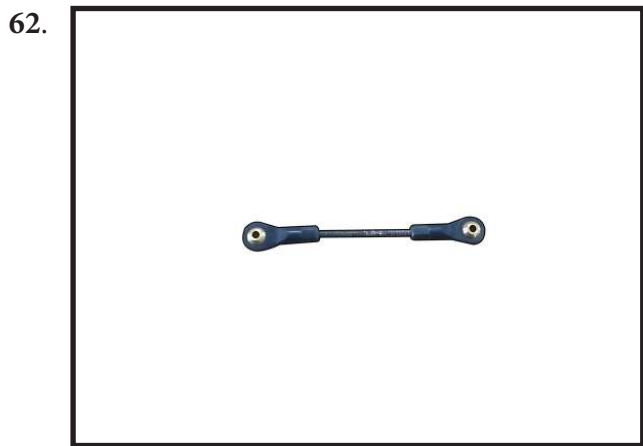
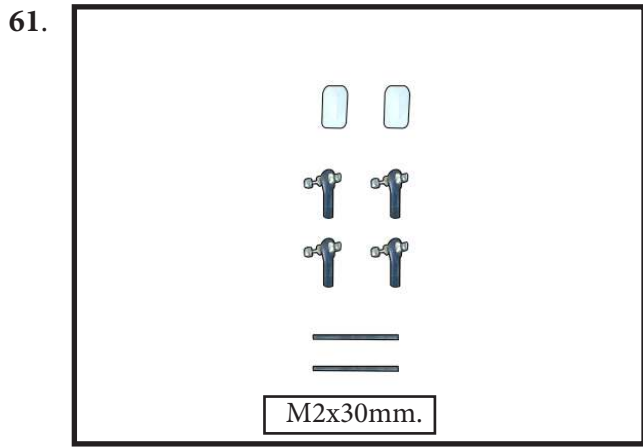

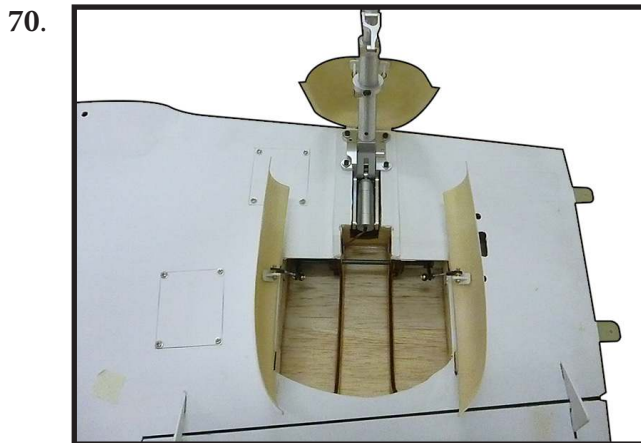
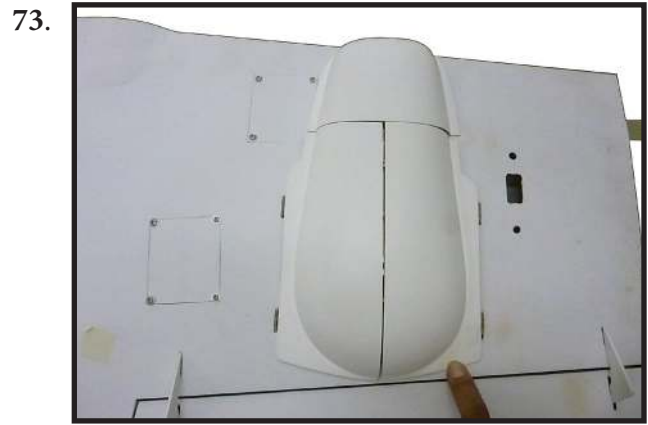
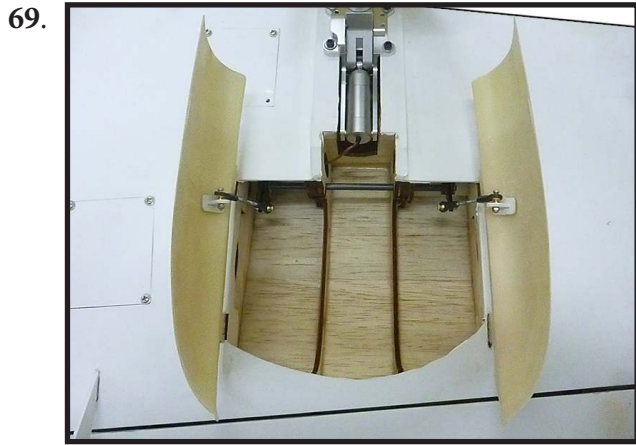

ROCKETS INSTALLATION

Please study images below.

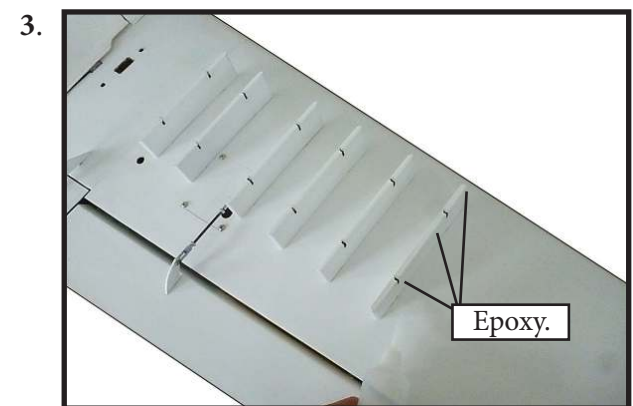
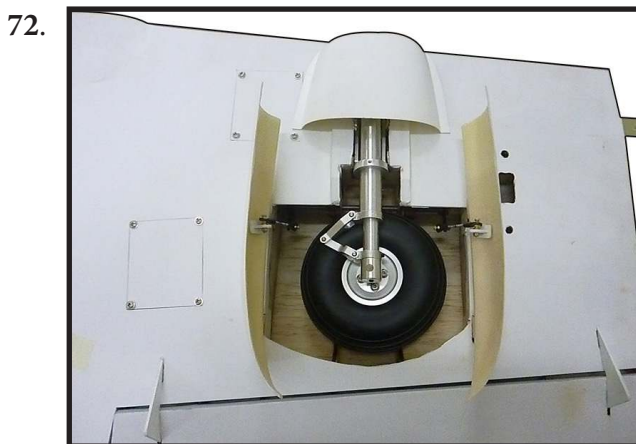
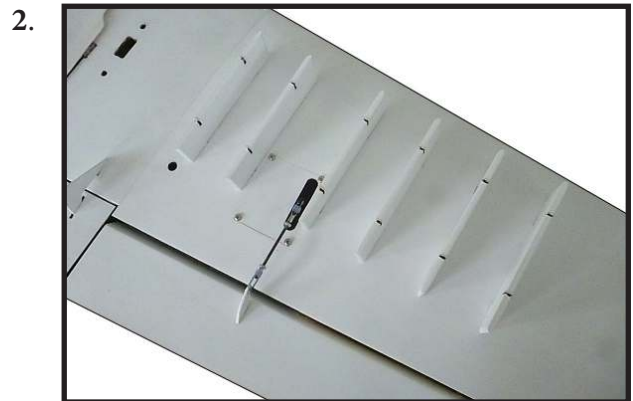
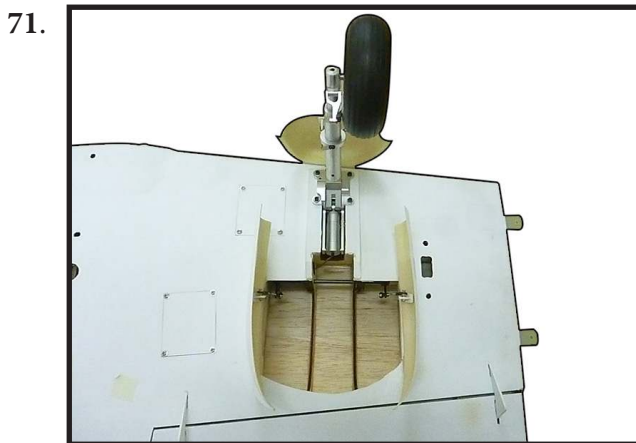
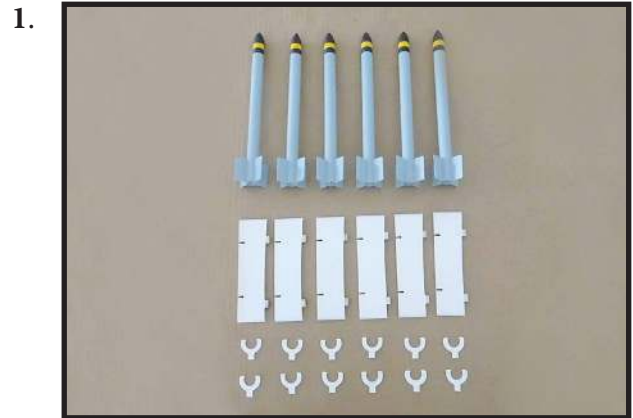

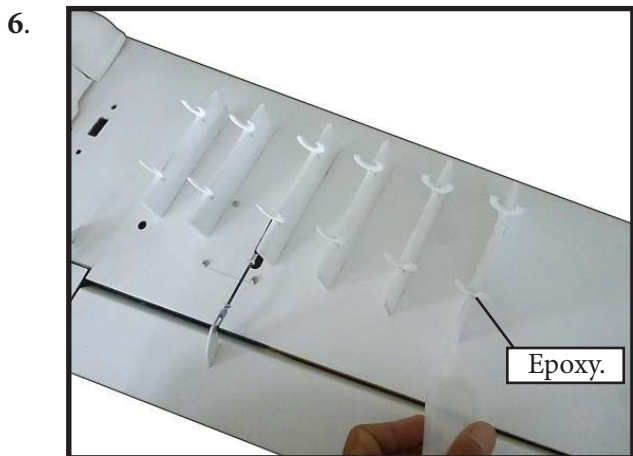
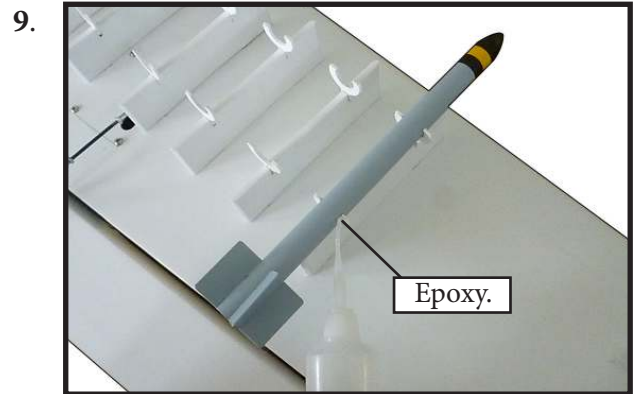
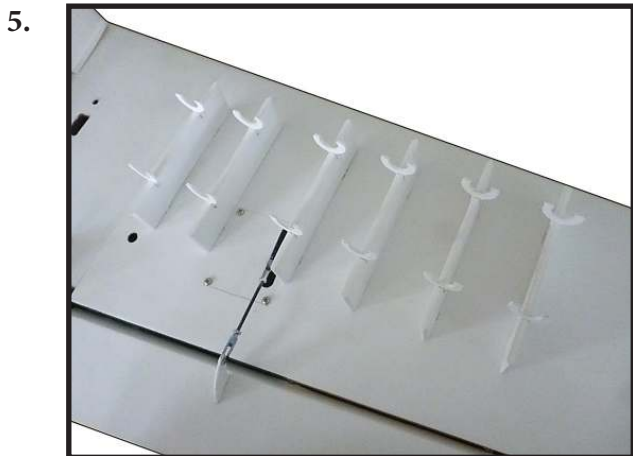
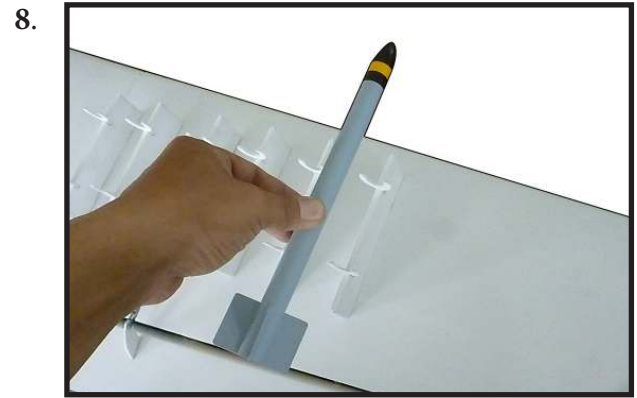
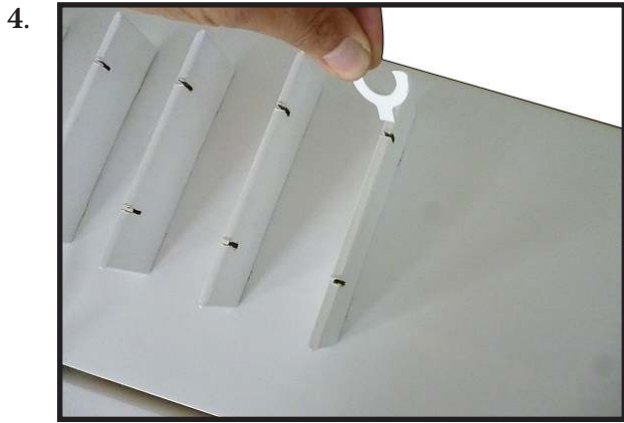

DROP TANK/BOMB INSTALLATION

Please study images below.

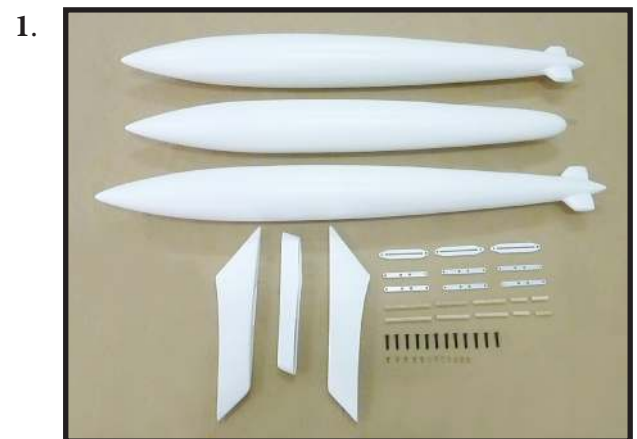
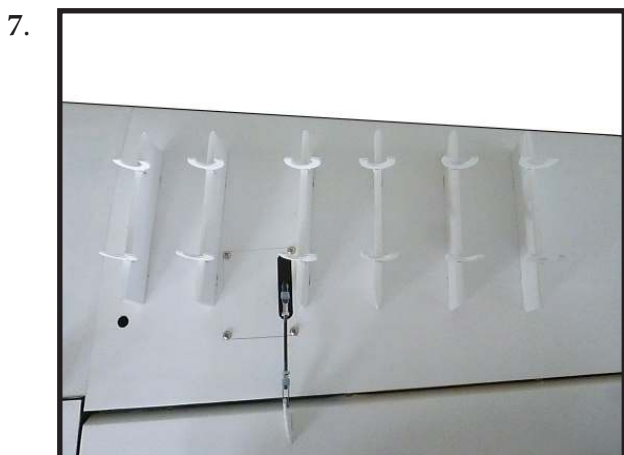

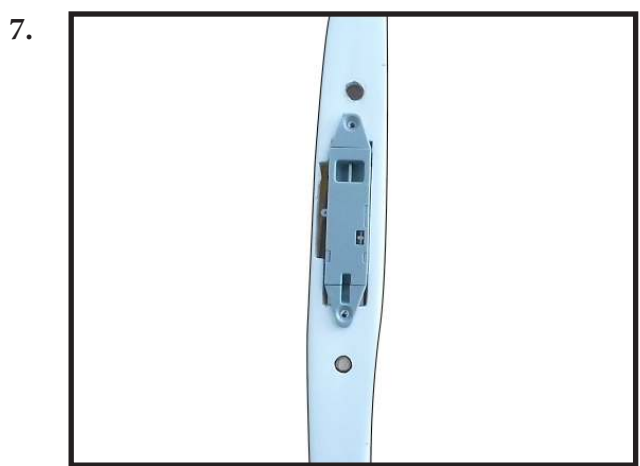
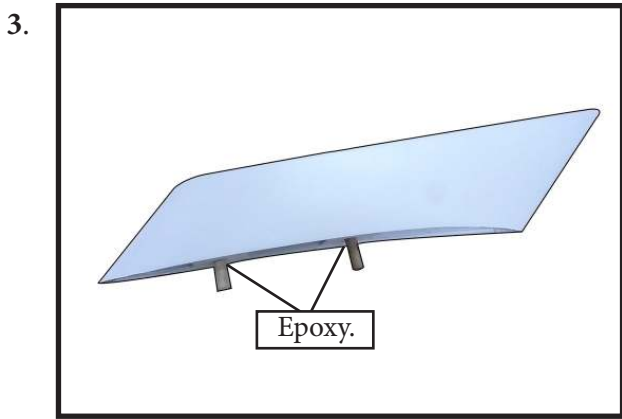
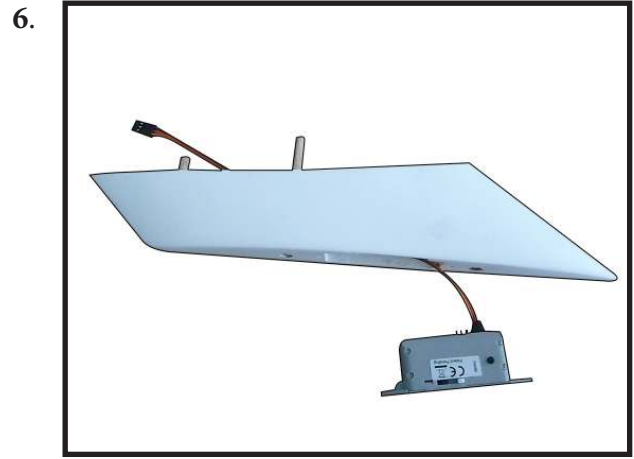
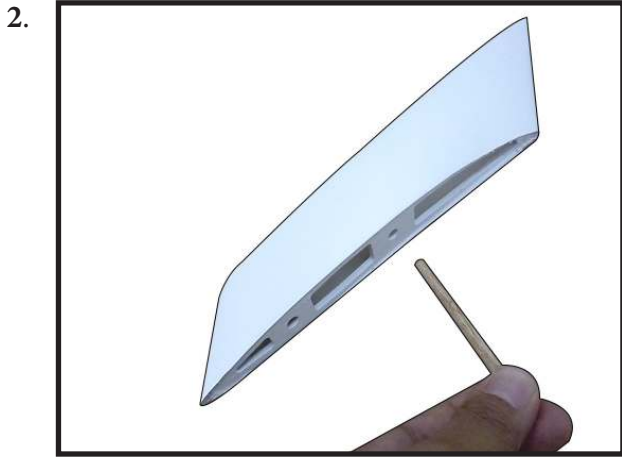

Install drop tank/bomb releases as shown.

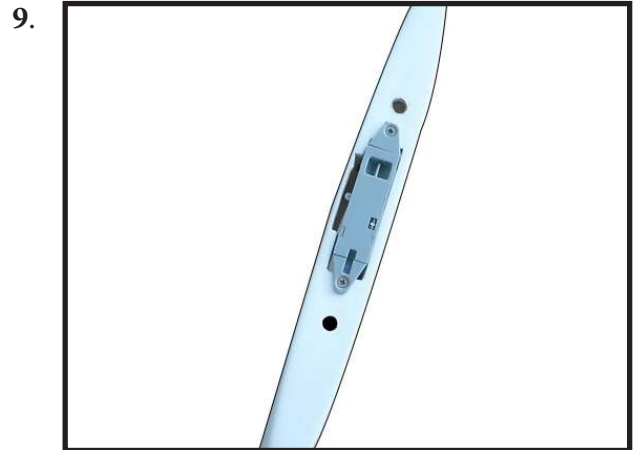
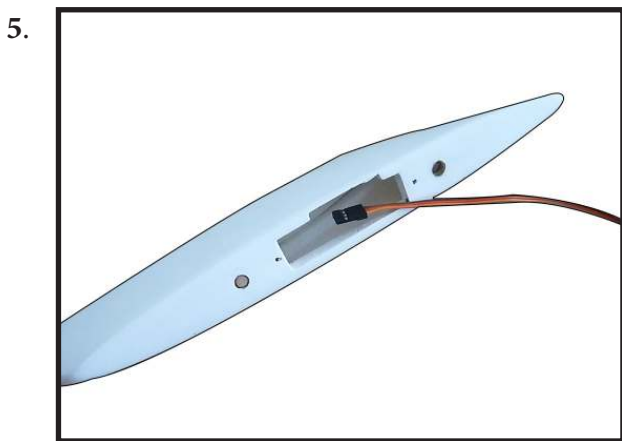
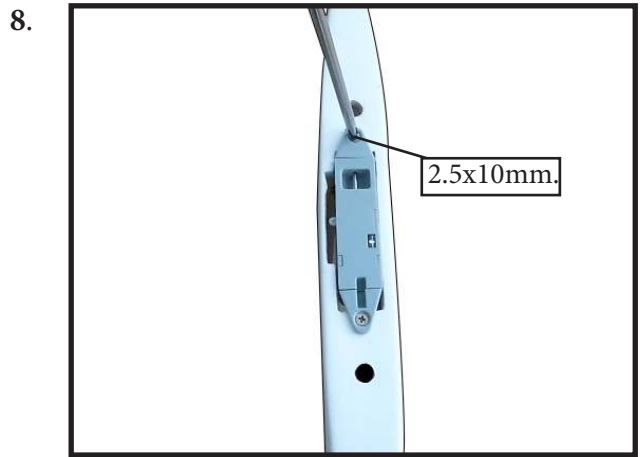
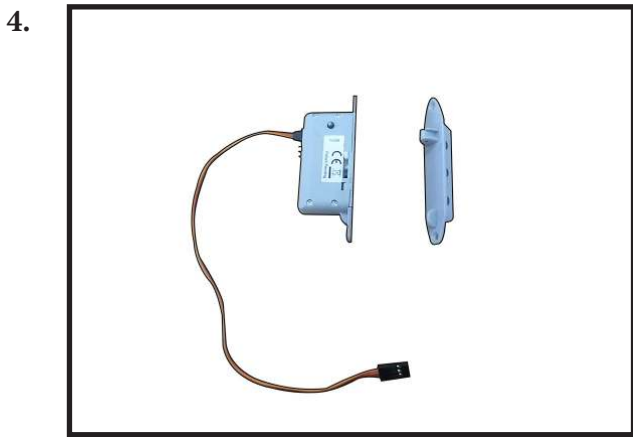

10.



14.

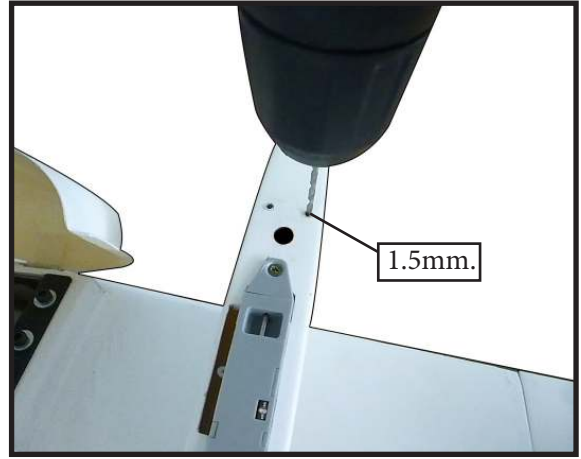

11.

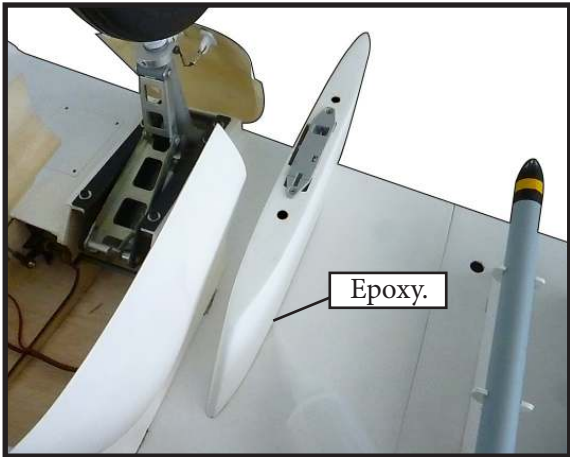

15.

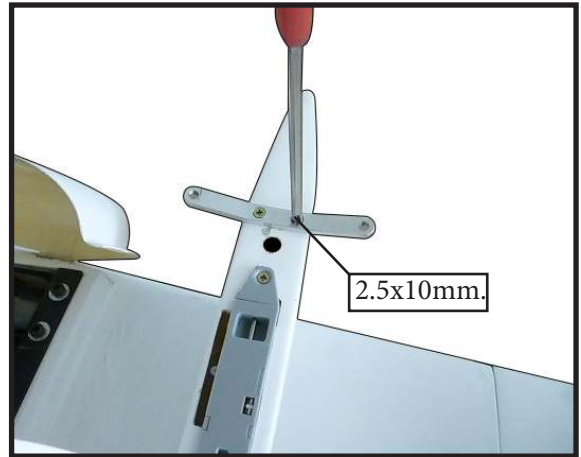

12.

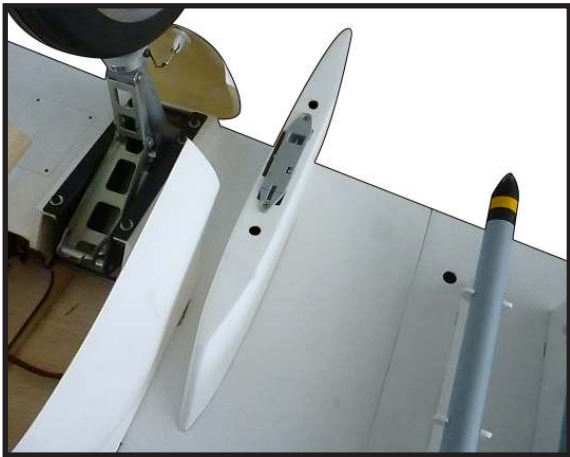

16.

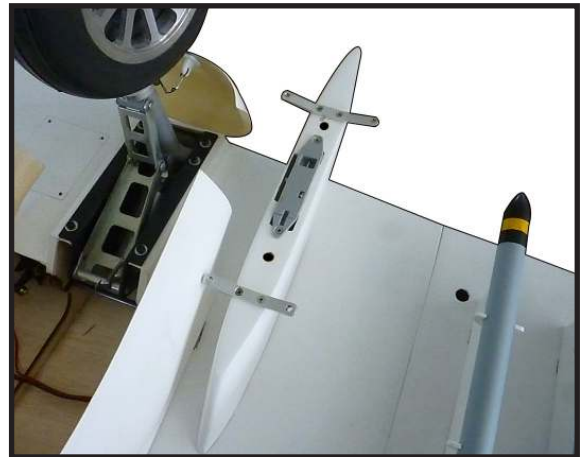

13.

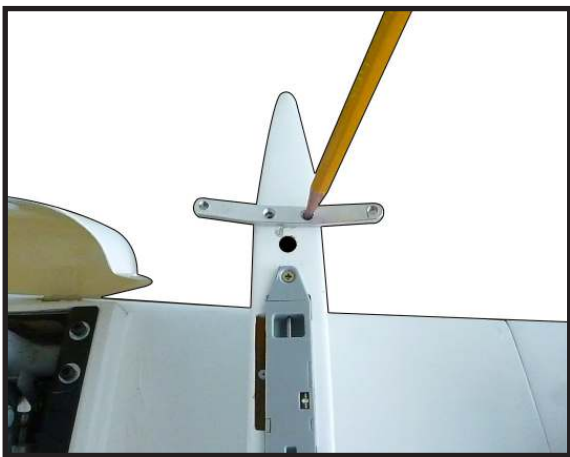

17.



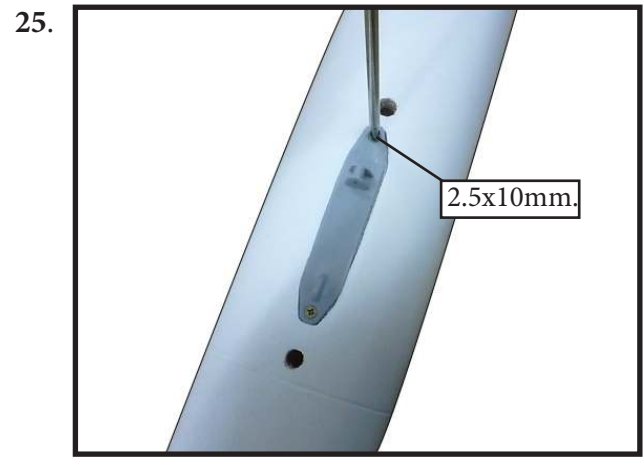
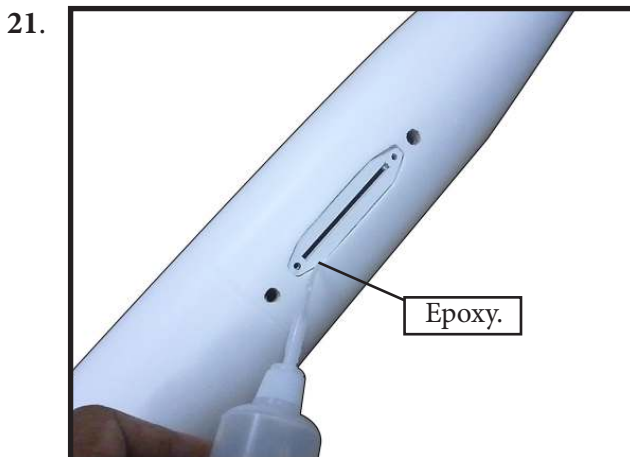
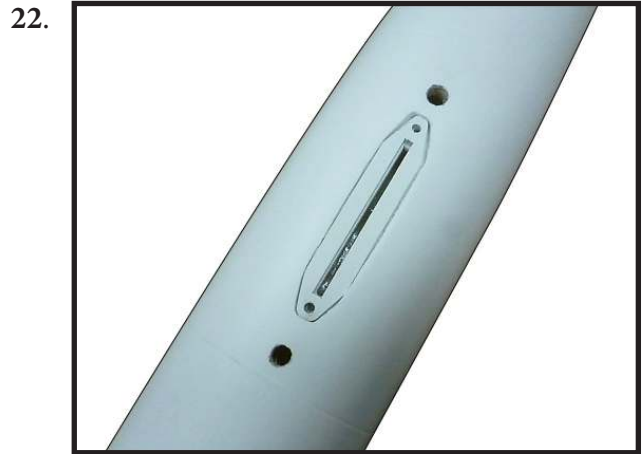

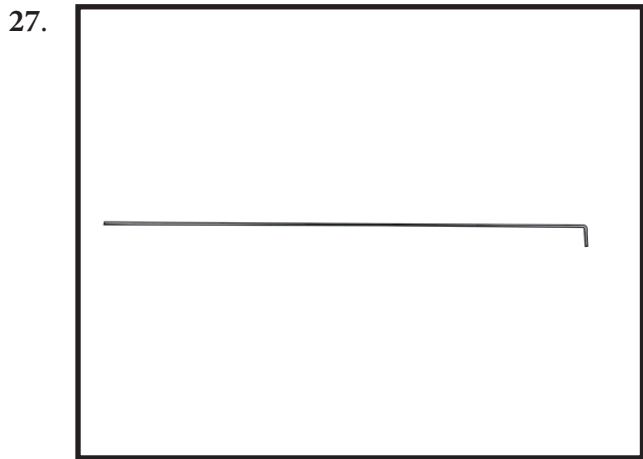
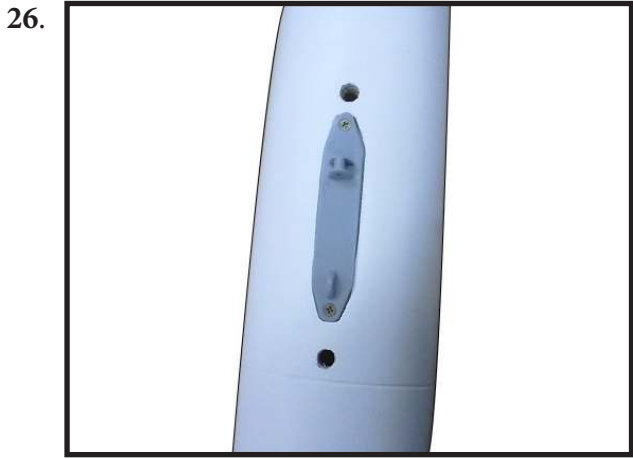

If you do not wish to make the drop tanks/bomb removable you may glue them in place. Please study images below. ***We do recommend making them removable for maintenance/service of your Skyraider.

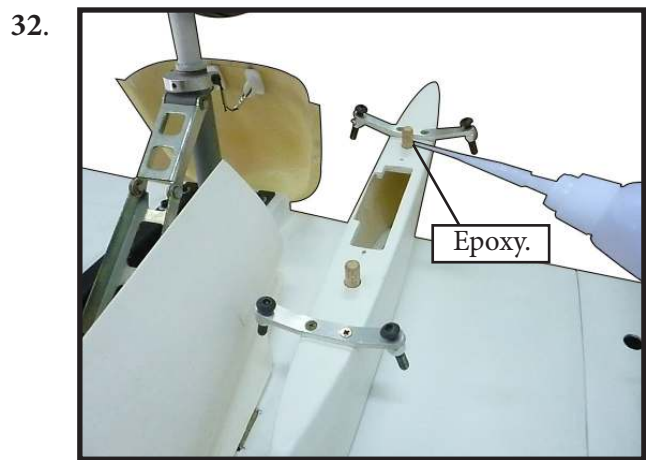
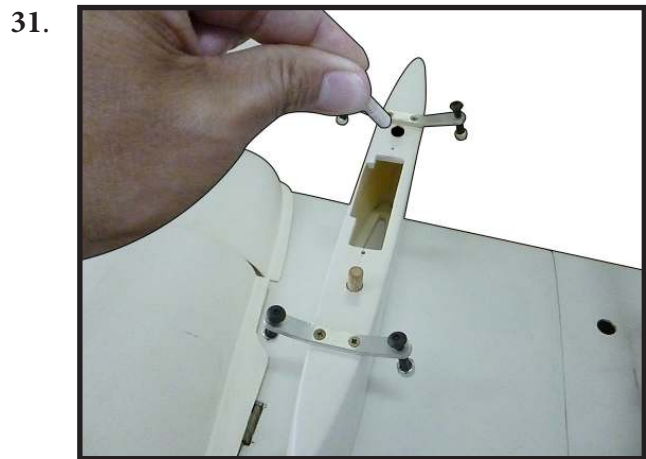
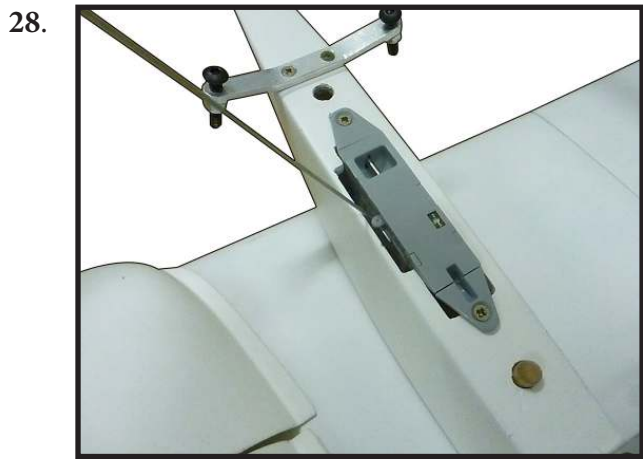

33.



37.

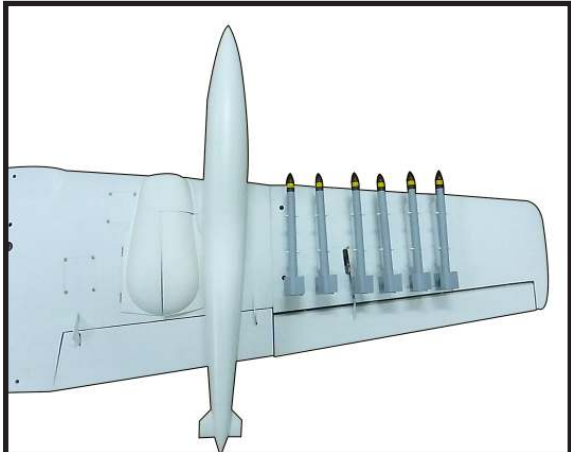

34.



38.

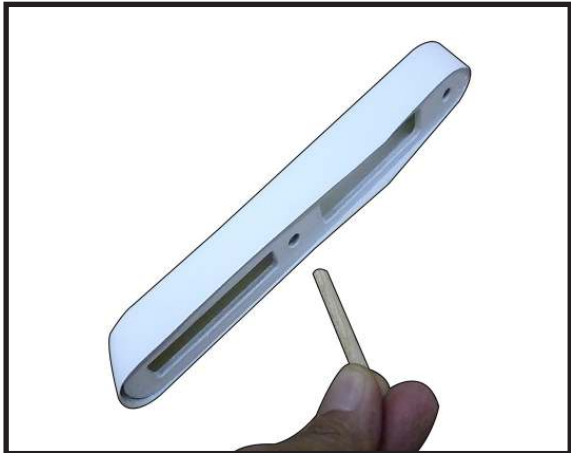

35.

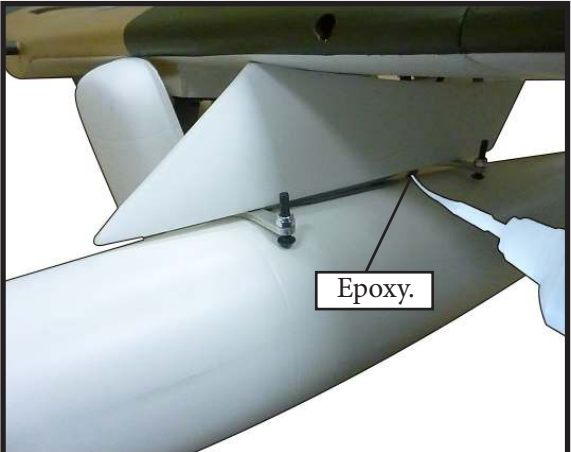

39.

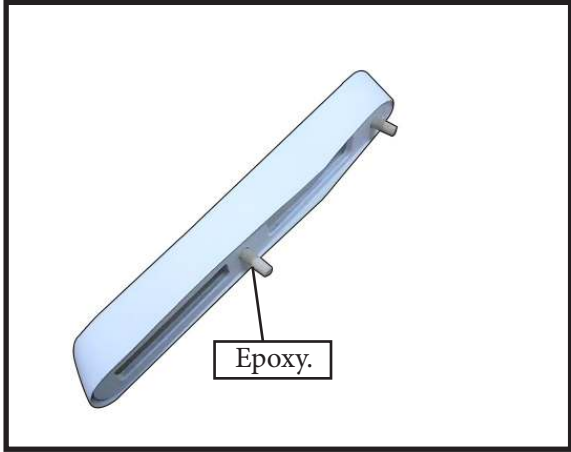

36.



40.

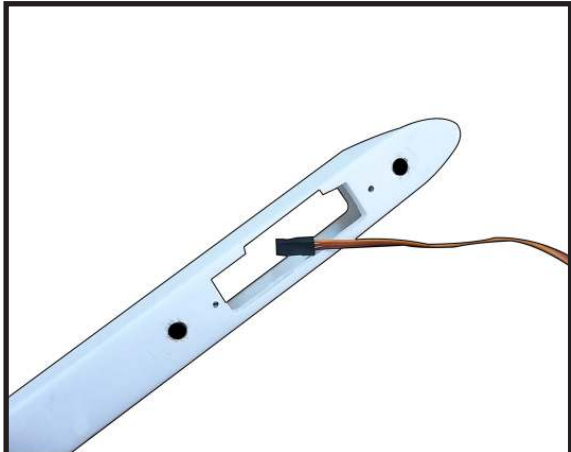

41.

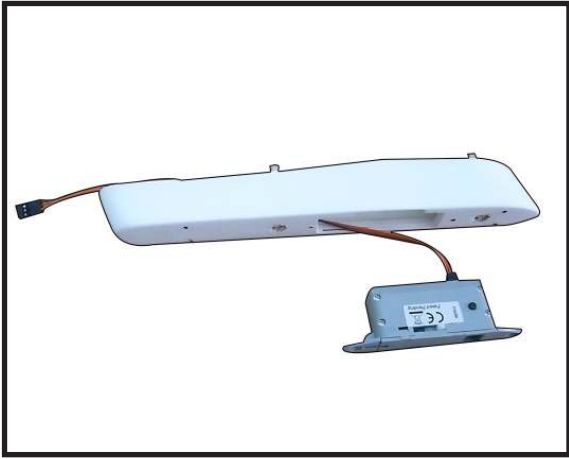

45.

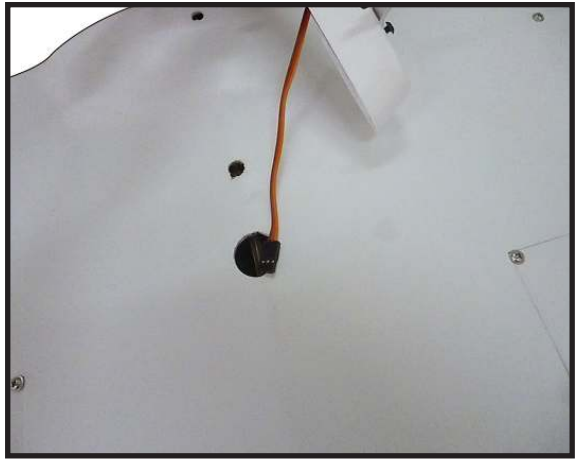

42.

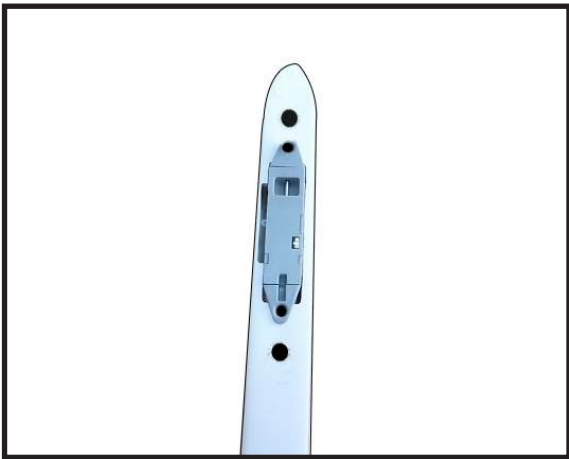

46.

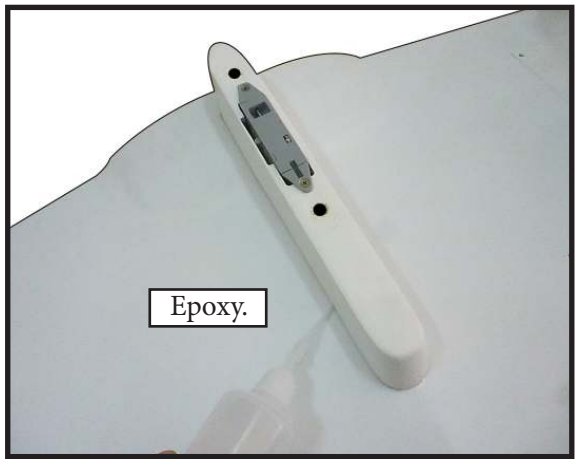

43.

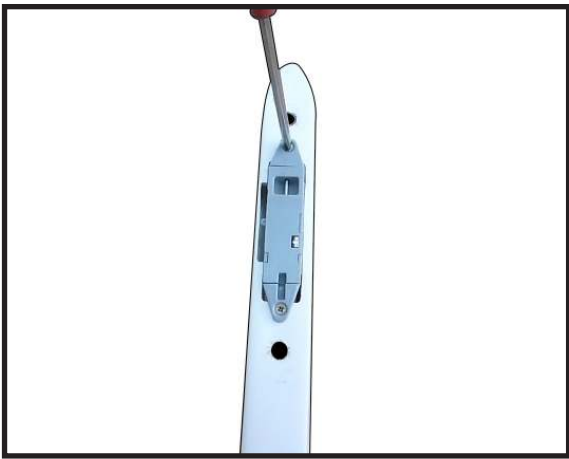

47.

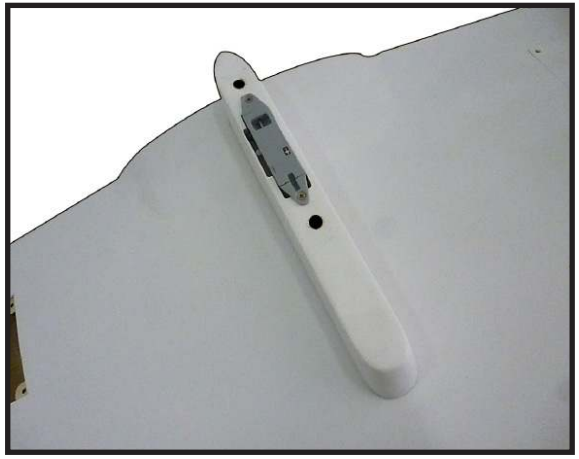

44.

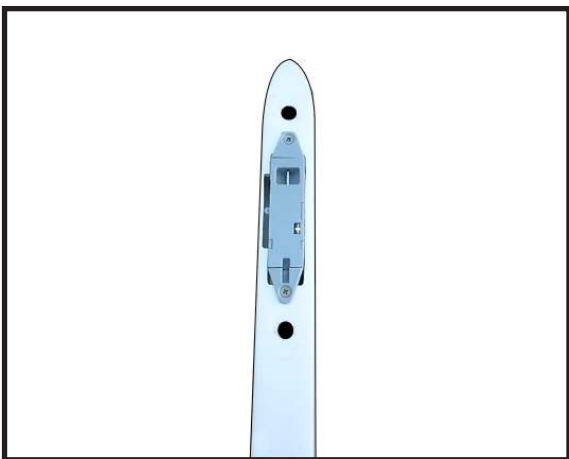

48.

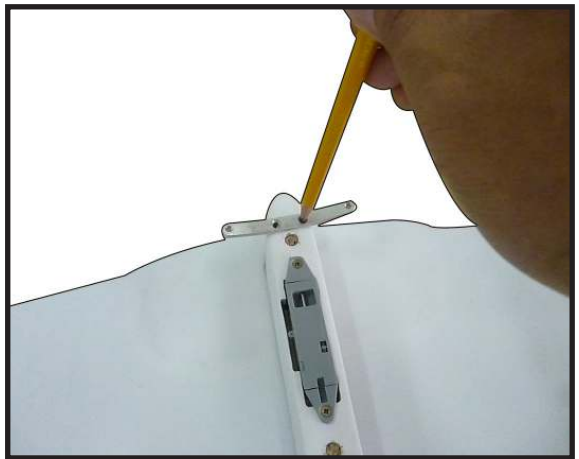

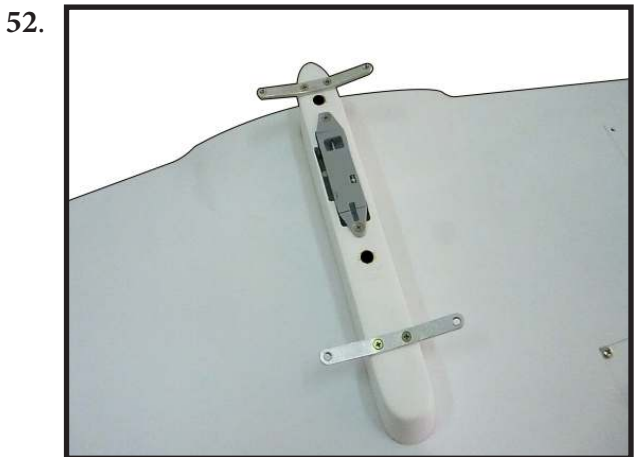
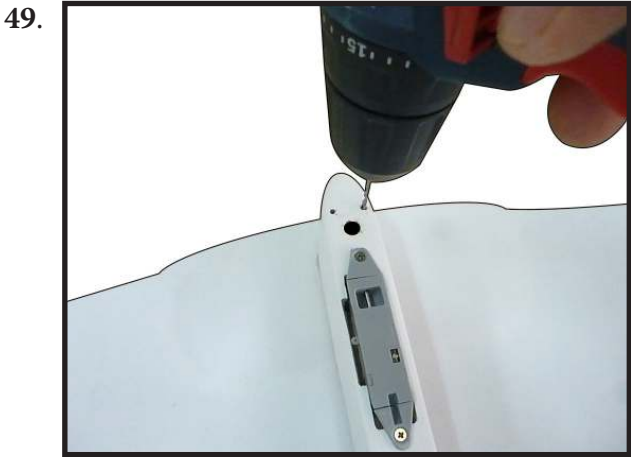

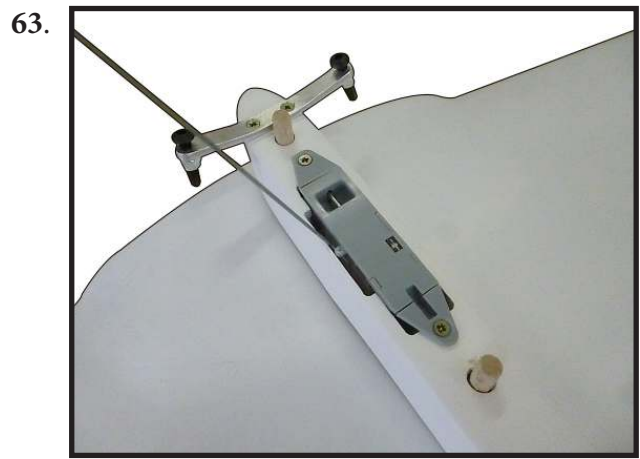
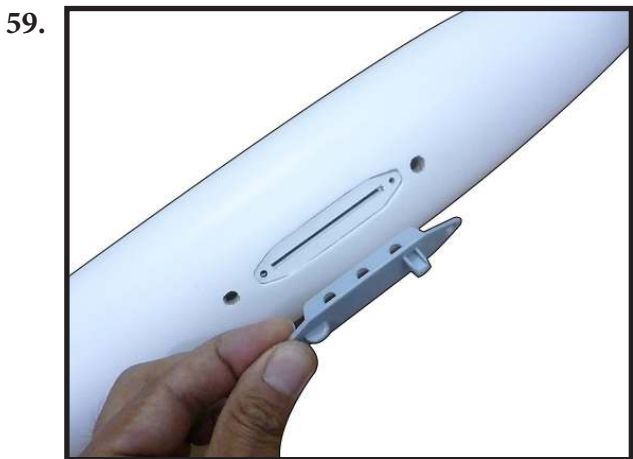
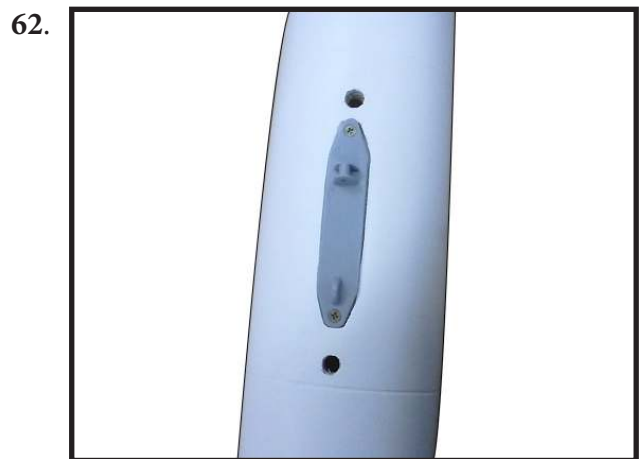
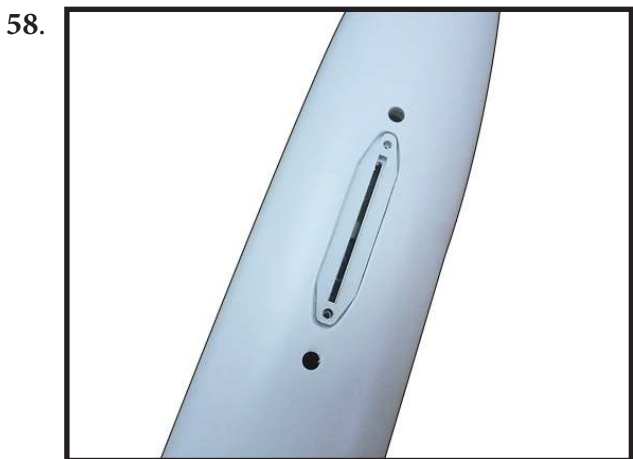
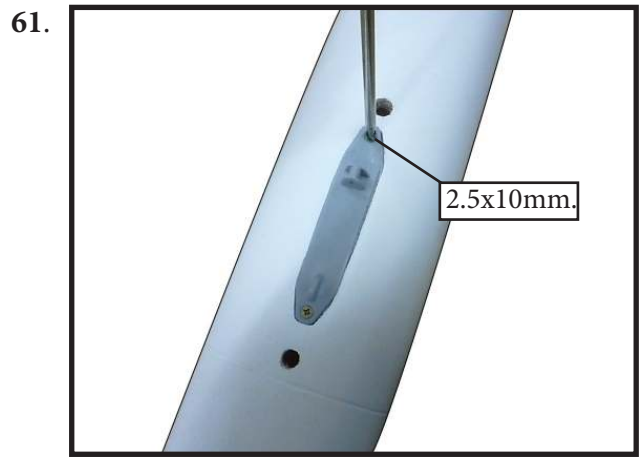
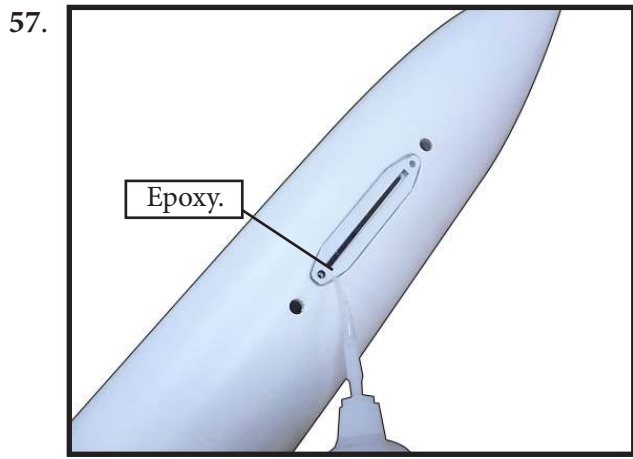

If you wish to make ordnance fixed you may permanently glue them in place. We recommend making them removable.

65.



66.



67.



68.

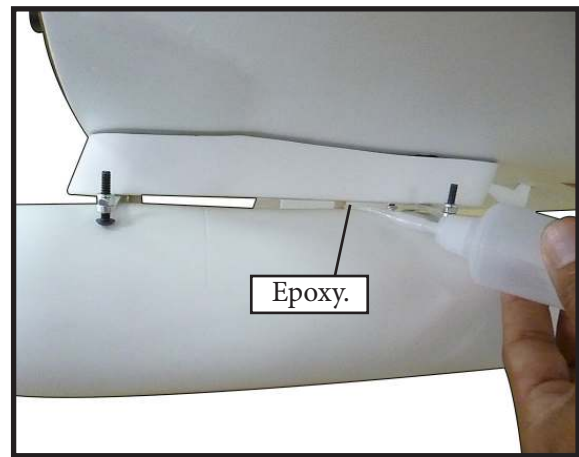

69.

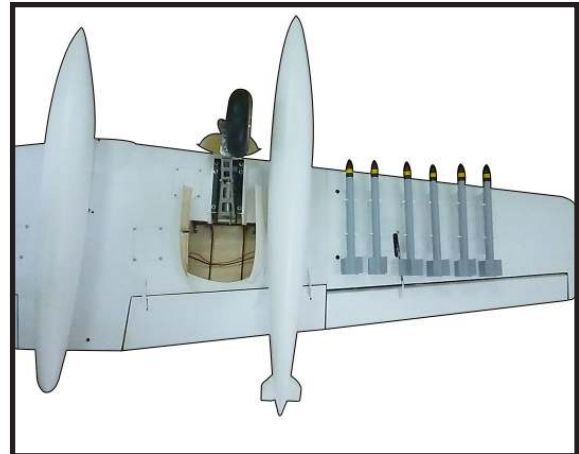

INSTALLING THE FUSELAGE SERVOS

! Because the size of servos differ, you may need to adjust the size of the precut opening in the mount. The notch in the sides of the mount allow the servo lead to pass through.

Secure the servos with the screws provided with your servo.

1.

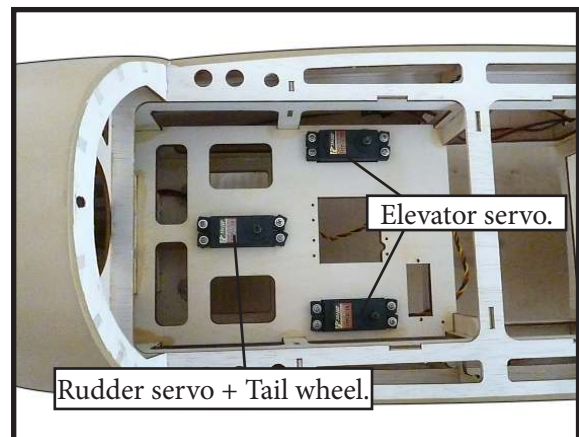

THROTTLE SERVO ARM INSTALLATION

Install adjustable servo connector on the servo arm and set aside for now.

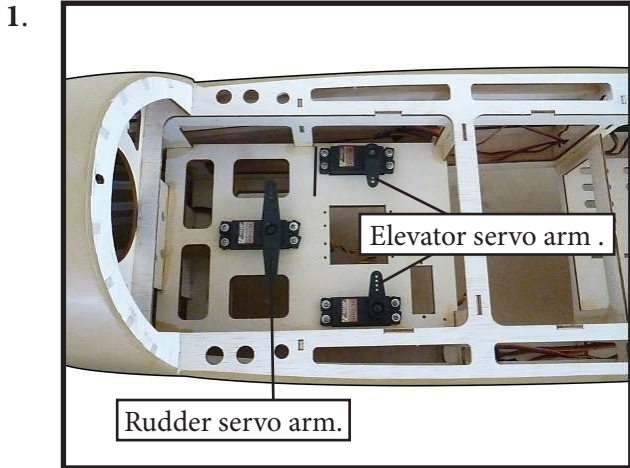

Install the rudder and elevator servo arms as shown above.

INSTALLING THE RECEIVER SWITCH

Install the switch into the precut hole in the side of fuselage, or you may hide switches under main hatch on a custom home made switch plate as desired.

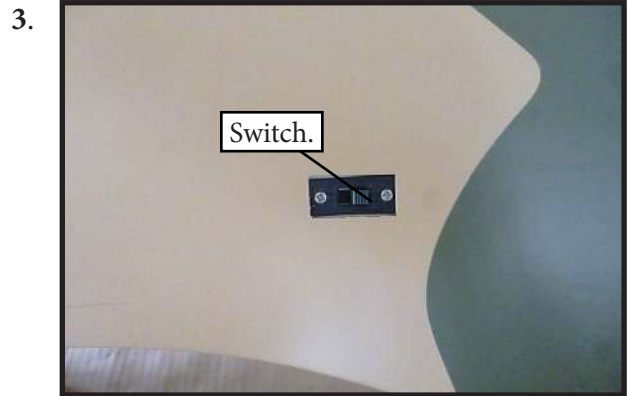
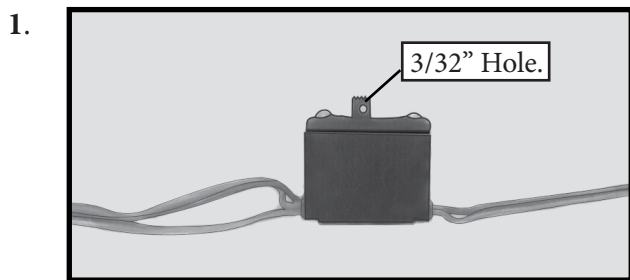

INSTALLING THE ENGINE SWITCH

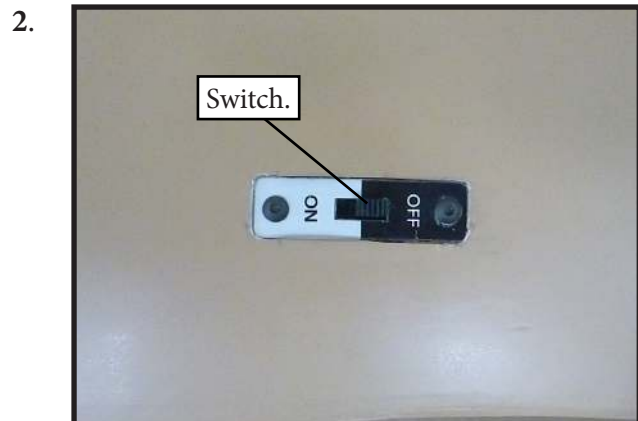
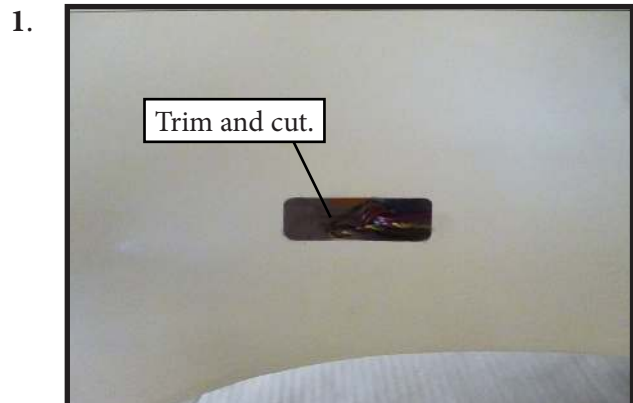

INSTALLING THE STOPPER ASSEMBLY

Using a modeling knife, carefully cut off the rear portion of one of the 3 brass tubes leaving 1/2" protruding from the rear of the stopper. This will be the fuel pick up tube.

Using a modeling knife, cut one length of silicone fuel line. Connect one end of the line to the weighted fuel pick up and the other end to the brass pick up tube.

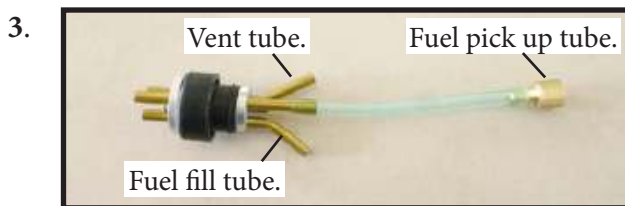
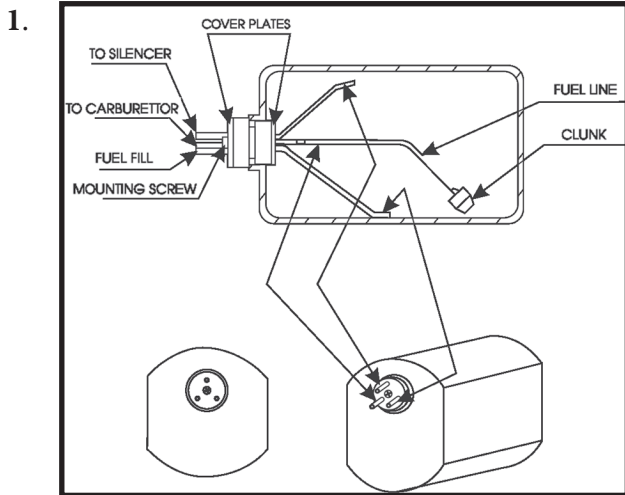

Carefully bend the second brass tube up at a 45° angle. This tube is the vent tube.

Test fit the stopper assembly into the tank. It may be necessary to remove some of the flashing around the tank opening using a modeling knife. If flashing is present, make sure none falls into the tank.

With the stopper assembly in place, the weighted pick-up should rest away from the rear of the tank and move freely inside the tank. The top of the vent tube should rest just below the top of the tank. It should not touch the top of the tank.

When satisfied with the alignment of the stopper assembly tighten the 3x20mm machine screw until the rubber stopper expands and seals the tank opening. Do not overtighten the assembly as this could cause the tank to split.

FUEL TANK INSTALLATION

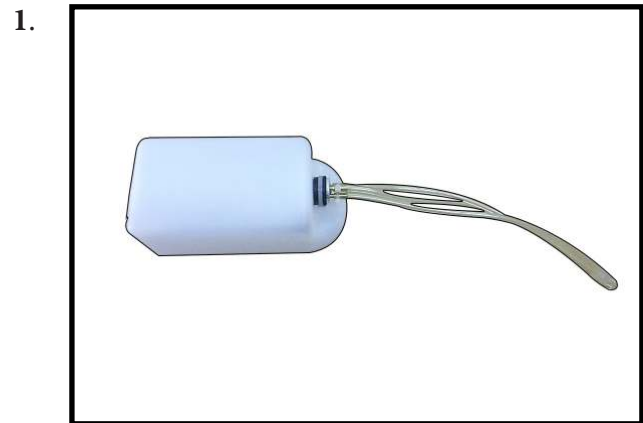

! You should mark which tube is the vent and which is the fuel pickup when you attach fuel tubing to the tubes in the stopper. Once the tank is installed inside the fuselage, it may be difficult to determine which is which.



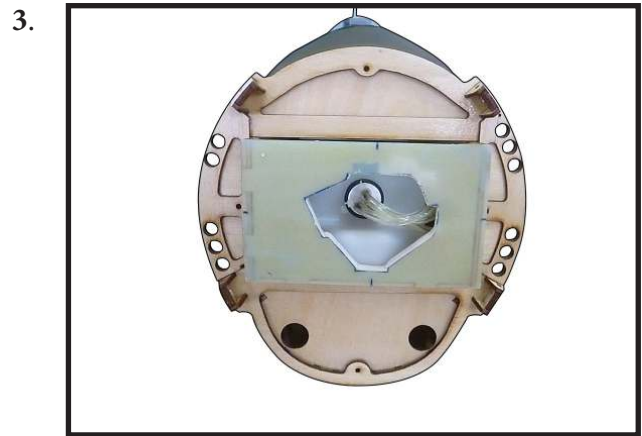
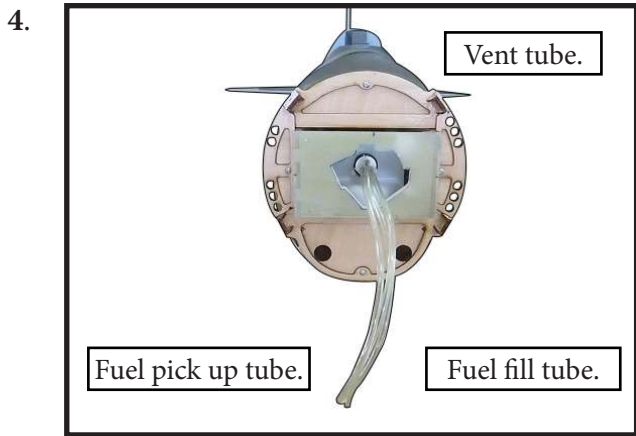

Later you will connect the lines from the tank to the engine and muffler. The vent line will connect to the muffler and the line from the clunk to the carburetor.

! *Blow through one of the lines to ensure the fuel lines have not become kinked inside the fuel tank compartment. Air should flow through easily.*

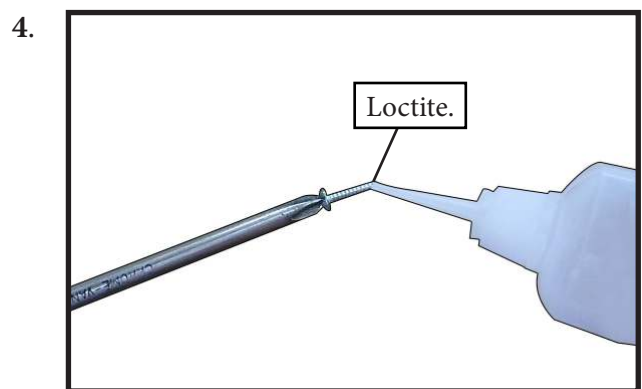

MOUNTING THE ENGINE

Please study the images below.

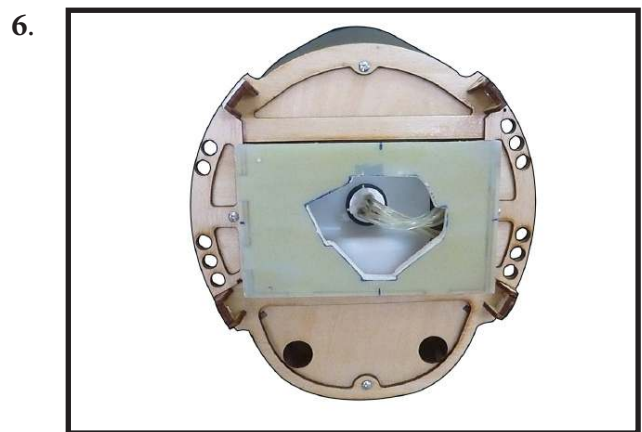
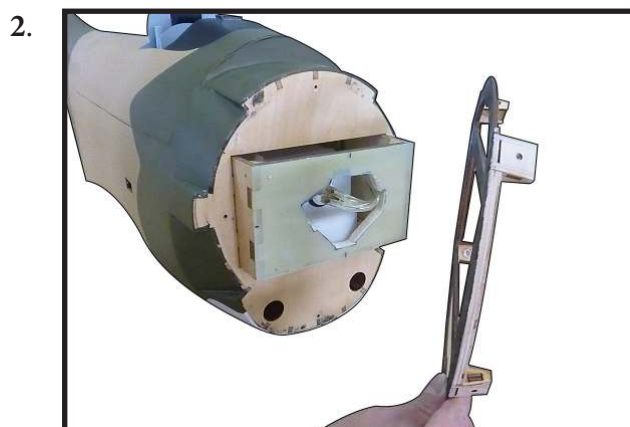
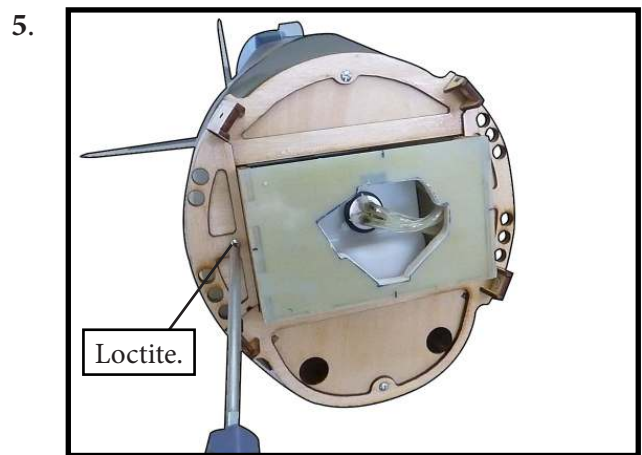
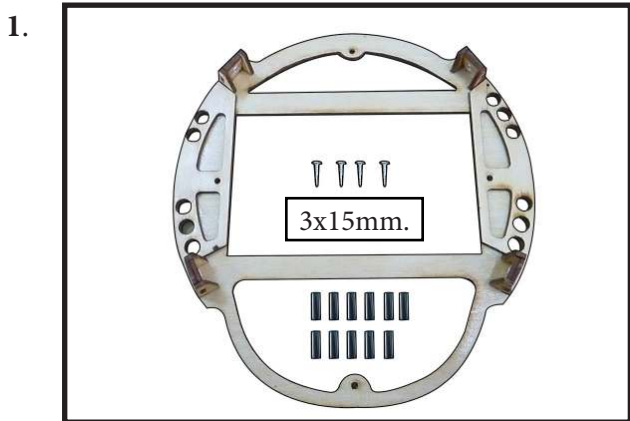

Install the black simulated exhaust tubes.

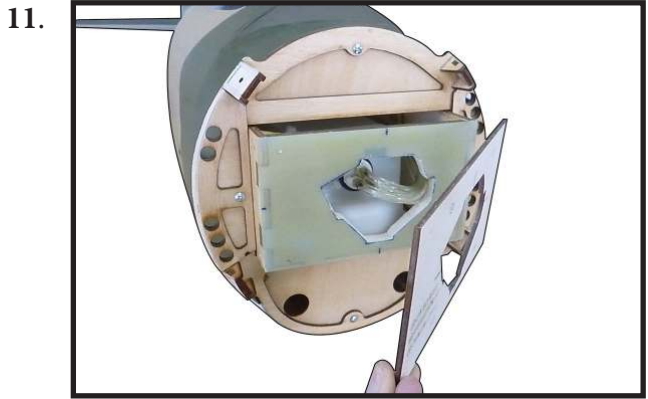
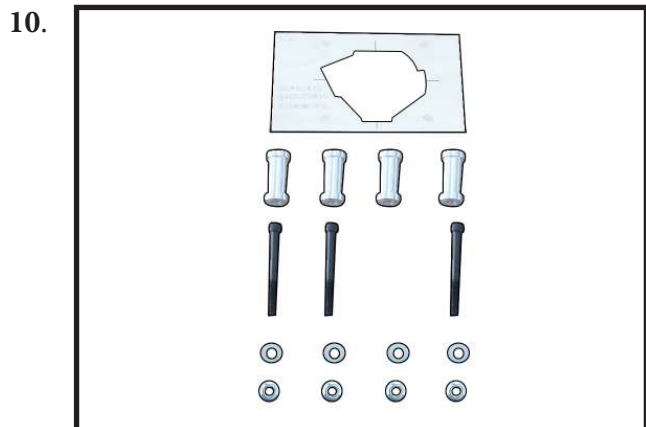
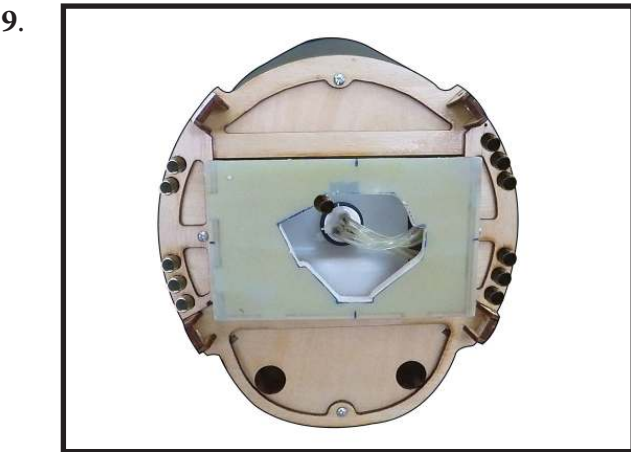
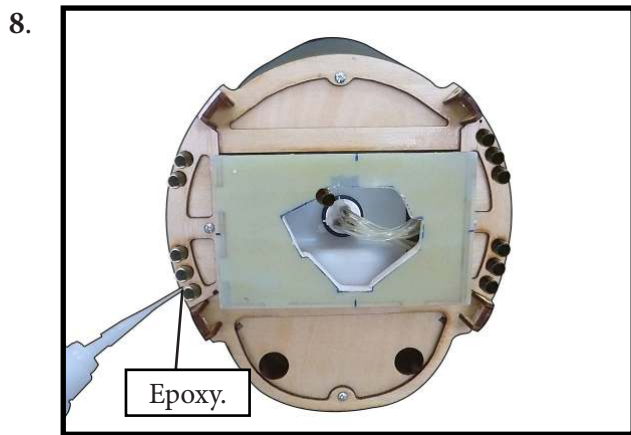
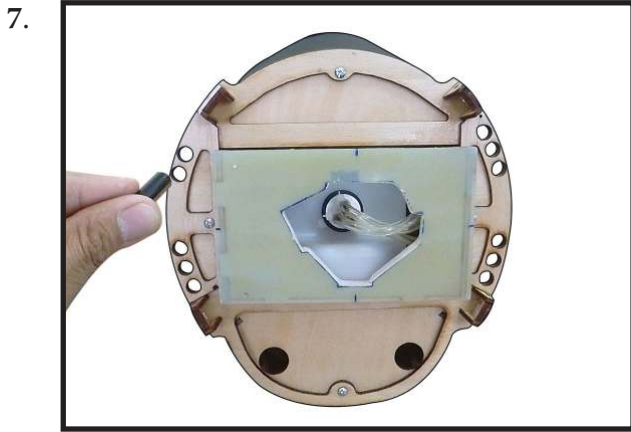

Locate the engine mounting in position on the firewall. Use a 2.5mm drill bit to drill the holes necessary to mount your particular engine choice.

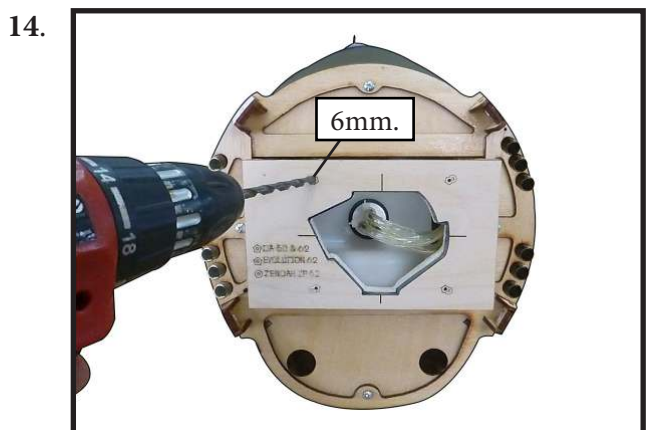
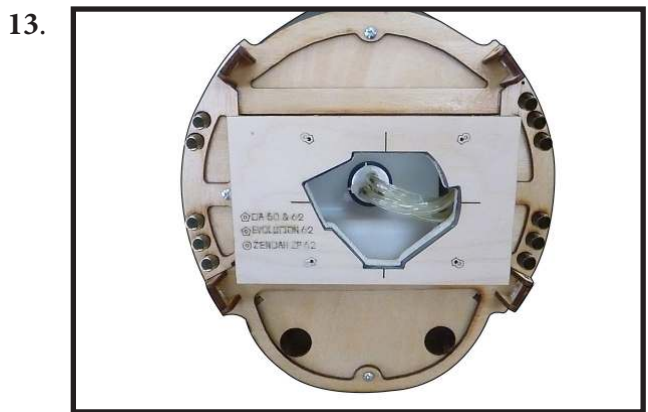
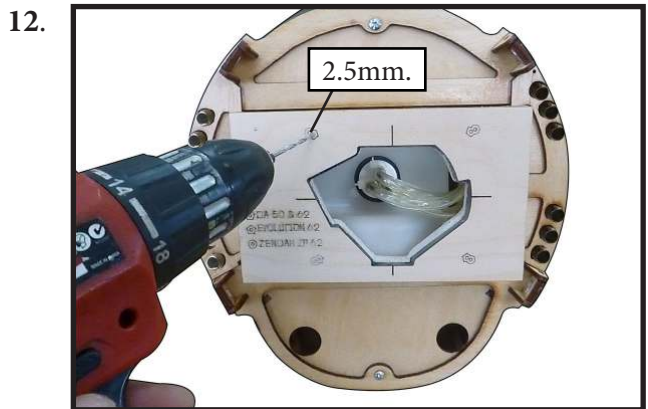

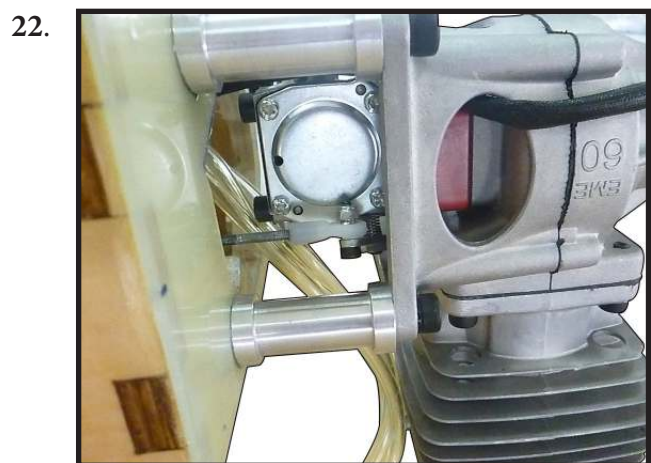
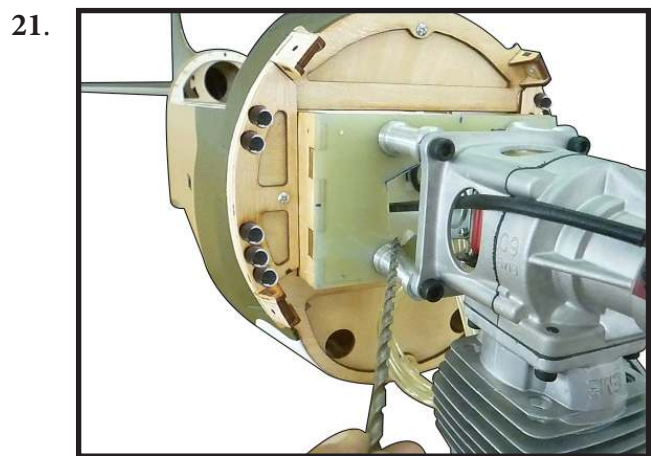
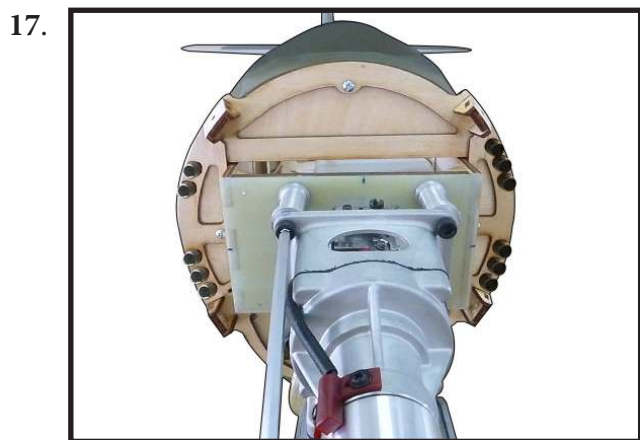
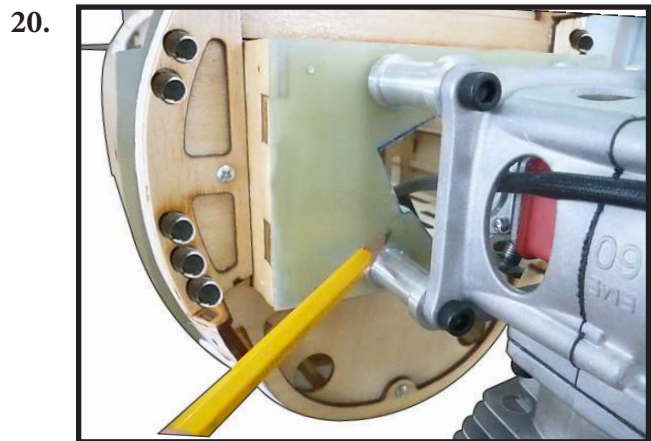
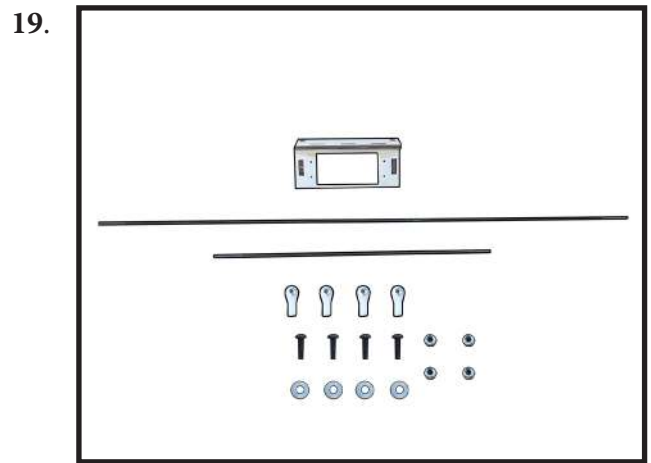
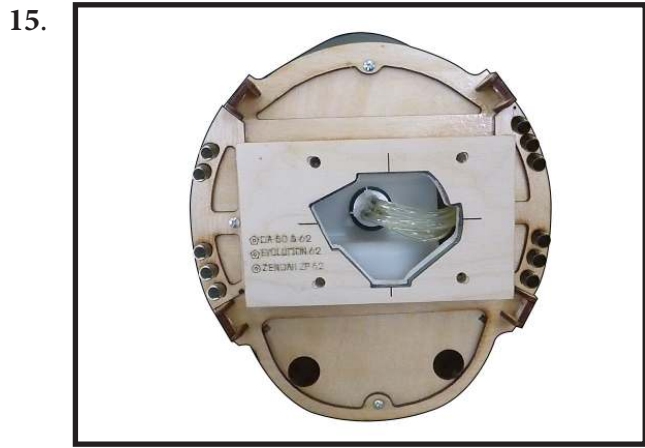

Inside view of the gas engine, carb, connector.

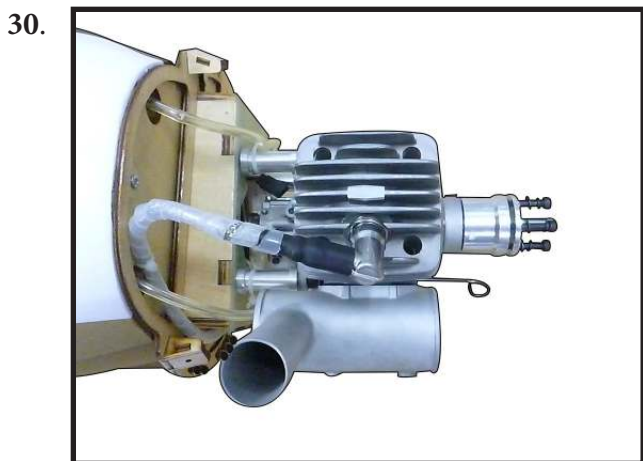
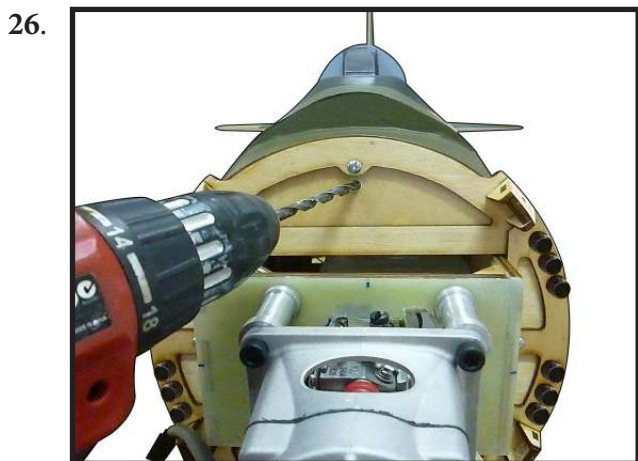
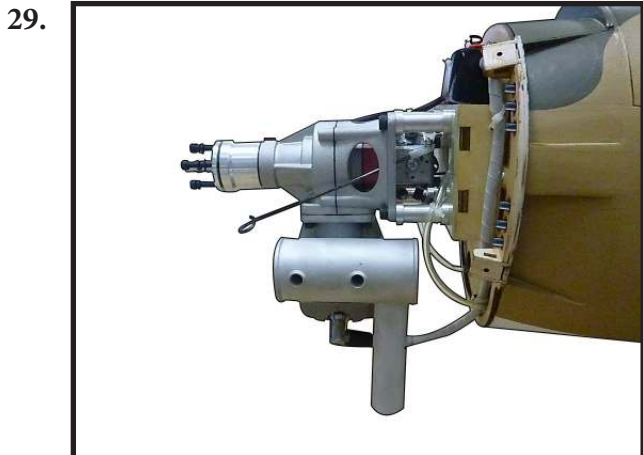
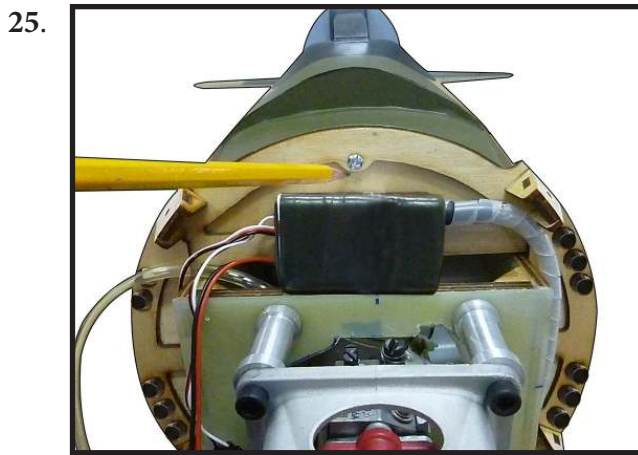
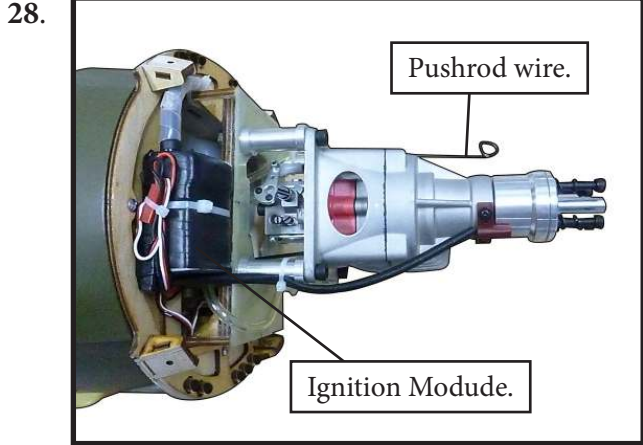
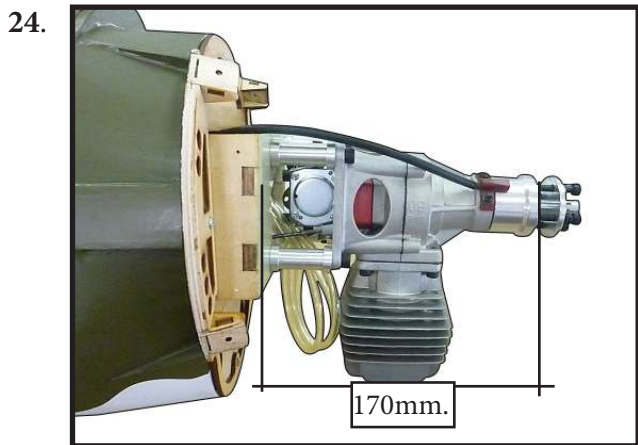
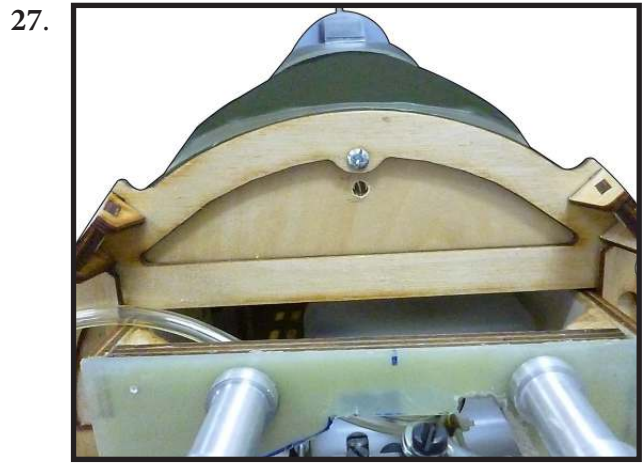
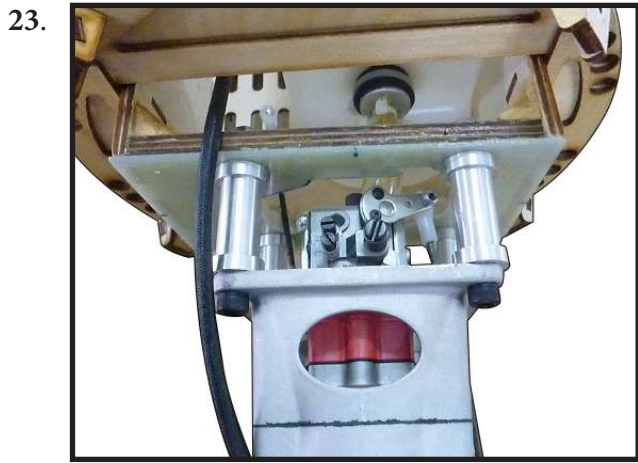

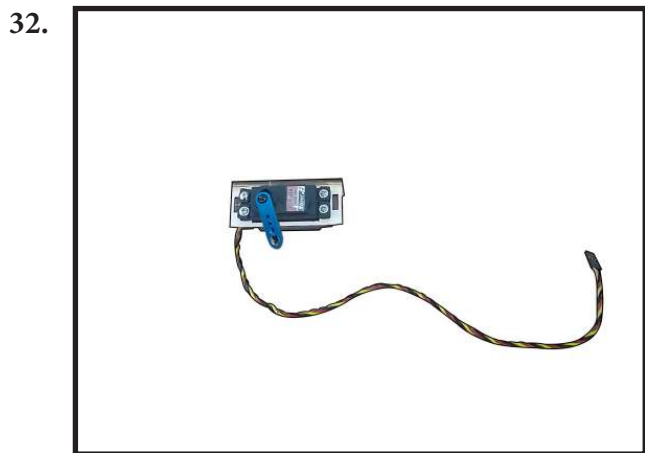
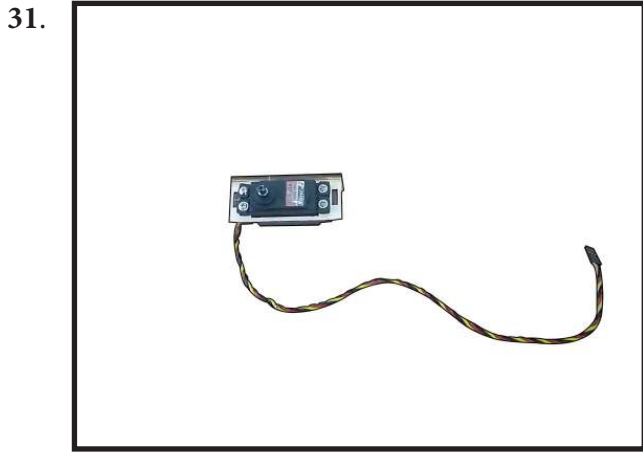

Move the throttle stick to the closed position and move the carburetor to closed.

Use a 3x10mm hex wrench to tighten the screw that secures the throttle pushrod wire. Make sure to use threadlock on the screw so it does not vibrate loose.

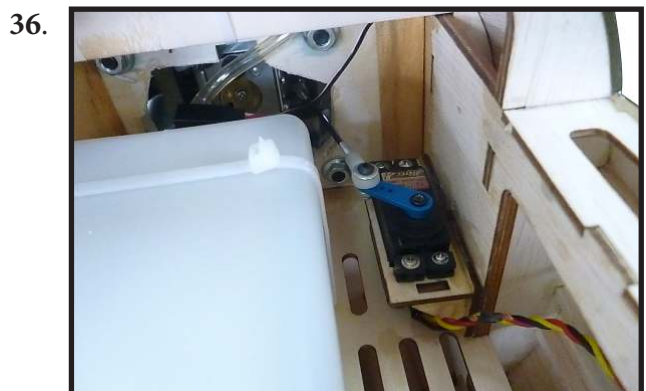

Reinstall the servo horn by sliding the connector over the pushrod wire. Center the throttle stick and trim and install the servo horn perpendicular to the servo center line.

COWLING & ENGINE BAFFLE

Please study images below.

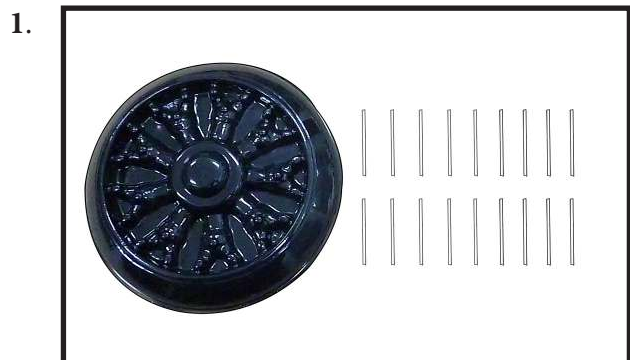

2.



6.



3.



7.



4.



8.



5.



9.



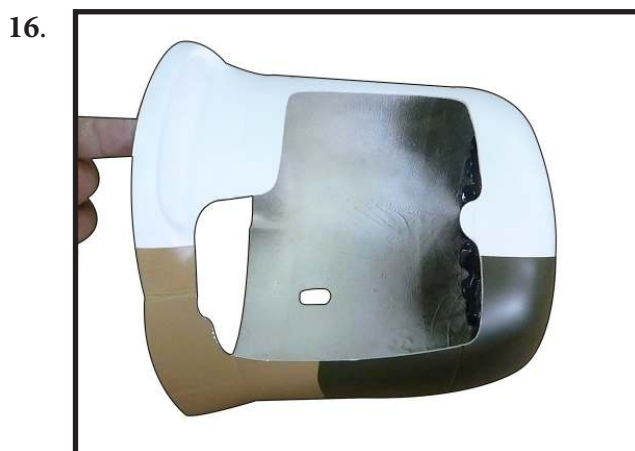
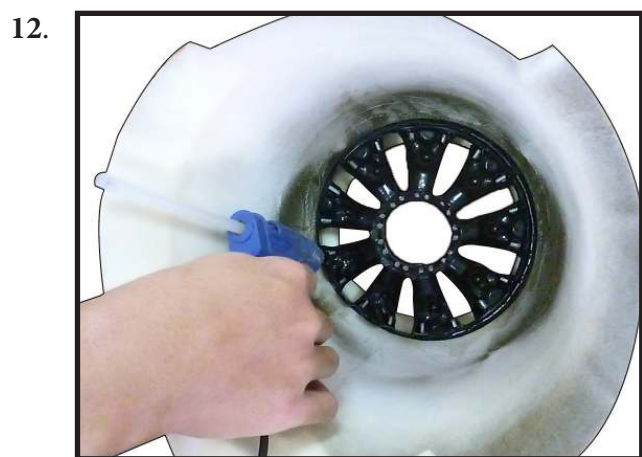

Tape the cowl to the fuselage using low-tack tape.

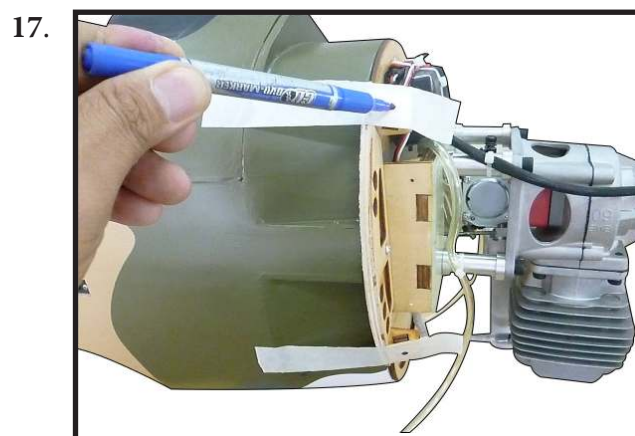

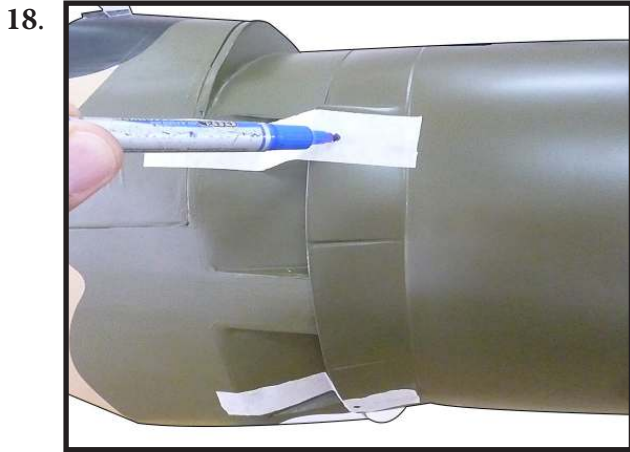

Use a drill and drill bit to drill the holes for the cowl mounting screws. Make sure the cowl position is correct before drilling each hole.

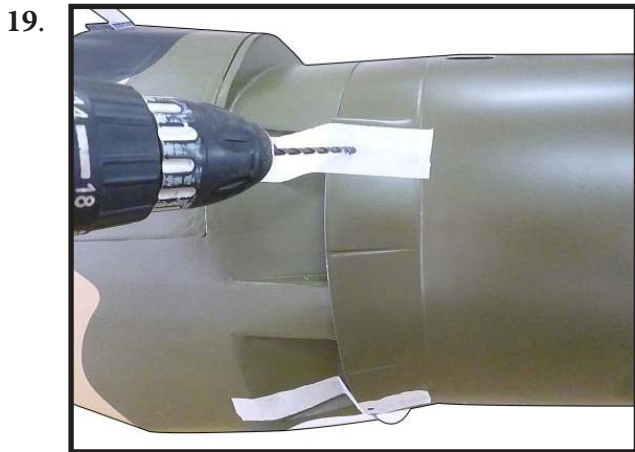

Install the muffler onto the engine and make the cutout in the cowl for muffler clearance. Connect the fuel and pressure lines to the carburetor, muffler and fuel filter valve. Secure the cowl to fuselage using the M3x10mm socket head screws. Putting a small length of silicone fuel tube under the head of the screw helps with vibration.

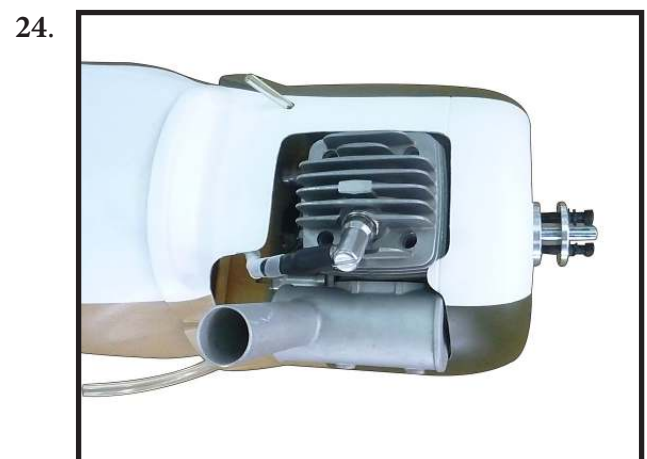
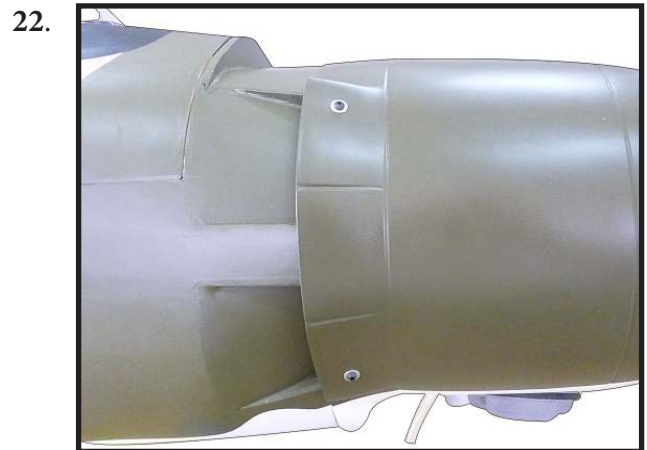
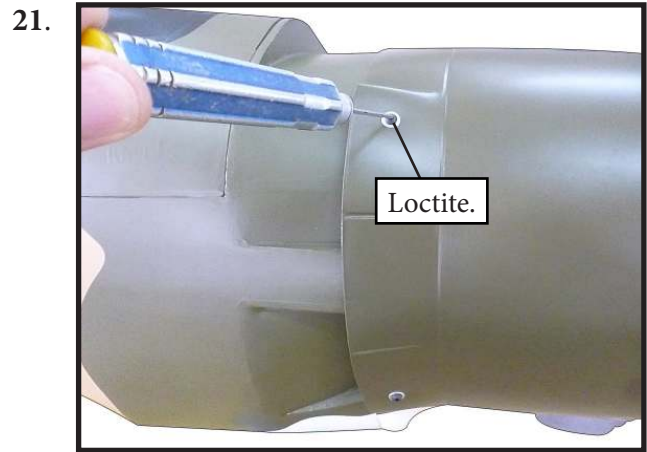
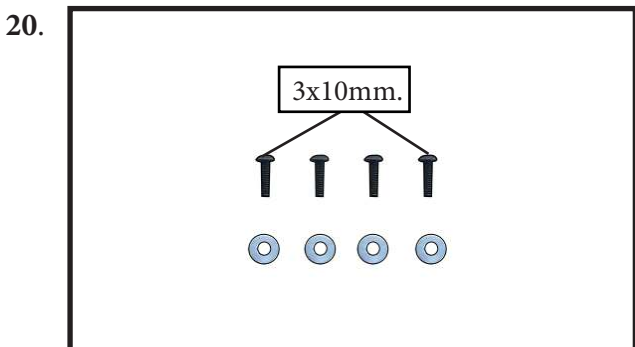

25.



INSTALLING THE PROP/HUB

Install the spinner backplate, propeller and proper hub of your choice.

1.



 The propeller should not touch any part of the cowling. If it does, check and adjust engine mounting/cowl spacing as needed to where the propeller will not come in contact with the cowling.

2.



INSTALL ELEVATOR HINGES

Test fit the hinges into the elevator, and then the hinges into the horizontal stabilizer. Ensure that the hinge pockets line up, and that the hinges move freely. Epoxy hinge the same way you did the aileron hinges.

1.

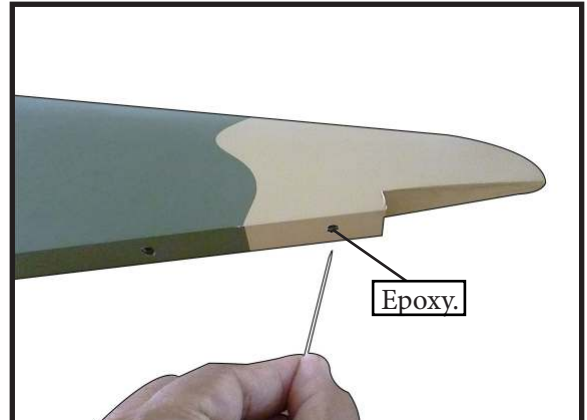

2.

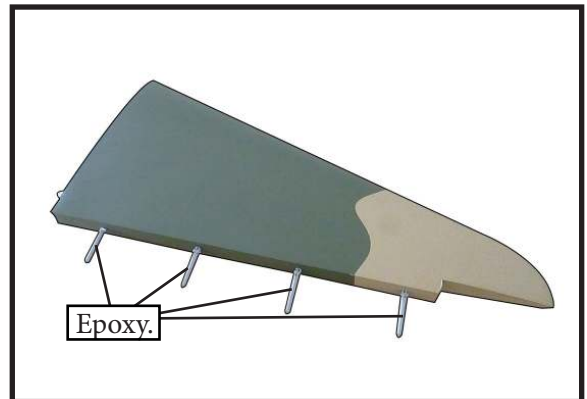

3.

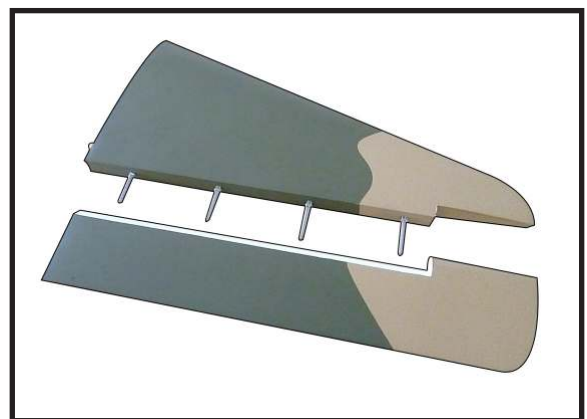

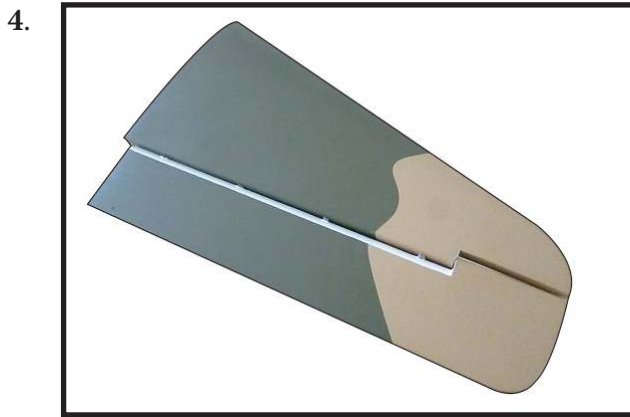

INSTALL ELEVATOR CONTROL HORN

Install the elevator control horn using the same method as same as the flap control horns.

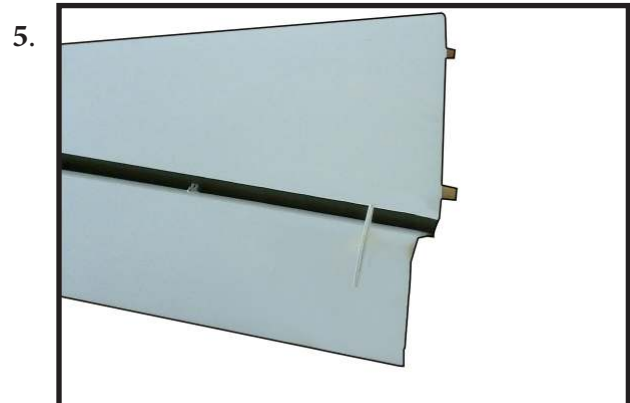
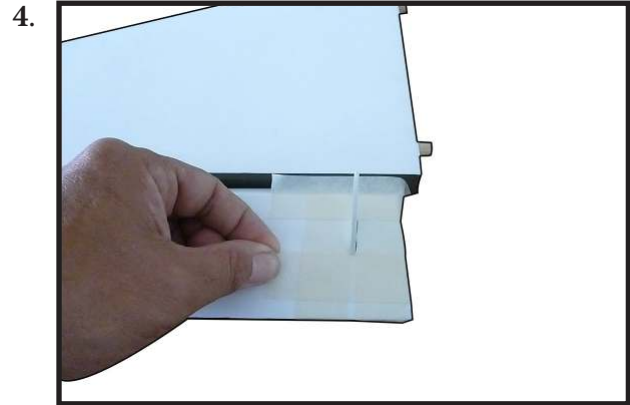
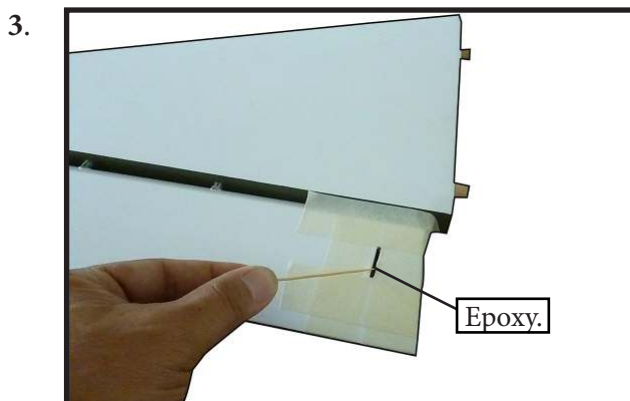
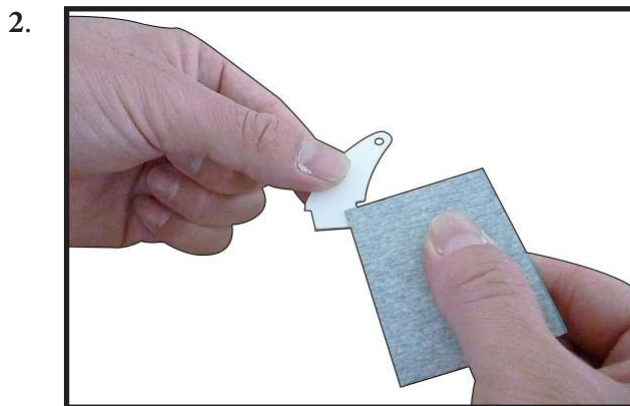
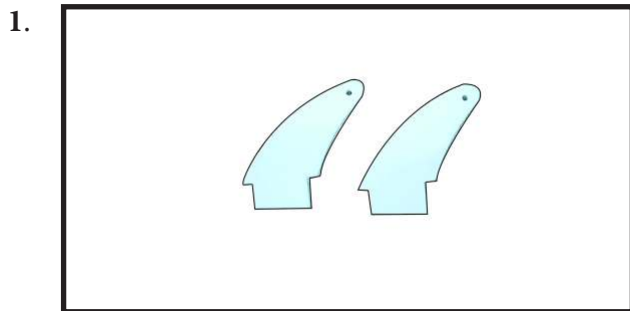

INSTALL RUDDER CONTROL HORN

Install the rudder control horn using the same method as the aileron control horns.

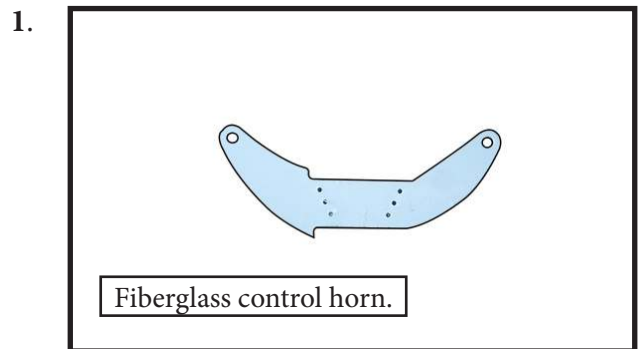

Fiberglass control horn.

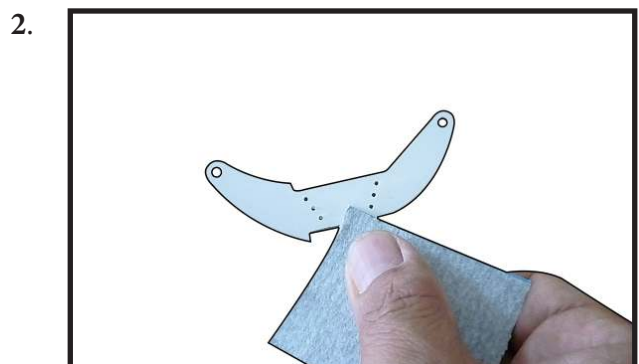

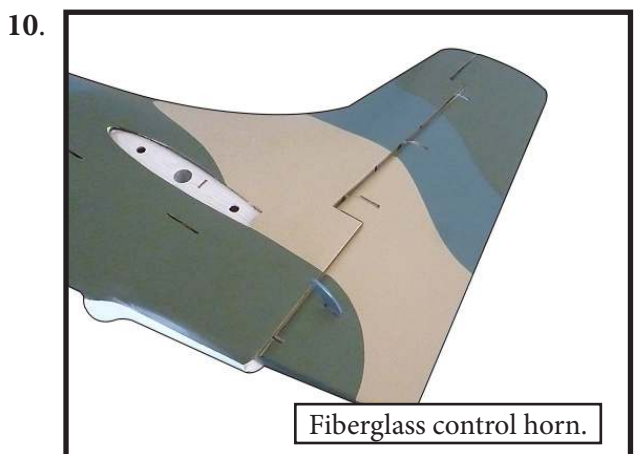
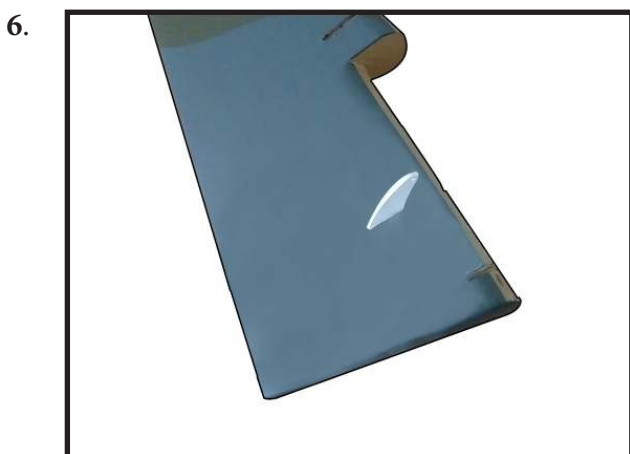
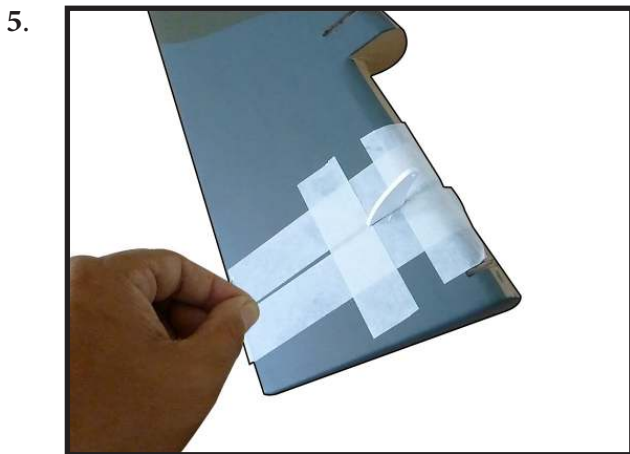
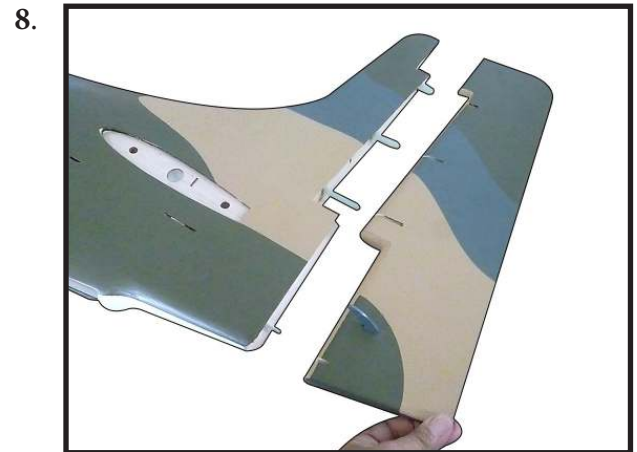
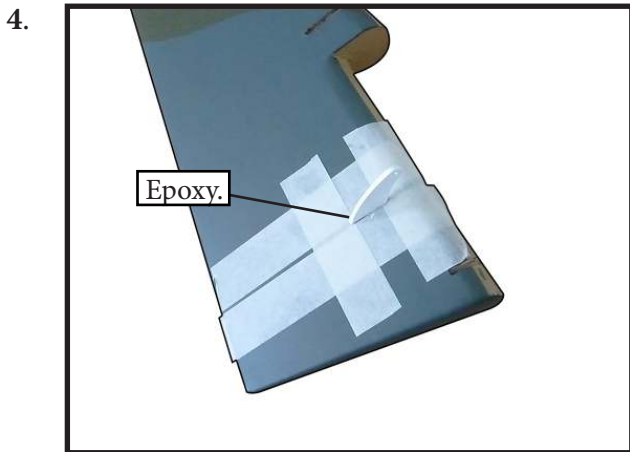
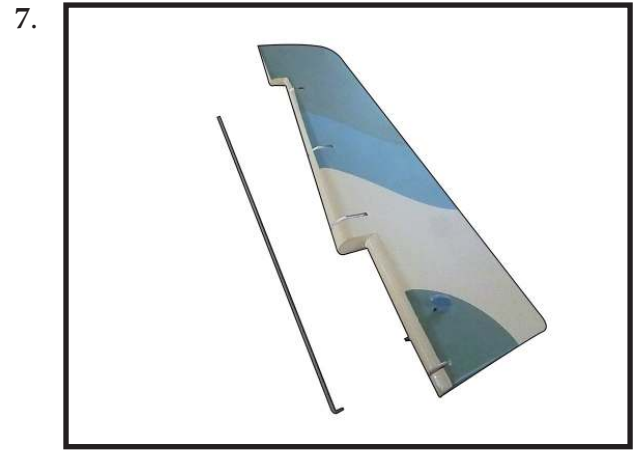
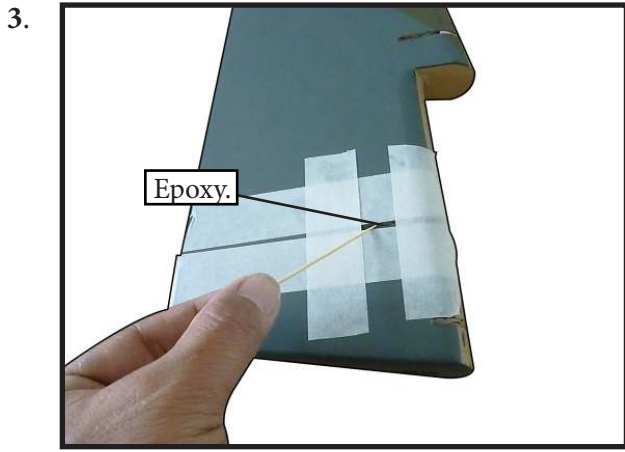

INSTALLING HORIZONTAL STABILIZER

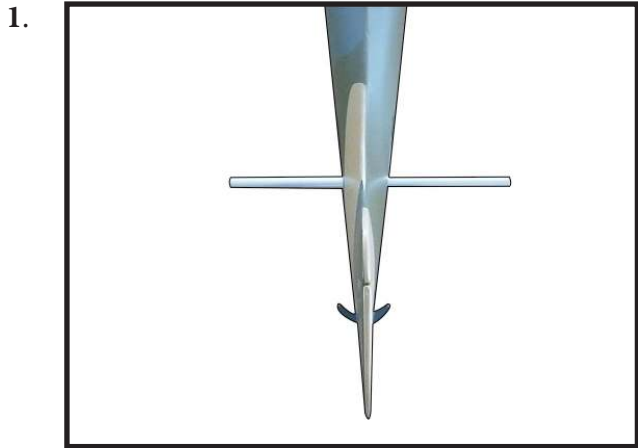

Use Epoxy to glue the Horizontal Stabilizer to the fuselage.

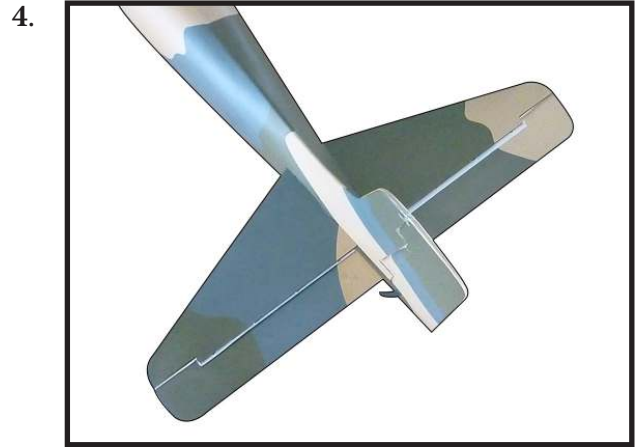
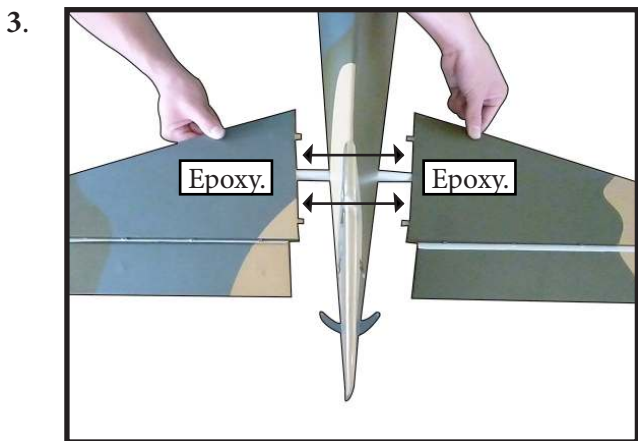
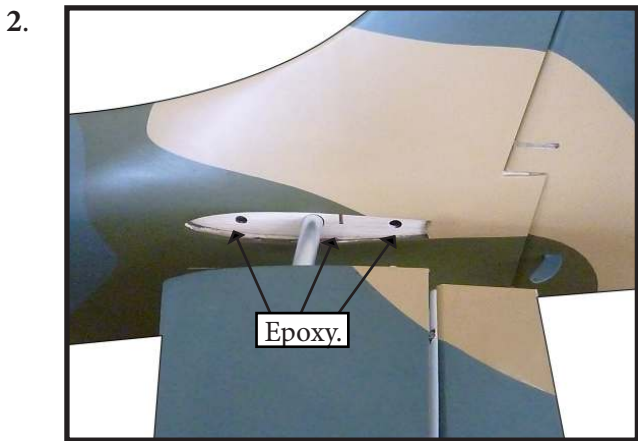

ELEVATOR PUSHROD HORN INSTALLATION

Install the elevator control horn using the same method as with the aileron control horns.

Position the elevator control horns on both side of the elevator.

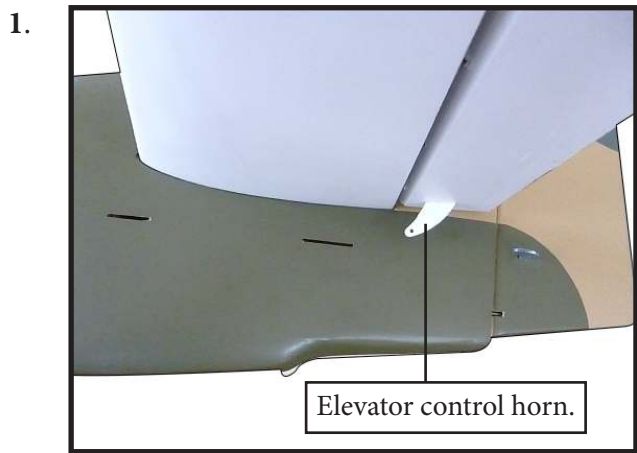

Thread one clevis and M3 lock nut on to each elevator control rod. Thread the horns on until they are flush with the ends of the control rods.

Assemble the elevator and rudder pushrods as shown in images below.

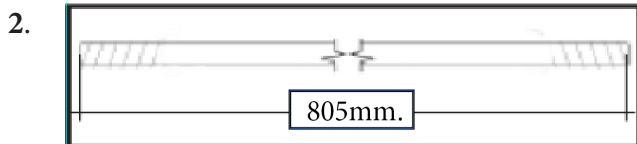

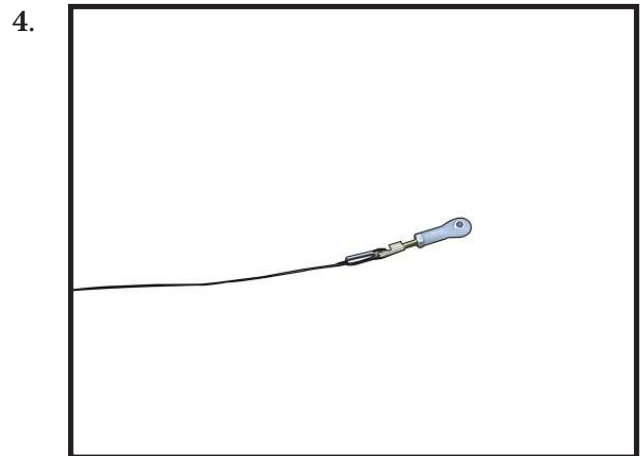
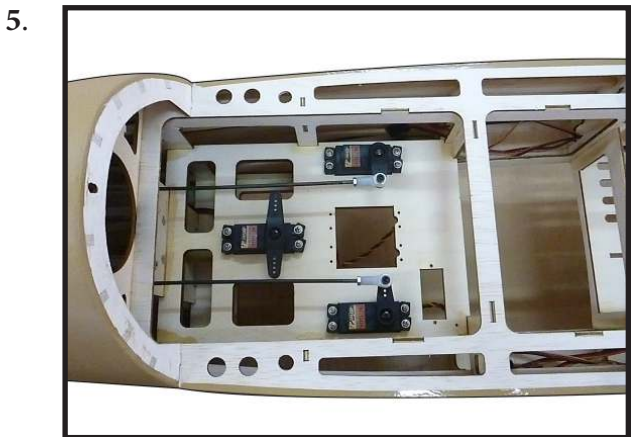
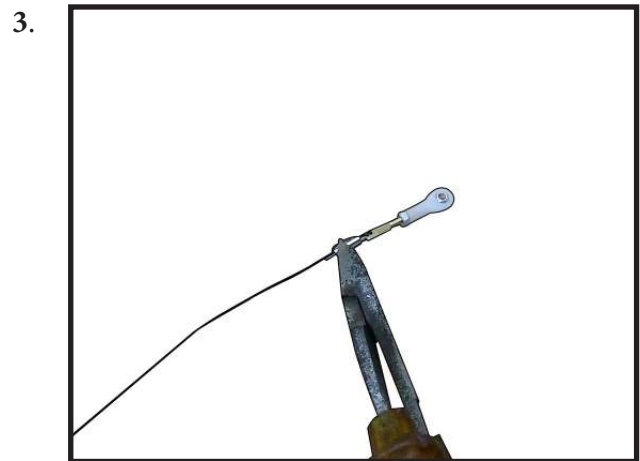
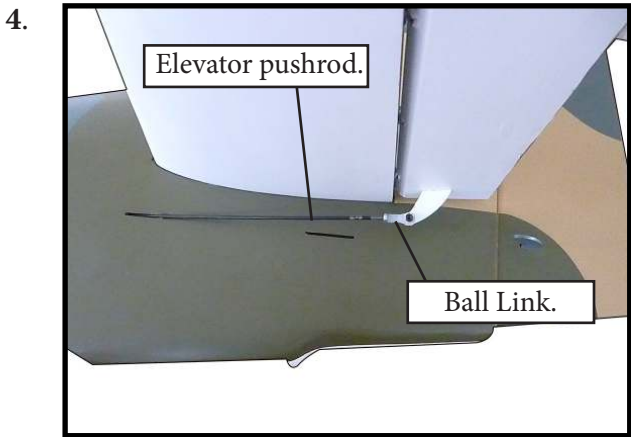
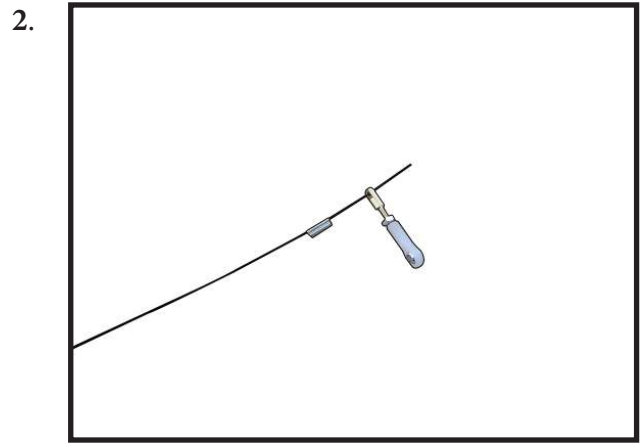
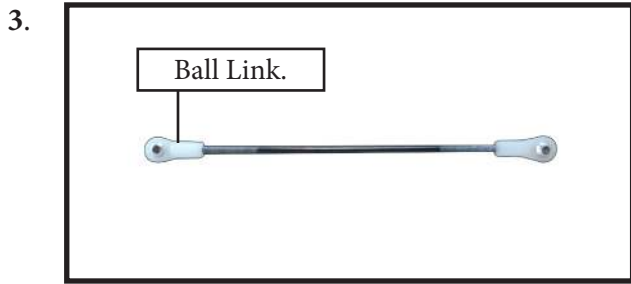

RUDDER CABLE INSTALLATION

Study images below to install pull-pull cable set.



6.

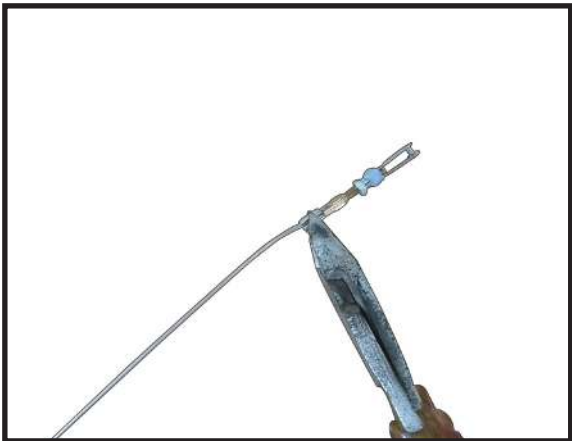

10.

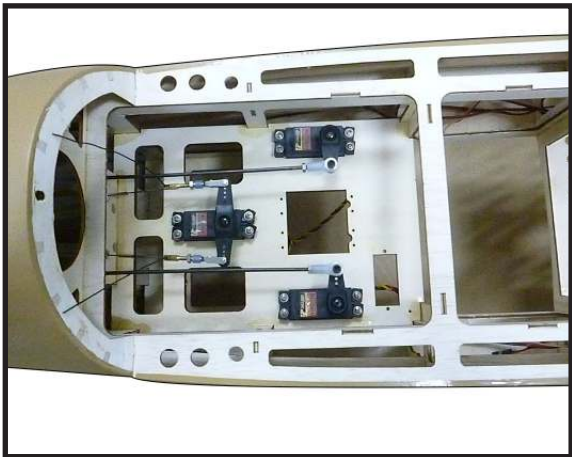

7.

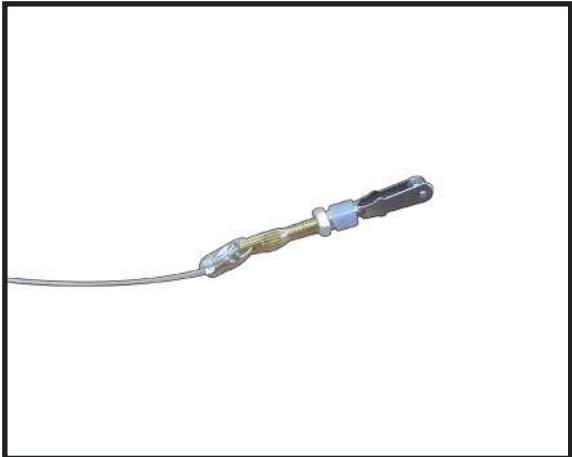

11.

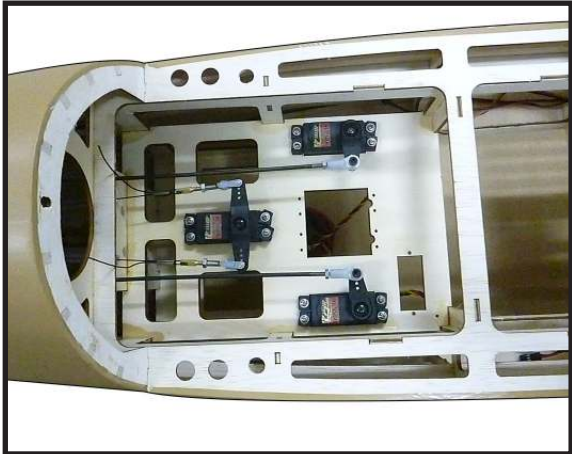

8.

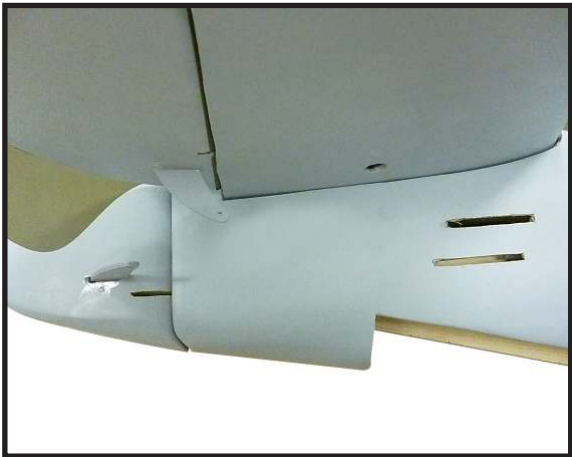

12.

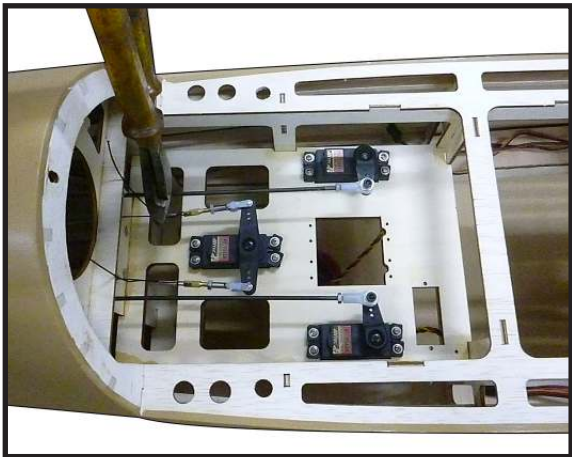

9.



13.

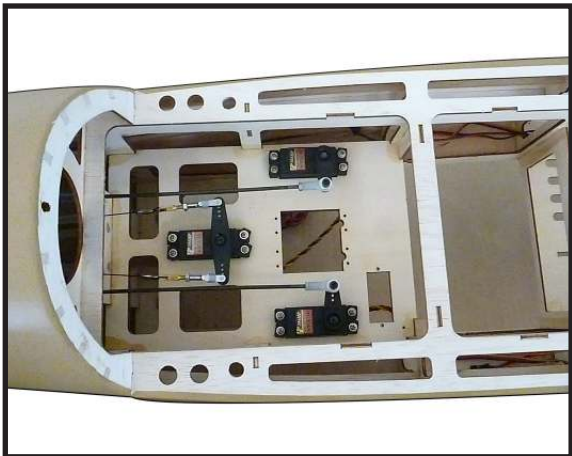

MOUNTING THE TAIL GEAR

Gather tail gear components as shown below for installation.

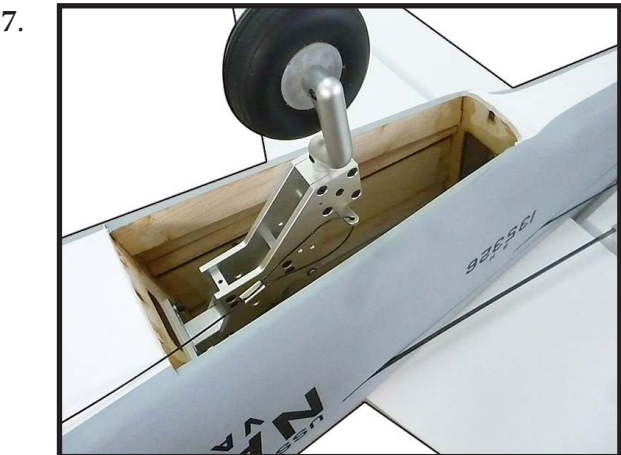
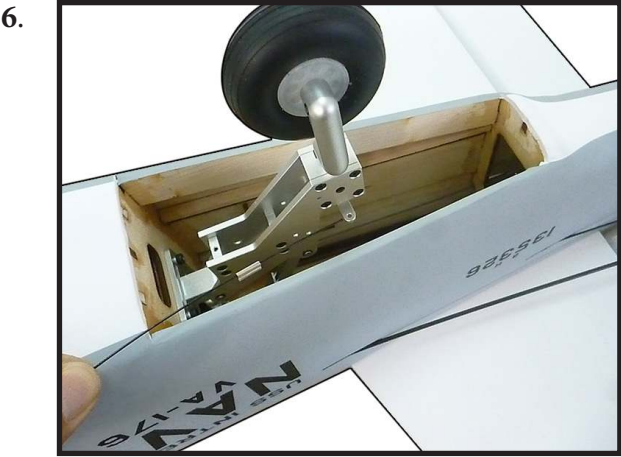
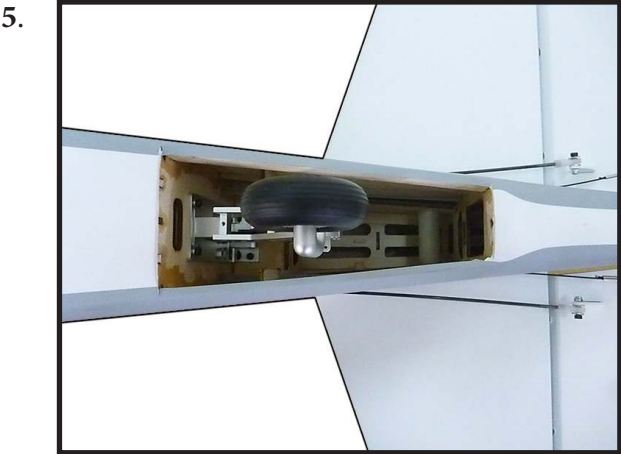
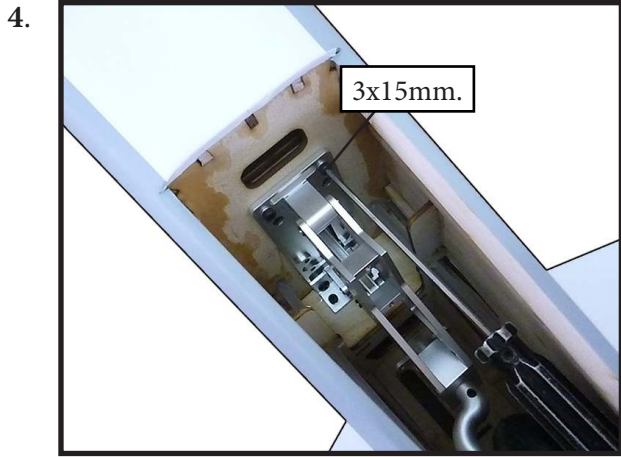
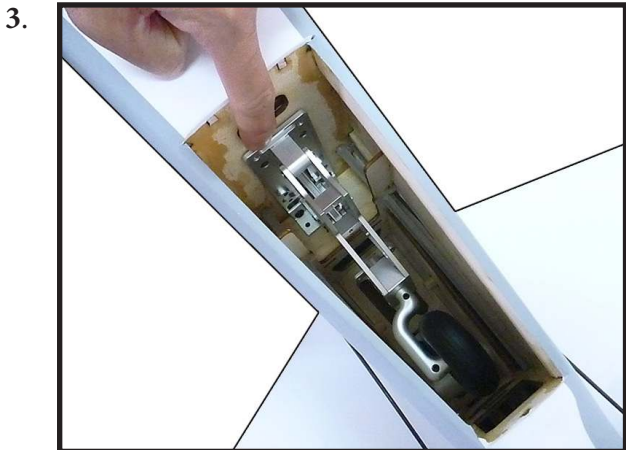
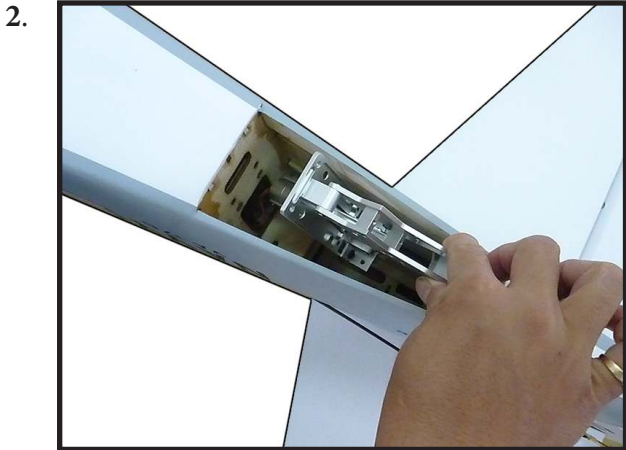

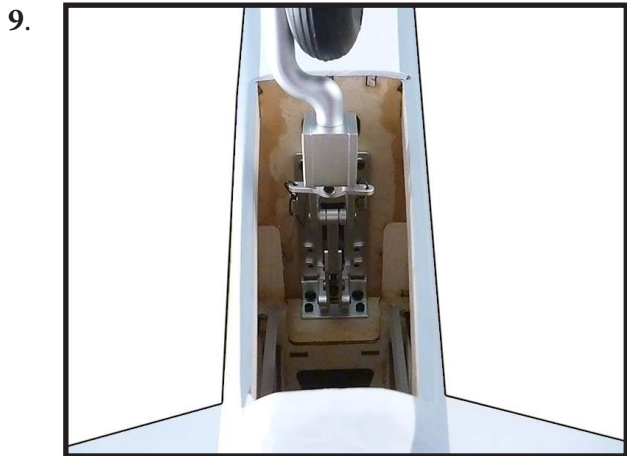
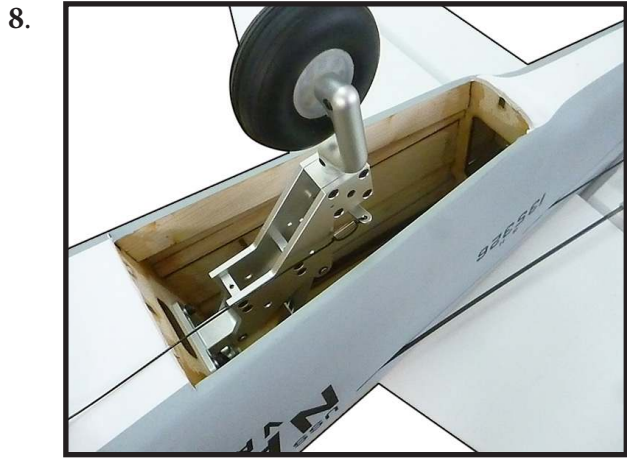

ATTACH WING TO FUSELAGE

Locate the (2) 6x60mm bolts and washers.

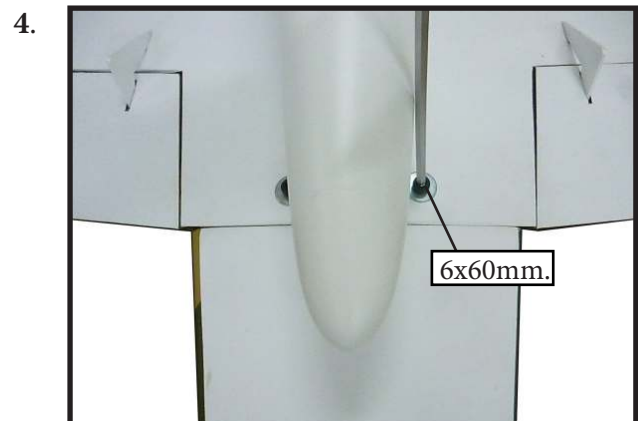
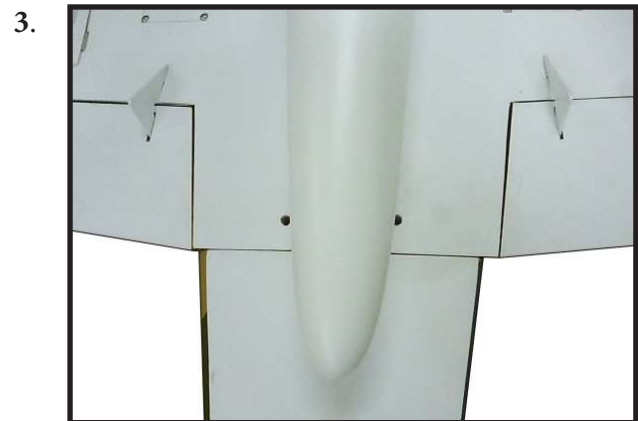
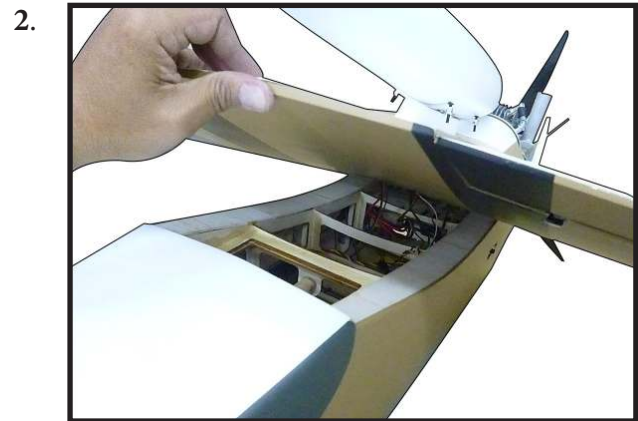
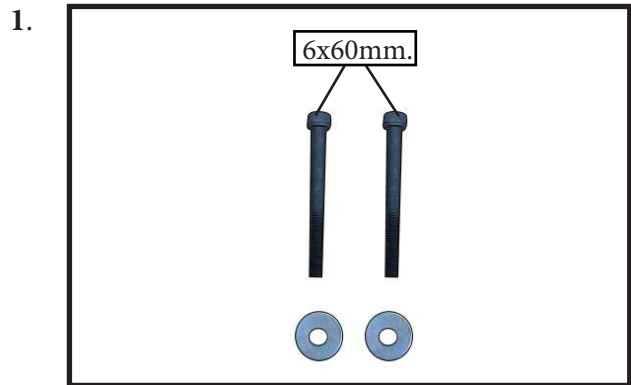

5.

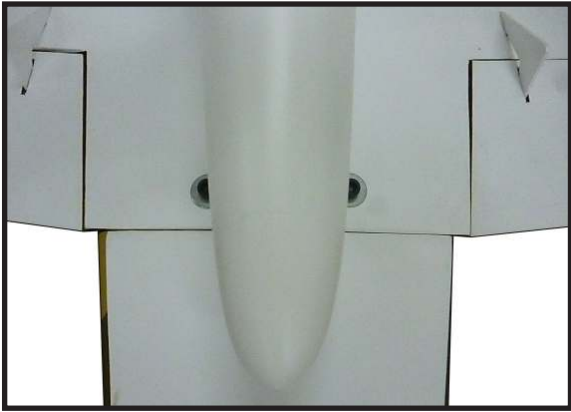

COCKPIT INSTALLATION

Locate all cockpit components as shown below.

1.



2.



3.



4.



5.

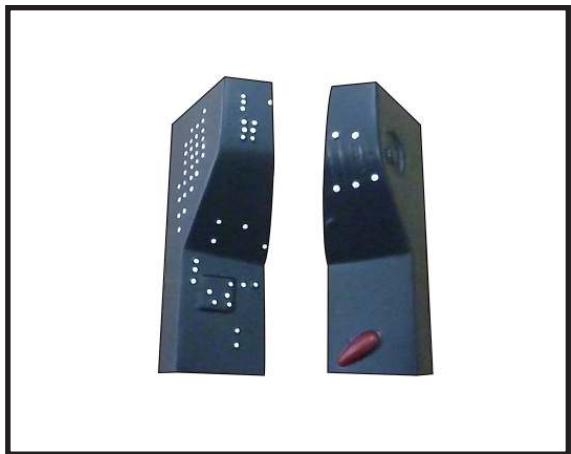

6.

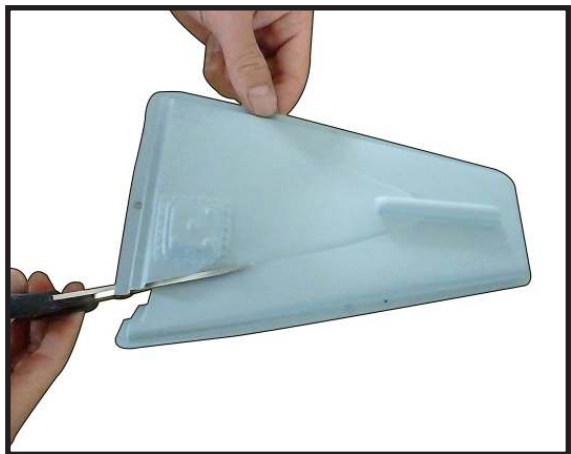

7.

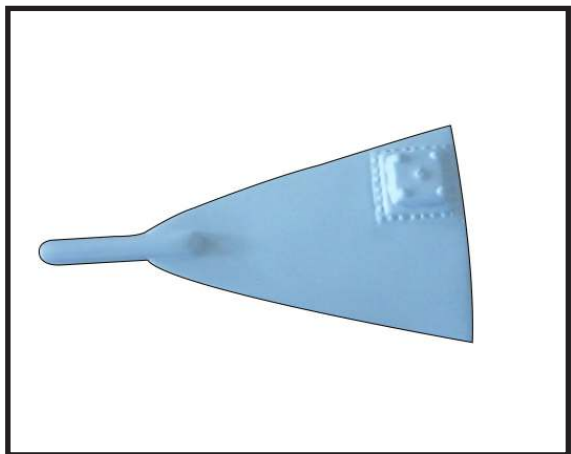

8.



12.

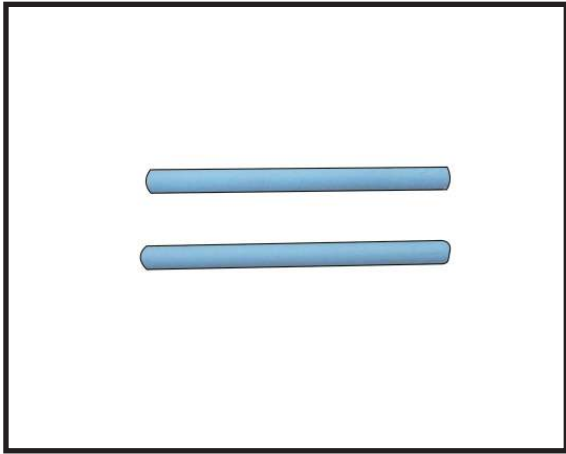

9.



13.



10.

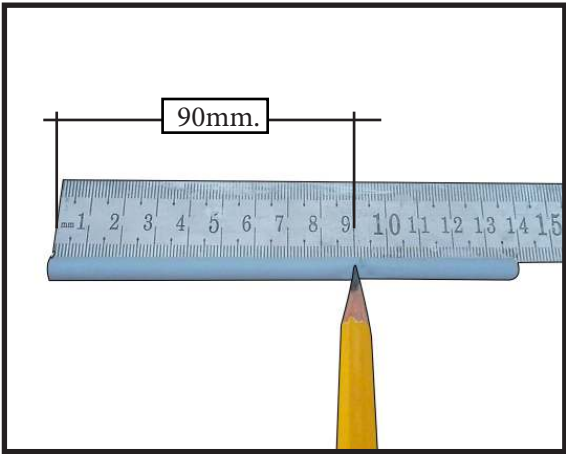

14.

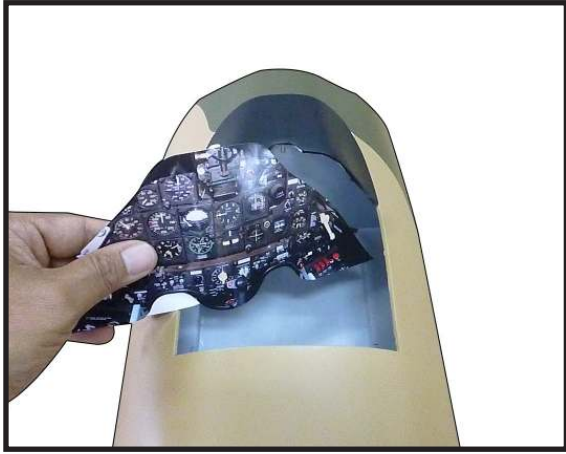

11.

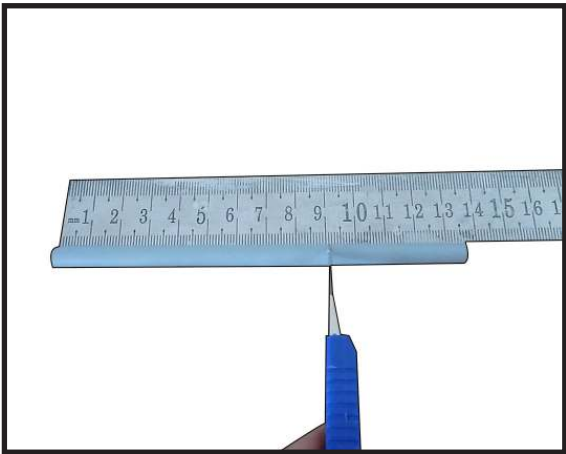

15.



16.



20.

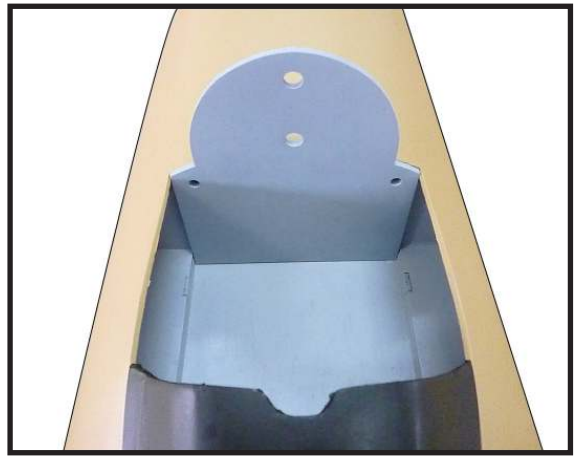

17.



21.

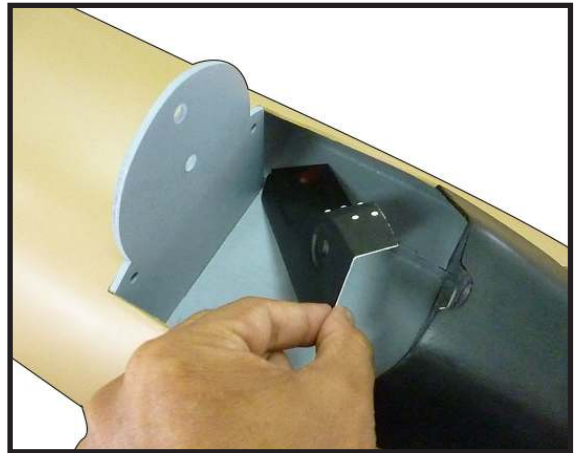

18.

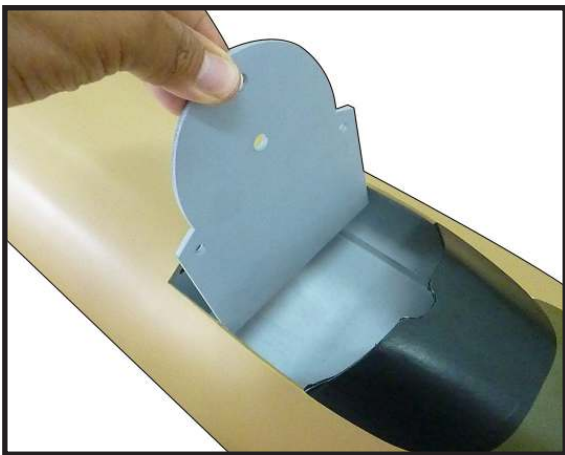

22.

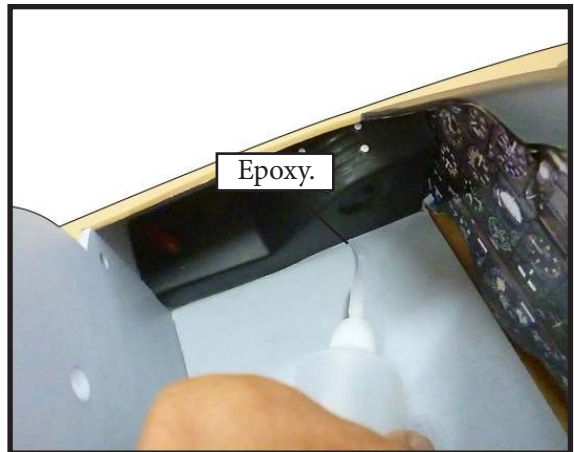

19.

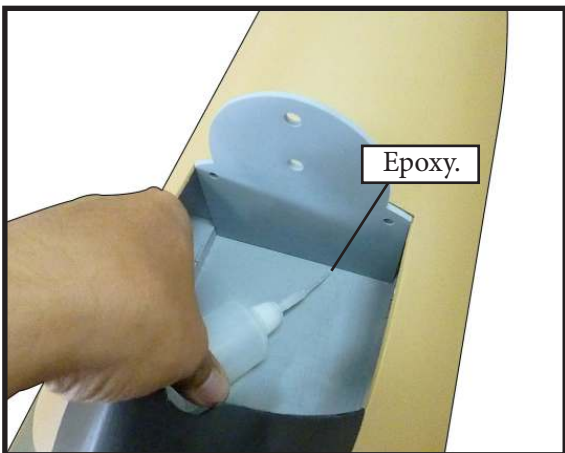

23.



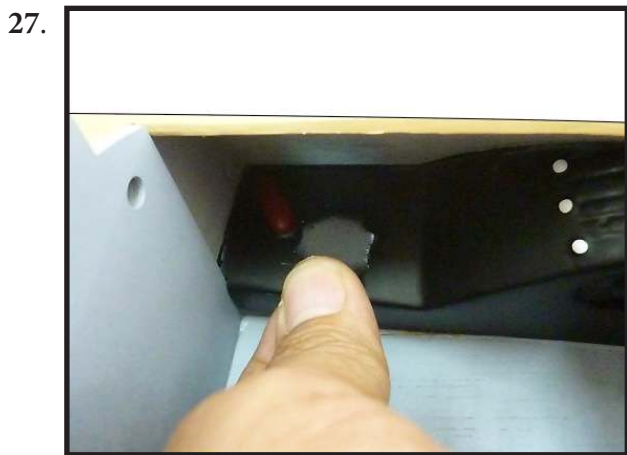
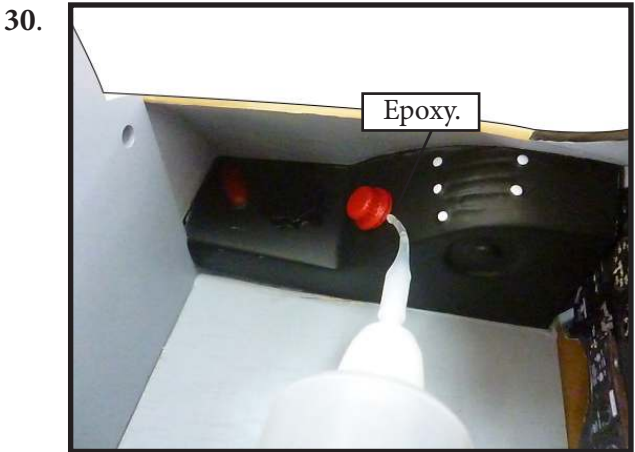
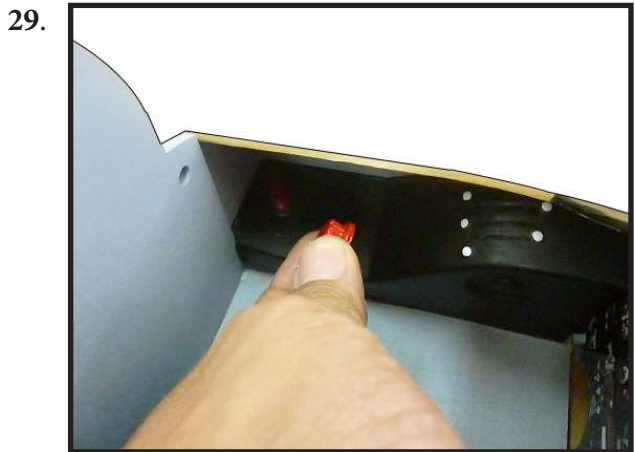
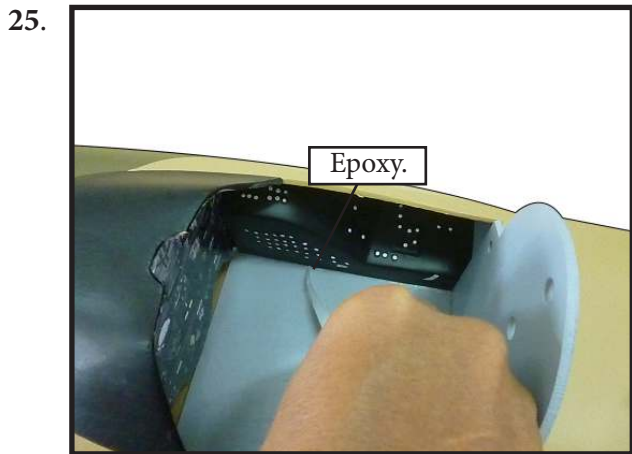
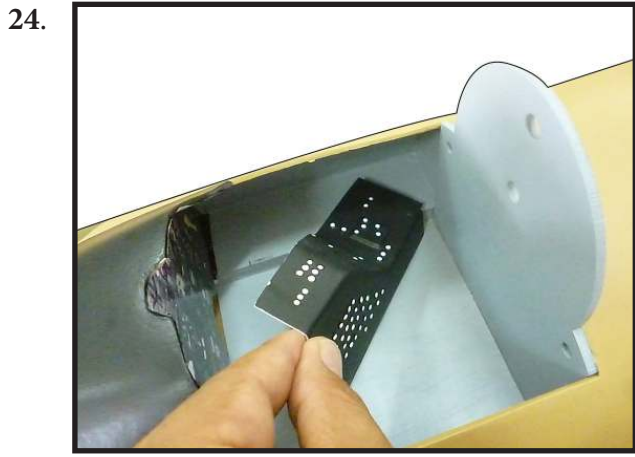

32.

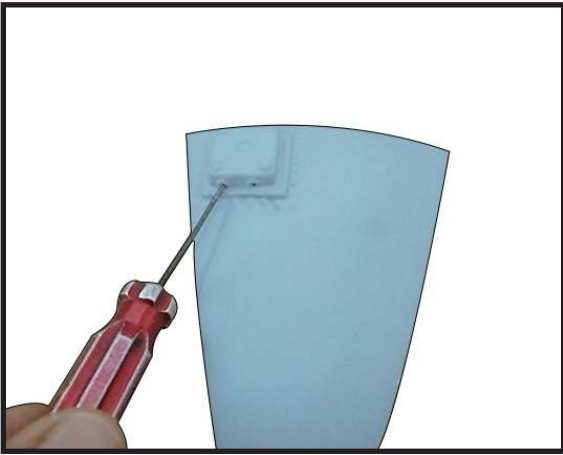

36.

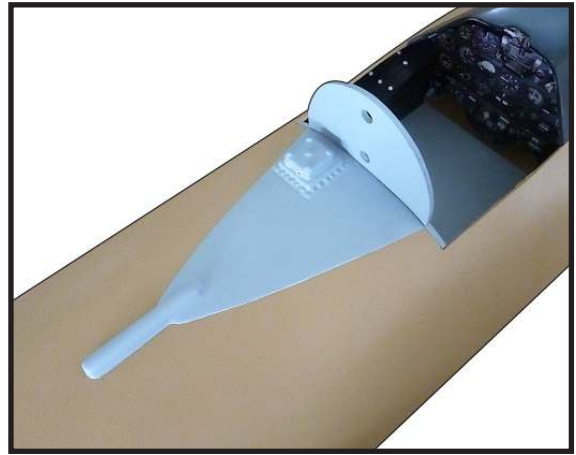

33.

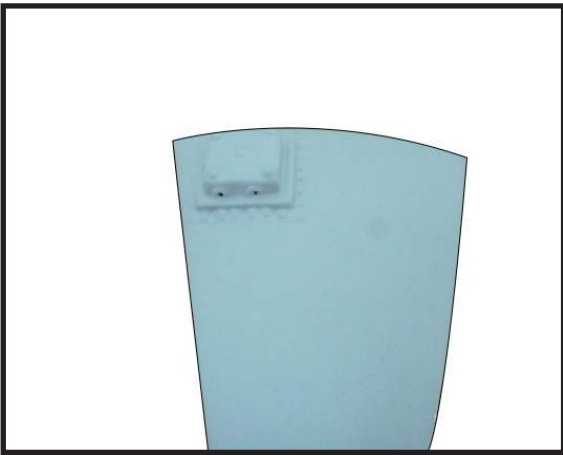

37.

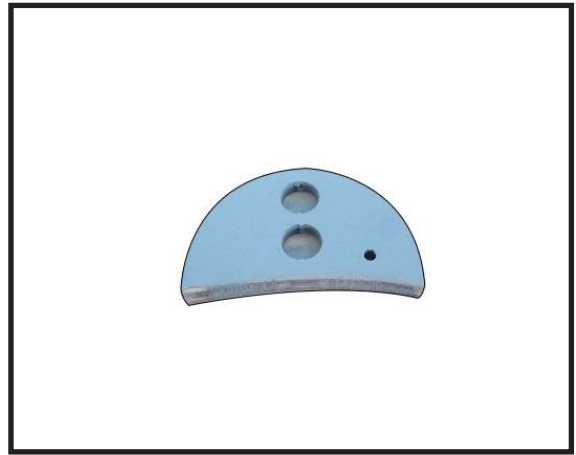

34.

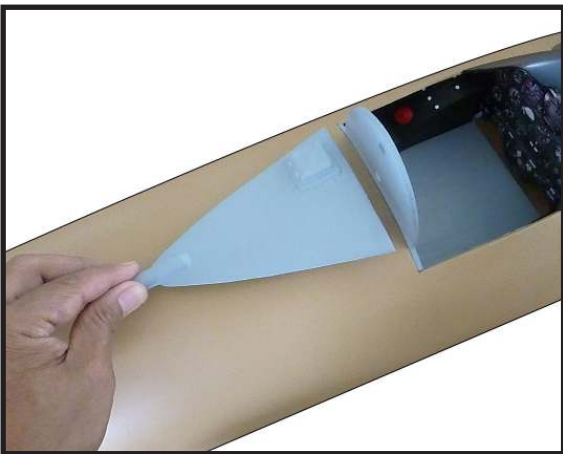

38.

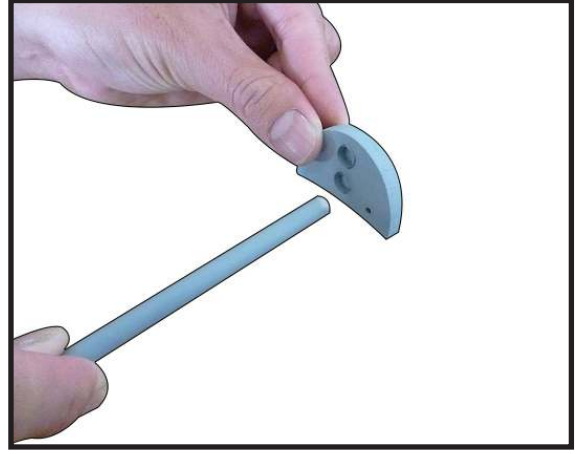

35.

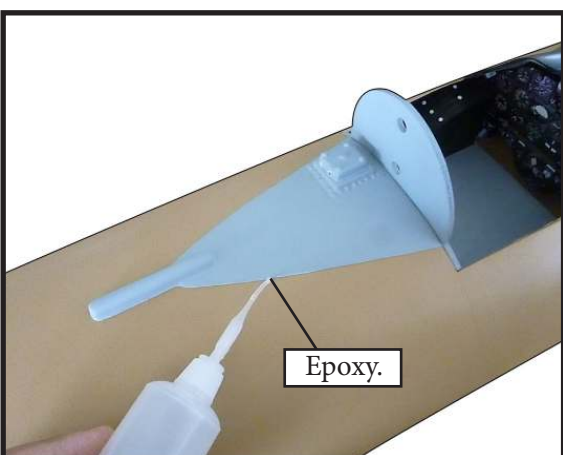

39.

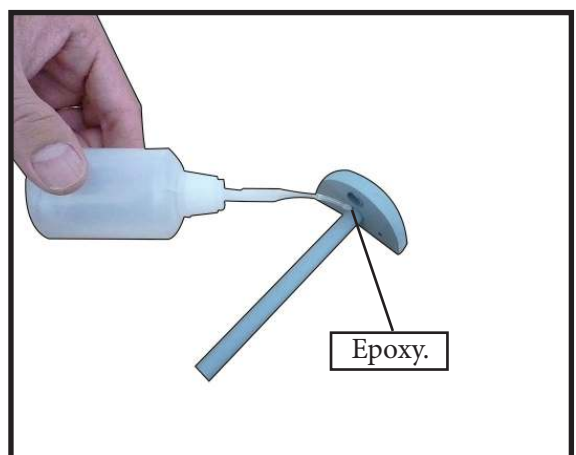

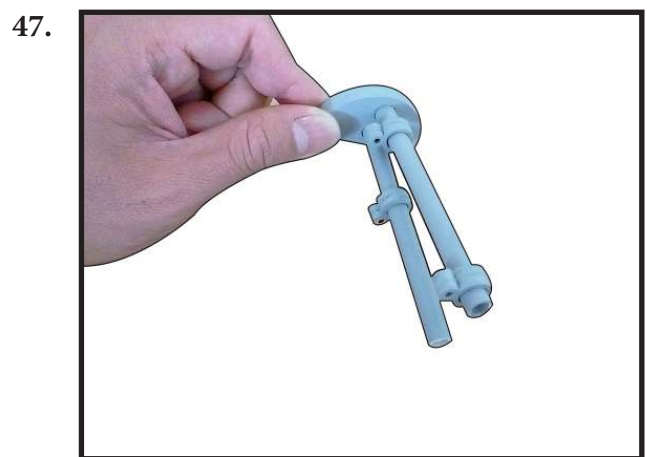
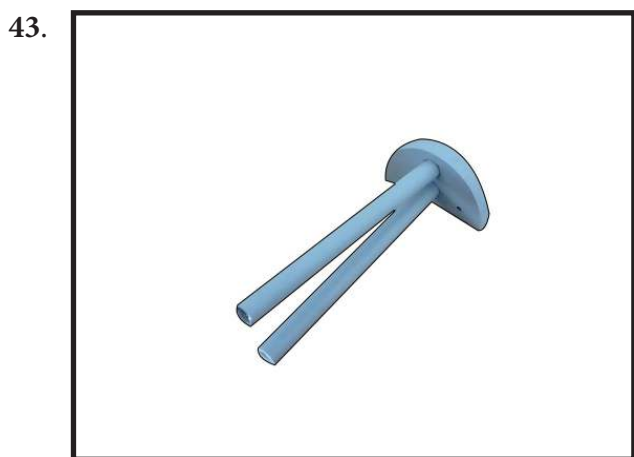
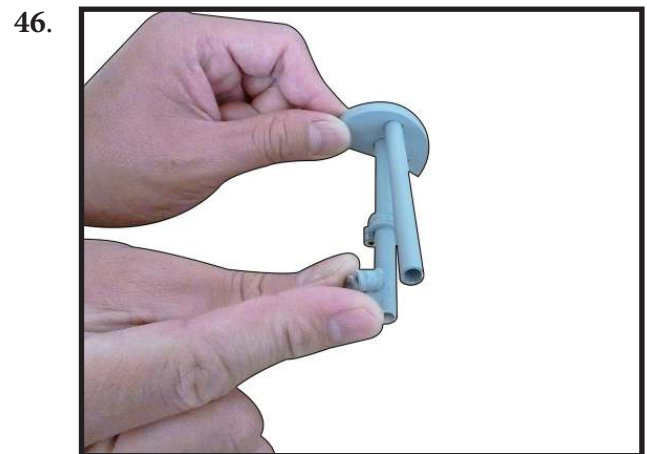
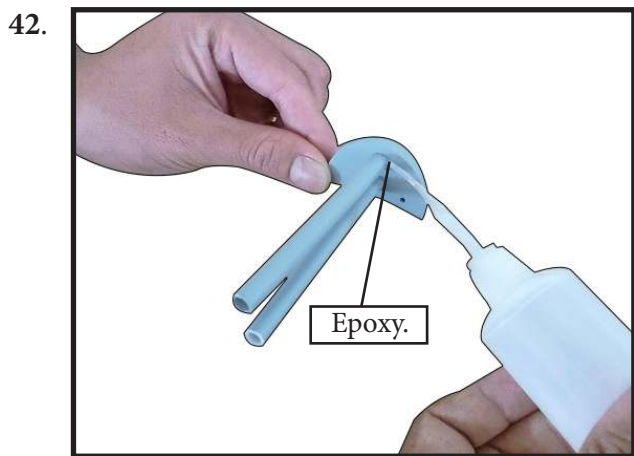
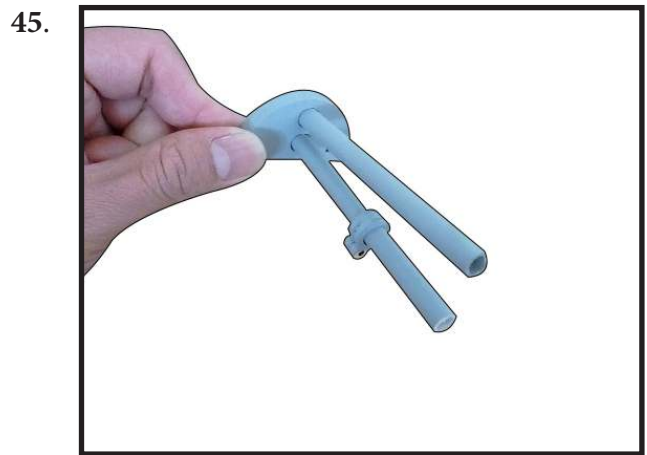
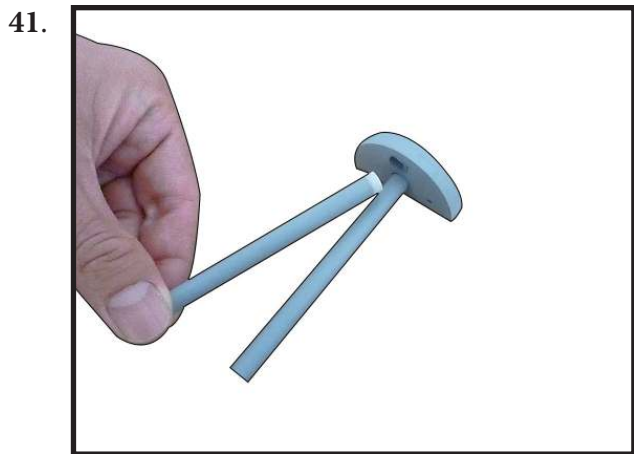
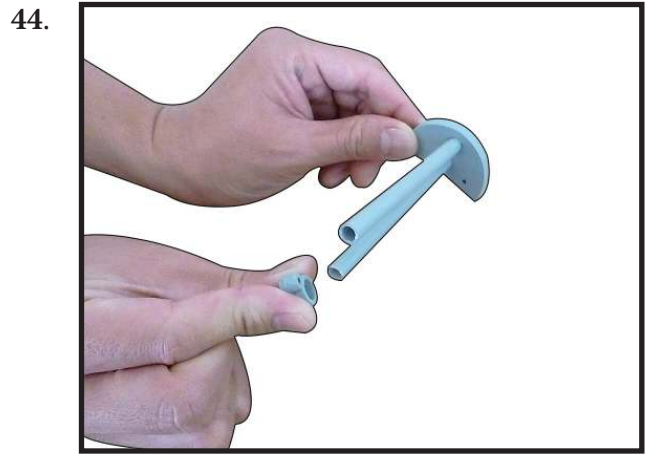
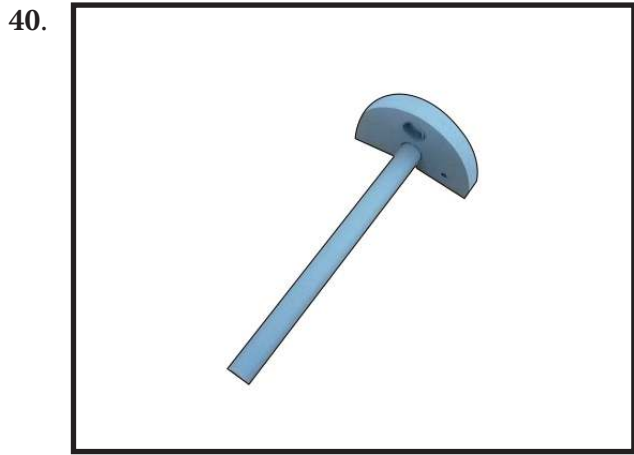

48.

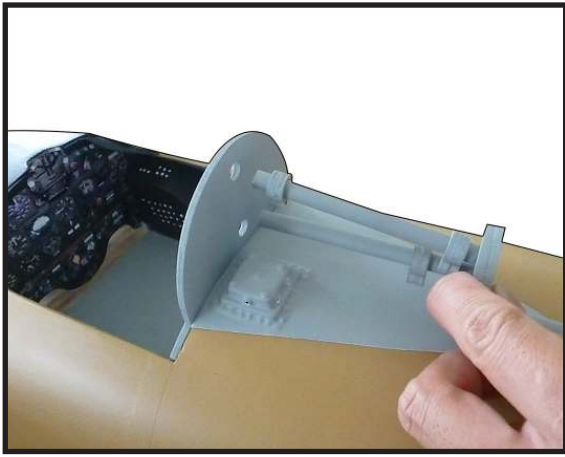

52.

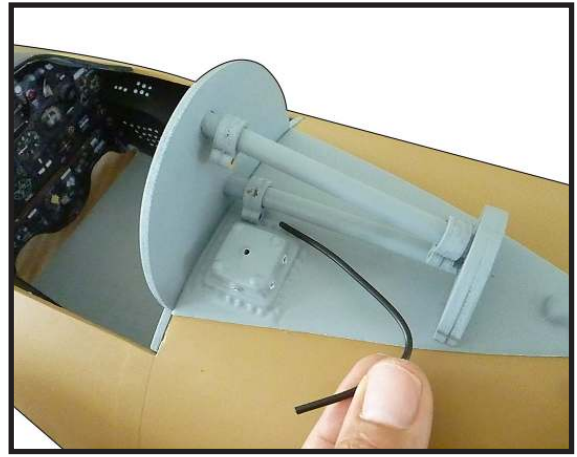

49.

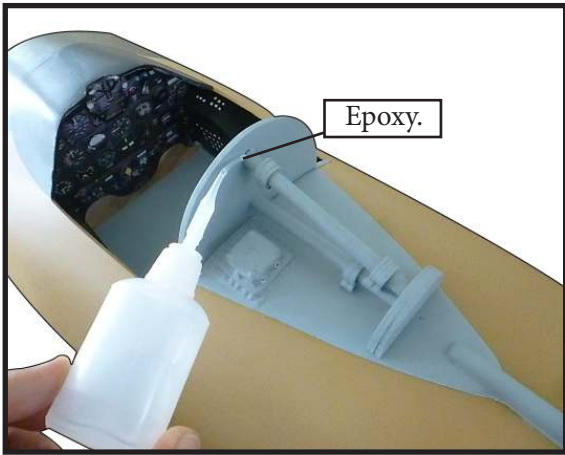

53.

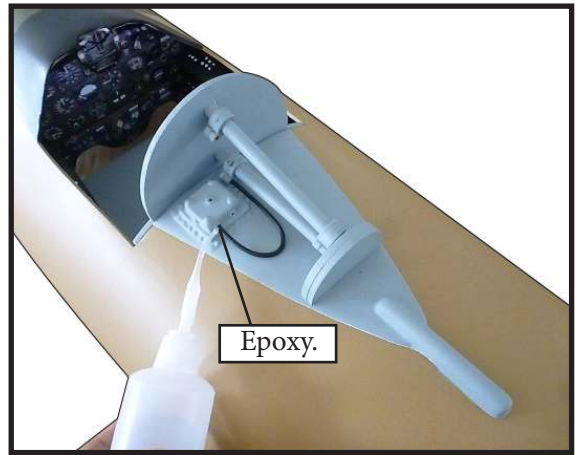

50.

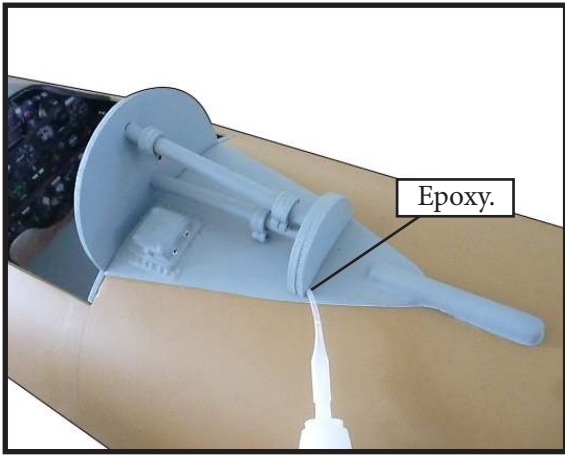

54.

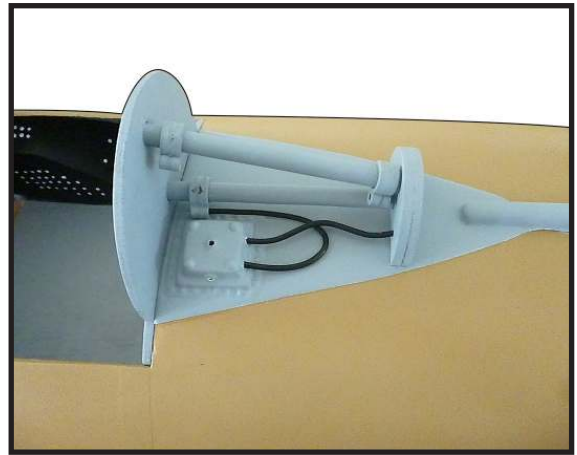

51.

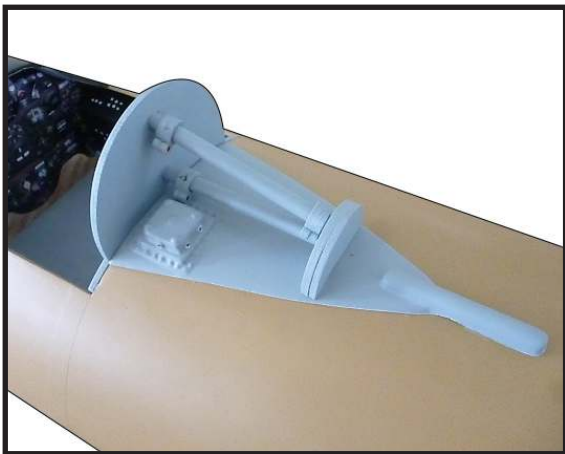

55.

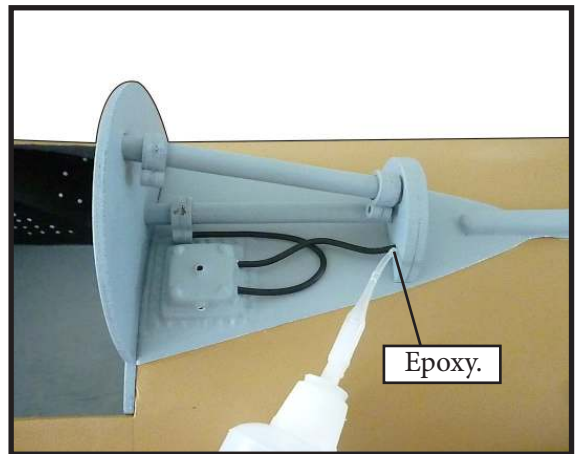

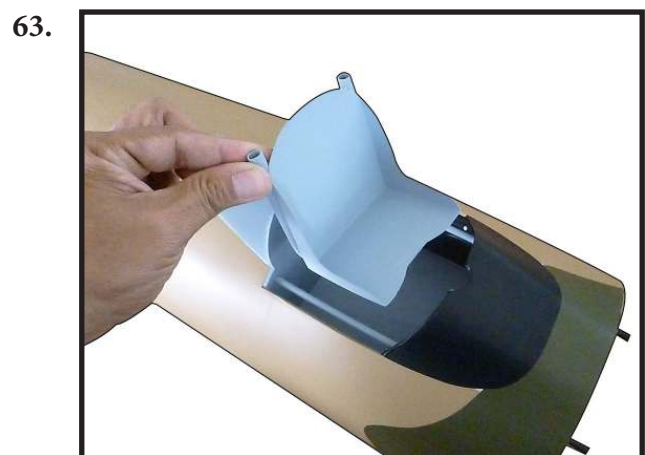
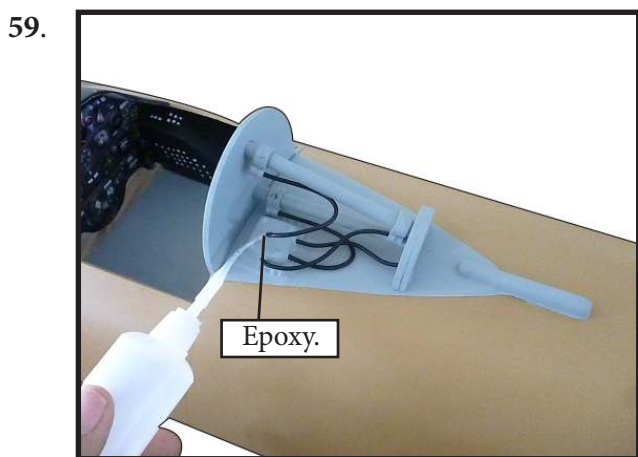
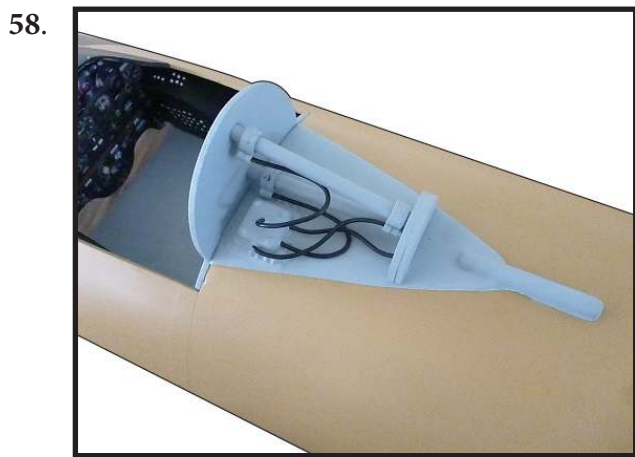
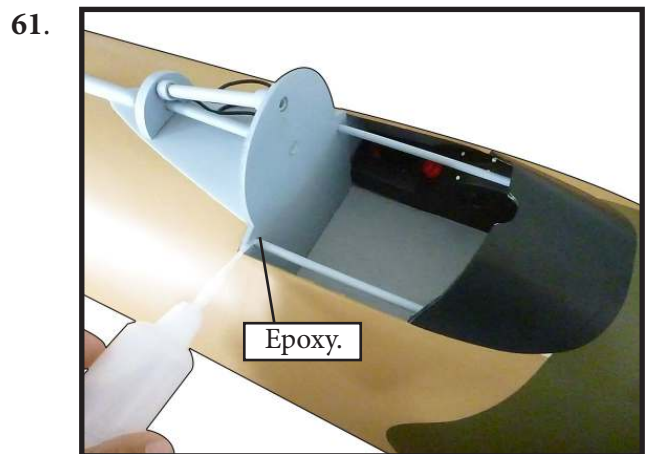
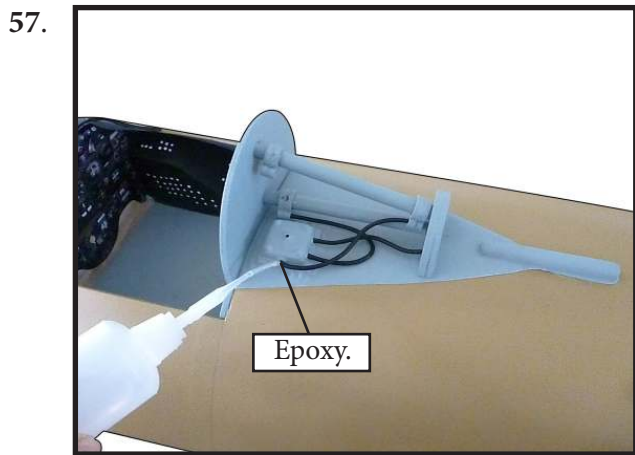
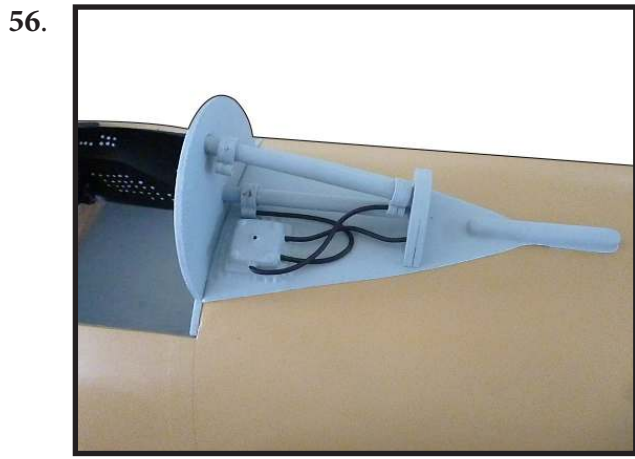

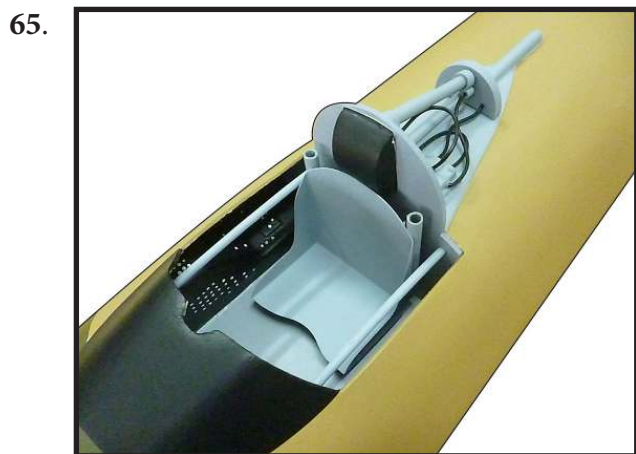
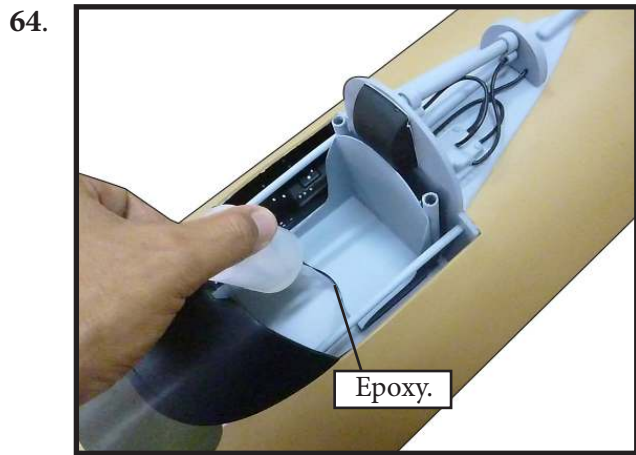

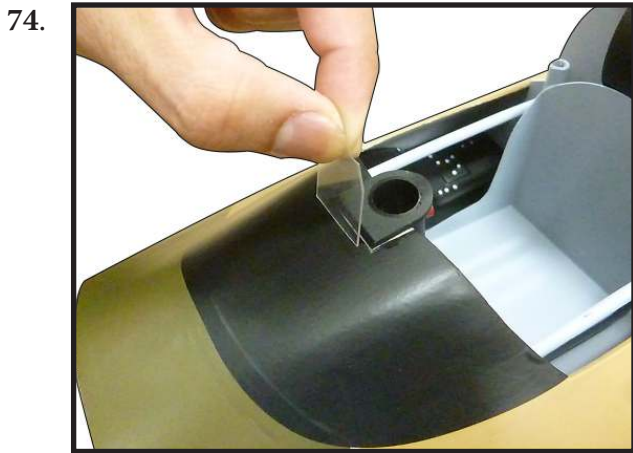
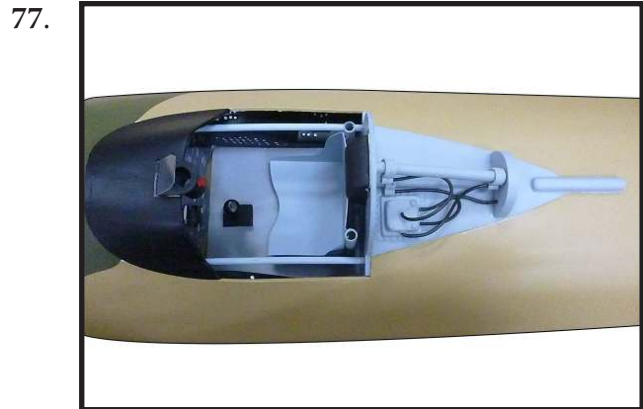
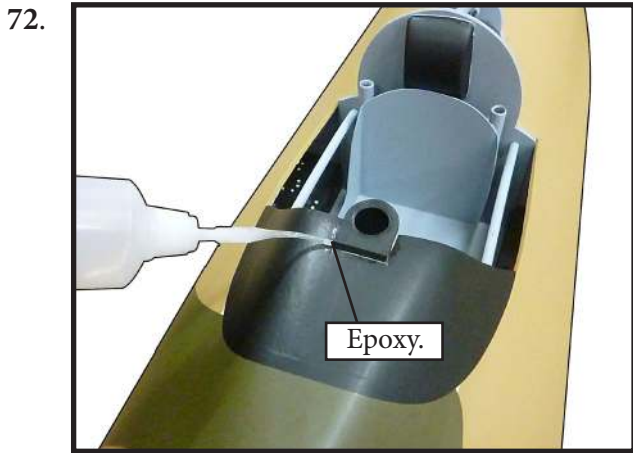

INSTALLING CANOPY

Trim and install as shown below.

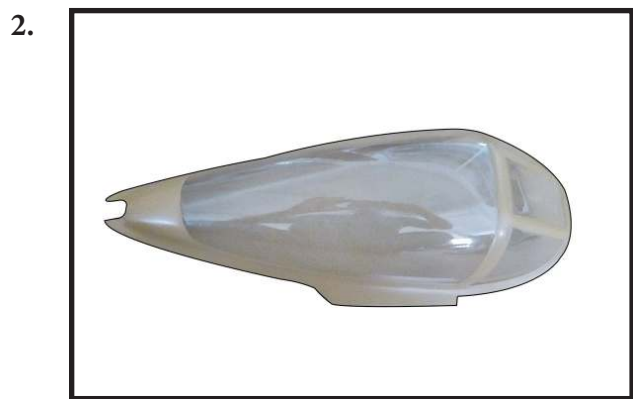
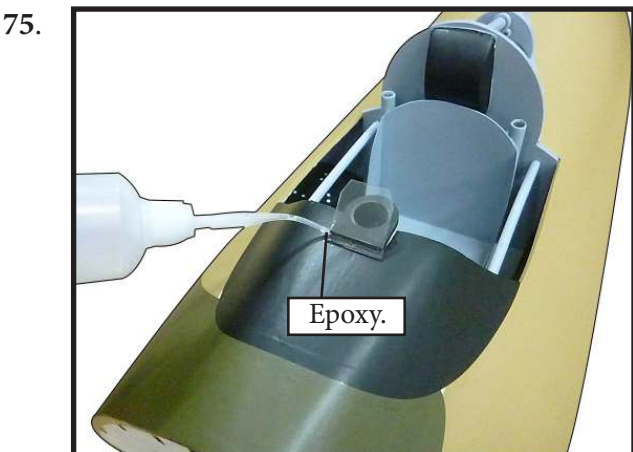

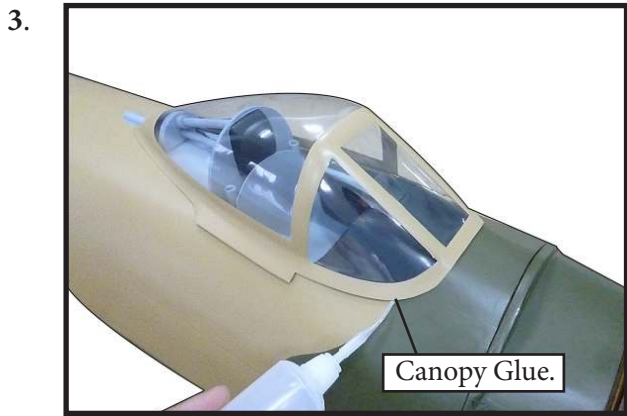

AIR INTAKE INSTALLATION

Study images below and then install intake.

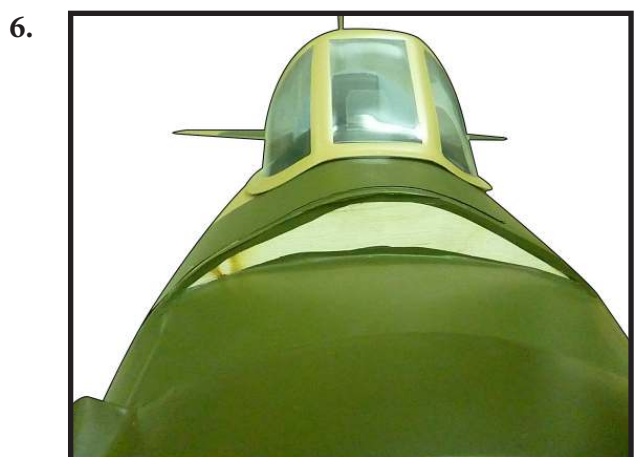
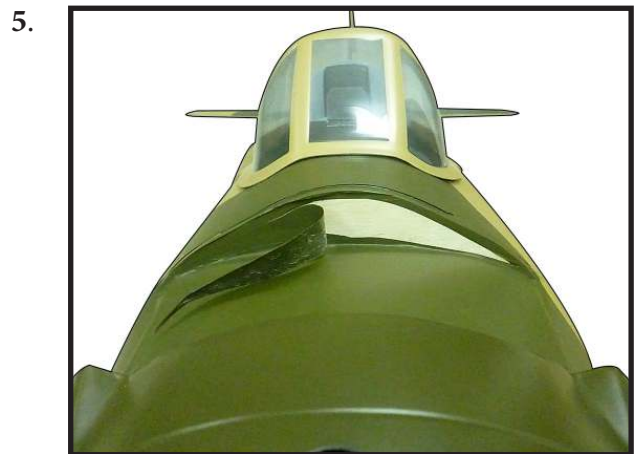
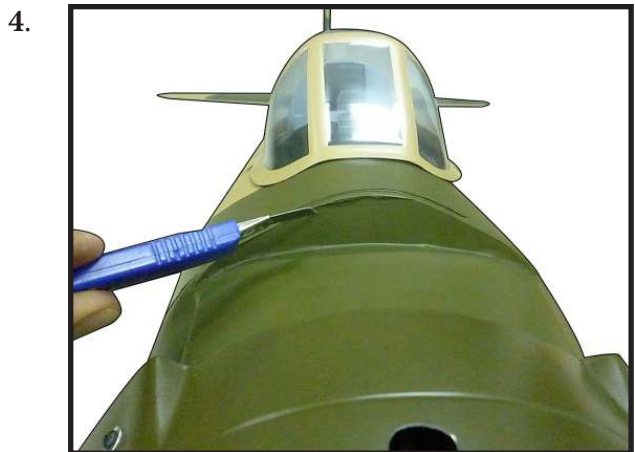
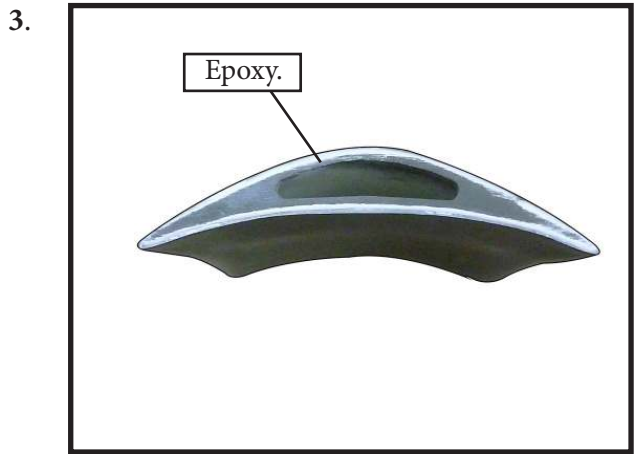
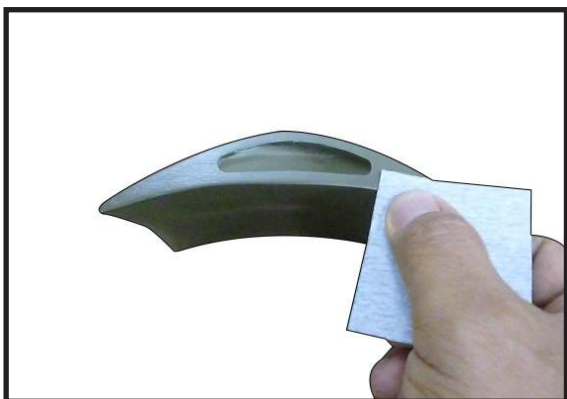

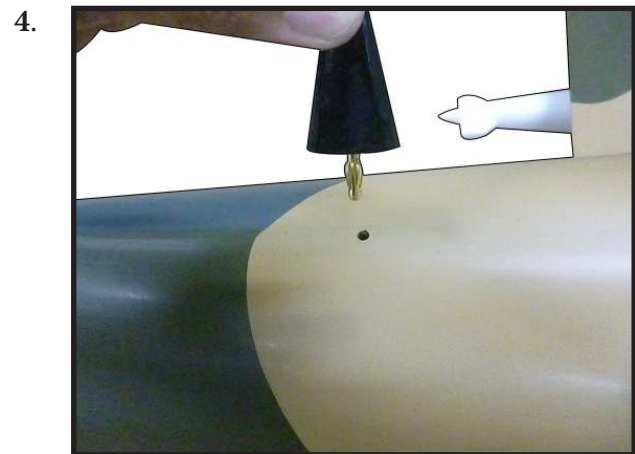
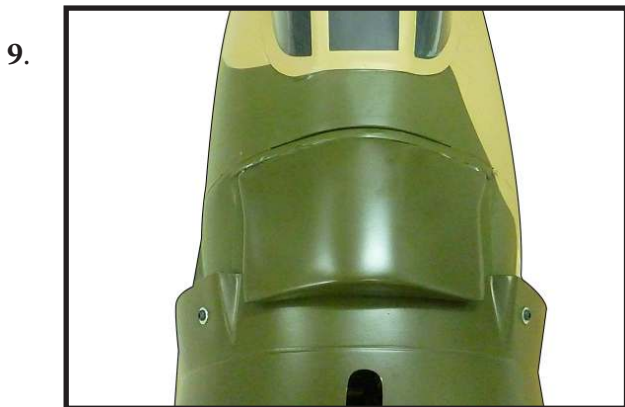
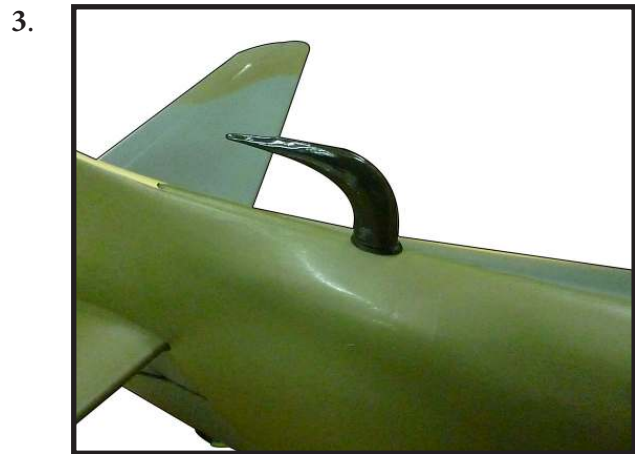
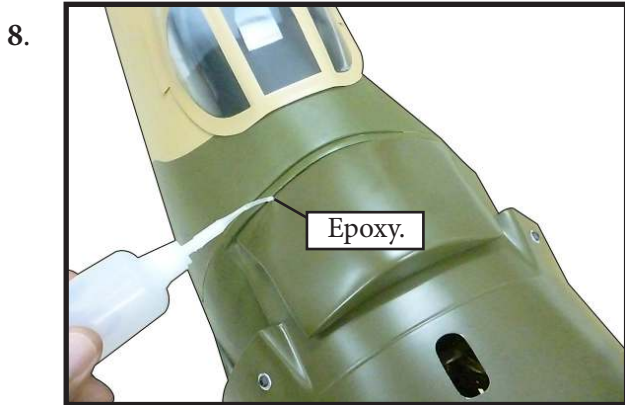
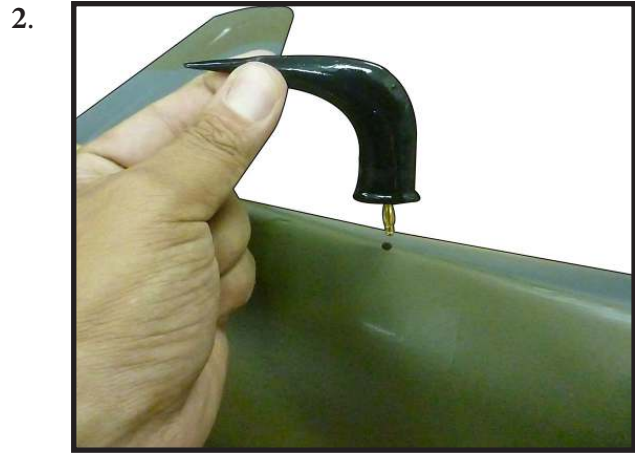

INSTALLING ANTENNAS

Antennas feature banana plugs for easy installation and removal.

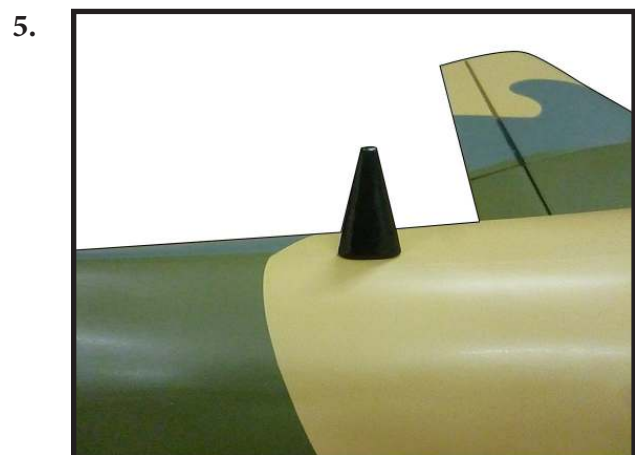

6.



INSTALL THE WING GUNS

Locate the 4 Gun as seen in images below.

1.



2.



3.

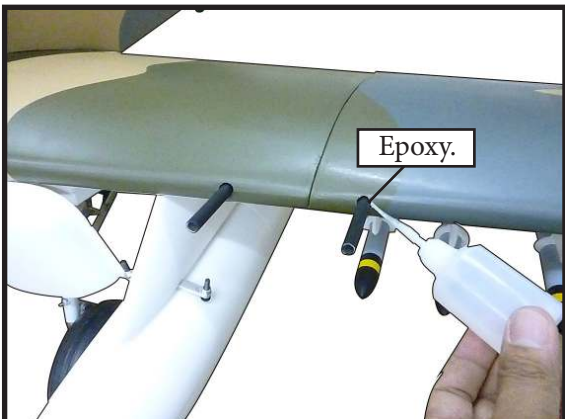

4.



APPLYING DECALS

Please use scissors and/or a hobby knife to cut the decals from the sheet. Please be certain the model is clean and free from oily fingerprints and dust. Position decal on the model where desired. You may use the photos on the box and/or online images to aid in their location and application.

If using custom decals, please follow manufacturers instructions to install those decals. Please be certain the model is clean and free from oily fingerprints and dust. Position decal on the model where desired, using images of appropriate artwork/photos to aid in their location.

BALANCING - DO NOT SKIP THIS !

It is **critical** that your airplane be balanced correctly. Improper balance will cause your plane to lose control and crash. THE CENTER OF GRAVITY IS LOCATED **125-145MM** BACK FROM THE LEADING EDGE OF THE WING AT THE WING ROOT.

Landing gear should be in the "up" retracted position when balancing.

Mount the wing to the fuselage. Place a piece of masking tape on the top of each wing 145mm back from the leading edge at the wing root.

With the model inverted, place your fingers on the masking tape and carefully lift the plane. This is the point at which your model should balance for your first flights. Later, you may wish to experiment by shifting the balance up to 10mm forward or back to change the flying characteristics. Moving the balance forward may improve the smoothness and arrow-like tracking, but it may then require more speed for take off and make it more difficult to slow down for landing. Moving the balance aft makes the model more agile with a lighter and snappier "feel". In any case, please start at the location we recommend.

* If possible, first attempt to balance the model by changing the position of the receiver battery and receiver. If you are unable to obtain good balance by doing so, then it will be necessary to add weight to the nose or tail to achieve the proper balance point.

With the wings attached to the fuselage, all parts of the model installed (ready to fly), and empty fuel tanks, hold the model at the marked balance point with the stabilizer level.

Lift the model. If the tail drops when you lift, the model is "tail heavy" and you must add weight* to the nose. If the nose drops, it is "nose heavy" and you must add weight* to the tail to balance.

1.

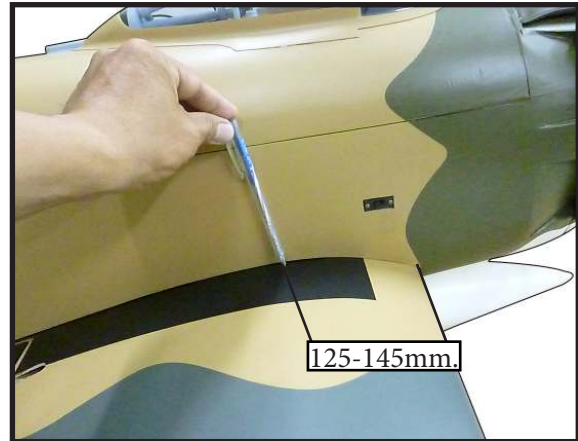
**CONTROL THROWS**

Ailerons:	Rudder:
High Rate :	High Rate :
Up : 20 mm	Right : 25 mm
Down : 20 mm	Left : 25 mm
Low Rate :	Low Rate :
Up : 15 mm	Right : 20 mm
Down : 15 mm	Left : 20 mm
Elevator:	Flap:
High Rate :	Mid : 50mm
Up : 20 mm	Full : 60mm
Down : 20 mm	
Low Rate :	
Up : 15 mm	
Down : 15 mm	

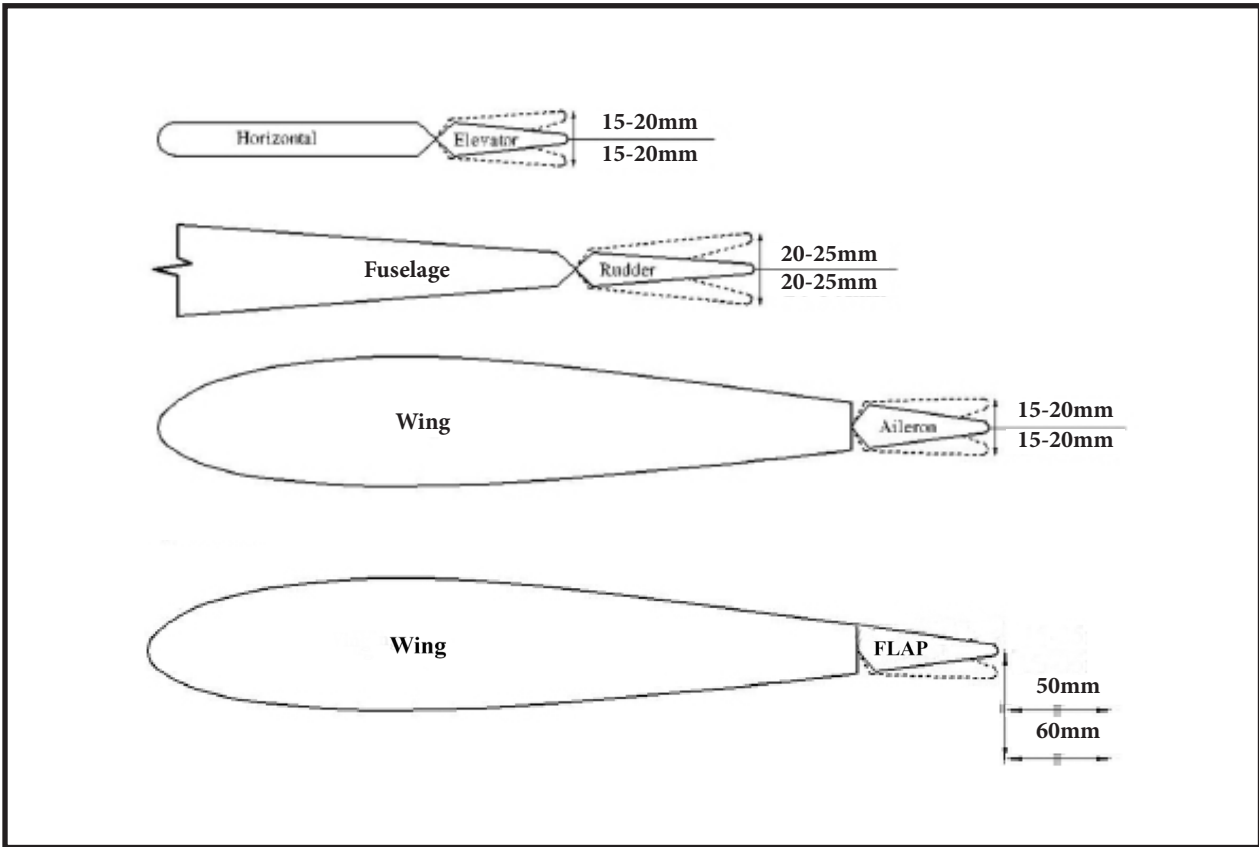

FLIGHT PREPARATION

Check the operation and direction of the elevator, rudder, ailerons and throttle.

- A) Plug in your radio system per the manufacturer's instructions and turn everything on.
- B) Check the elevator first. Pull back on the elevator stick. The elevator halves should move up. If they do not, flip the servo reversing switch on your transmitter to change the direction.
- C) Check the rudder. Looking from behind the airplane, move the rudder stick to the right. The rudder should move to the right. If it does not, flip the servo reversing switch on your transmitter to change the direction.
- D) Check the throttle. Moving the throttle stick forward should open the carburetor barrel. If it does not, flip the servo reversing switch on your transmitter to change the direction.
- E) From behind the airplane, look at the aileron on the right wing half. Move the aileron stick to the right. The right aileron should move up and the other aileron should move down. If it does not, flip the servo reversing switch on your transmitter to change the direction.

PREFLIGHT CHECK

- 1) Completely charge your transmitter and receiver batteries before your first day of flying.
- 2) Check every bolt and every glue joint in the **86" A-1 SKYRAIDER 35-60cc WARBLRD** to ensure that everything is tight and well bonded.
- 3) Double check the balance of the airplane. Do this with the fuel tank empty.
- 4) Check the control surfaces. All should move in the correct direction and not bind in any way.
- 5) If your radio transmitter is equipped with dual rate switches double check that they are on the low rate setting for your first few flights.
- 6) Check to ensure the control surfaces are moving the proper amount for both low and high rate settings.
- 7) Check the receiver antenna. It should be fully extended and not coiled up inside the fuselage.
- 8) Properly balance the propeller. An out of balance propeller will cause excessive vibration which could lead to engine and/or airframe failure.

*We wish you many safe and enjoyable flights
with your 86" A-1 SKYRAIDER 35-60cc WARBLRD. "KEEP 'EM FLYING"*

*If you have any queries, or are interested in our products,
please feel free to contact us*

Factory : 12/101A - Hamlet 4 - Le Van Khuong Street - Dong Thanh Ward -
Hoc Mon District - Ho Chi Minh City - Viet Nam.

Office : 62/8 Ngo Tat To Street - Ward 19 - Binh Thanh District - Ho Chi Minh
City - Viet Nam

Phone : 848 - 86622289 or 848- 36018777

Website : www.SeagullModels.com

Email : Sales@seagullmodels.com

Facebook : www.facebook.com/SeaGullModels.