

# Quick Start Instruction

快速入门指南

## SUPER RIDER

MAKE YOUR HEART RACING AND  
YOUR BLOOD BOILING ...



## SUPER RIDER

# 闪电骑士 SR5

1:4 SCALE RC DIRT BIKE  
1:4 遥控电动越野摩托车

# SKYRC

# SKYRC

All specifications and figures are subject to change without notice.

本公司有权在不通知的情况下变更产品设计，外观，性能及使用要求。



Manufactured by  
SKYRC TECHNOLOGY CO., LTD.  
天空创新科技(深圳)有限公司  
www.skyrc.com  
Printed in China 7504-0676-01

Before beginning running, please read these instructions thoroughly.  
在操作此产品前，请仔细阅读说明书





**TABLE OF CONTENTS 目录**

INTRODUCTION  
简介..... 01

SAFETY PRECAUTIONS  
安全提示..... 03

RUNNING IN WET CONDITIONS  
潮湿条件驱车..... 04

AFTER RUNNING IN WET CONDITIONS  
潮湿条件驱车后注意事项..... 04

FEATURE  
产品特点..... 04

MOTOR GEARING  
马达齿轮..... 04

SPECIFICATION  
参数..... 05

ILLUSTRATION OF MAIN PARTS  
产品主要部件图示..... 05

READY TO RUN PREPARATION  
跑前准备工作..... 06

EXPLODED VIEWS  
分解图..... 08

HELPFUL HINTS FOR ASSEMBLY  
安装提示..... 15

CHARGE PROCEDURES  
电池充电操作..... 16

OPTIONAL PARTS  
升级件..... 16

TROUBLE SHOOTING  
疑难解答..... 17

WARRANTY  
保修条款..... 17

 **IMPORTANT NOTICE**

SKYRC is unable to ensure that the user will follow the instructions supplied with the bike, nor can SKYRC control how the bike is assembled, operated and maintained. For this reason, SKYRC cannot be held responsibility for damage, loss, or injury caused by the use of materials different from what is indicated in the manual, or from the improper use of the product. From the moment the buyer begins the assembly progress, he is assuming the responsibility of any consequence resulting from misuse or assembly. If customer can't accept this, please return the product to the place of purchase. The returned item should be new, unused and with complete package.

**注意事项**

本公司无法保证用户完全遵照说明书指示操作，也不能确保客户后续能正确安装/改装、恰当操作及妥善保养。因此，本公司不承担任何由于以下情况造成的破损、损失及人身伤害的责任：

1. 用户使用与说明书描述不符的材料或者配件；
2. 用户操作或者使用不当。

从客户开始安装摩托车的那一刻起，客户将自行承担由于使用不当造成的任何后果。如果客户不能接受此条款，请将摩托车退回购买处。注意，退回的摩托车必须全新，未使用，且包装完好。

**INTRODUCTION 简介**

Congratulations on your choice of the SkyRC Super Rider SR5. This kit is a high performance RC vehicle with electronic stabilizing system and adjustable gyro effect control board. Please carefully follow the instruction manual during assembly and pay attention to the warnings.

SKYRC Super Rider SR5 is a fully ready-to-run 1/4 dirt motocross. All electronics and other components are installed in the factory. The users only need to install the battery, and then it is ready to run. It is very stable even at very low speed. What's more, it is also able to do quick brake and jump in every different terrain and can do the off-road function in a superior way.

The point users concern most is the stability of the motocross. This newly-developed Super Rider SR5 features a revolutionary stability technology ESS (Electronic Stability System). This system consists of a gyro effect governor and an electronic gyro in rear wheel which makes the bike super stable when running. The users can adjust the RPM of the electronic gyro according to his request. There are 4 kinds of RPM that can be selected by user, 8000RPM, 10000RPM, 11000RPM and 12000RPM. The beginners can choose 12000RPM as the gyro effect is strong at this speed and the motocross will be more stable. When the users are familiar with the operation, he can choose lower RPM and the sensitivity of the motocross will be higher. Besides that, the oil shock absorbers in both front and rear wheel also make the SR5 much more stable than others.

Power is everything in motocross, and the SR5 comes with Toro 540 class 3200KV brushless motor and Leopard 60A ESC V2. The motor and ESC are all assemble well in the factory and the users only need to connect a 6-8S NiMH battery or 2-3S LiPo battery to the motocross(6S NiMH is included in the package), it will be ready to run. The battery case is located at the bottom of the motocross, it is simple and easy to take off the bolt, open the case, put the battery into it and lock the battery case. When the power system works, it will burn out monster power. Even the motocross fall down, the monster power can make it stand up by itself. Users can run it wherever he feels like and however fast he wants. Up hills and flying over

非常感谢您购买由天空创新科技（深圳）有限公司研发生产的闪电骑士SR5。这是一款高性能的电动遥控摩托车，配有电子平衡装置及可调节的陀螺仪控制装置。安装时，请仔细阅读说明书及各项警告。

闪电骑士SR5是一款1/4的遥控越野摩托车。所有的电子零件及其他配件在工厂已经安装好。用户只需装上遥控器及摩托车电池，就可以尽情操控摩托车了。此款摩托车的稳定性能非常好，即使是低速运行。在不同的场地，摩托车都能随时刹车跳跃，在泥泞道路上能发挥出越野性能。

对于大多数用户来说，最关心的问题就是摩托车的稳定性。这款最新研发的闪电骑士SR5运用了开创性的ESS电子平衡系统。此系统由陀螺效应控制板和后轮内的电子陀螺部件构成，可以提供超级稳定的驾驶感觉。用户可以根据自己的需求，调节电子陀螺仪的转速，有4种转速可供调节，8000RPM, 10000RPM, 11000RPM和12000RPM。初学者可以选择12000的电子陀螺转速，此时陀螺效应非常强，稳定性好，摩托车可以超低速前进。当用户熟悉操作后，可选择稍低的电子陀螺仪转速，此时摩托车的操作灵敏性增强。除此之外，前轮及后轮的油压减震系统也使闪电骑士SR5比市场上其他的摩托车稳定。

对于任何一款遥控模型产品，最重要的莫过于动力。闪电骑士SR5使用540级3200KV的无刷马达以及豹子二代60A的无刷电子调速器。马达及电子调速器在工厂已经安装完成并测试完成，用户只需装上6-8节镍氢电池或2-3节的锂聚合物电池（包装内含一块6节镍氢电池），摩托车就可以奔跑了。电池的安装非常简单，只需将电池盒上插销取下，放入电池，再装上插销即可。通电之后，闪电骑士将爆发出巨大的能量。即使摩托车在运行过程中倒下了，仍能依靠自身强大的动力站立起来继续奔跑。用户可以在任何地方以任何速度奔跑。爬山，飞跃，跳跃，在草坪，灰尘地，甚至很多沙子的地面，摩托车都能疾驰而过。直行/突转都在掌控之中。

铝合金车架加上金属链条让闪电骑士SR5越野摩托车非常的坚固耐用。配置的遥控器为2.4G，用

jumps or traveling on gravel and grass, dirt or pavement. Users can scream down straight away and corner with confidence.

The anodized aluminum chassis and metal chain driver make the motocross strong and durable.

Generally speaking, SKYRC Super Rider SR5 is a super stable motocross. With unique ESS technology, creative design and delicate workmanship, we believe you will have a totally different feeling when riding.

户可以在崎岖的地方自行享受飞驰的乐趣，也能在竞赛场地和其他玩家一决高下。

总之，闪电骑士SR5越野摩托车是一款超级稳定的摩托车，因其独创的ESS电子平衡系统，极富创意的设计以及精细的做工，我们相信将给用户提供全新的驾驶体验。

**ESS**  
Technology

## ELECTRONIC STABILIZING SYSTEM 电子平衡系统

Innovative Electronic Stability System (ESS) built into the rear wheel incorporates a powerful brushless motor and flying wheel which will provide gyro effect for optimal stability. Individual RPM (Rotations Per Minute) setting on the flying wheel can be selected through Gyro Effect Governor Board. High RPM provides optimal stability but less cornering and low RPM provides more maneuverability but less stability.

天空创新科技(深圳)有限公司隆重推出1:4越野摩托车-闪电骑士SR5，本车采用先进独创的电子平衡系统 (Electronic Stability System)，此系统由陀螺效应控制板和后轮内的电子陀螺部件组成。此系统提供超级稳定的驾驶感觉，并可根据使用者的需求进行调节，初学者可以使用较强的陀螺效应，使车身更加稳定，熟练驾驶后可以降低陀螺效应，提高转弯操控的灵活性。



## SAFETY PRECAUTIONS 安全提示

1. Keep away from moving parts to avoid injury of your fingers and hands.
  2. Do not operate this model close to people. Make sure the spectators are at a safe distance behind the operator.
  3. Do not use this model in the place where is not suitable to play, such as public roads, crowded places, near an airport or wherever the use of radio-controlled models is forbidden.
  4. Make sure to read the battery and charger instruction before charging and using the battery.
  5. When charging battery, please make sure there is someone aside. If the battery or charger becomes hot, disconnect the battery from charger immediately! Fail to do so may cause damage to battery, charger, property loss, even body harm.
  6. Do not cover the air intake holes on the charger which may cause overheat of the charger.
  7. Don't allow moisture, debris, water or other material get into the ESC and other electronics which may cause short circuit or other damages.
  8. Turn the transmitter ON before start and OFF after finish.
  9. Turn on the ESC after the transmitter is ON and turn off it before the transmitter is OFF.
  10. Make sure the motor and ESC has cooled down before next run.
  11. Do not operate with the low voltage batteries. It may cause the bike out of control or damage of the battery.
  12. Disconnect battery with the vehicle if you do not use it.
  13. This product is not a toy.
  14. Keep this product and all the relevant components away from children younger than 3 years old as the small components can be a choking / swallowing hazard!
  15. This is a high performance product and it can be used by persons older than 14 years old only.
  16. First-time builders should seek advice from people having building experience in order to assemble the model correctly and to produce its performance to full extent.
  17. Take enough safety precautions prior to operation this model.
  18. You are responsible for this model's assembly and safe operation!
  19. Taking out liability insurance is recommended.
1. 请远离正在运行的机件以免擦伤您的手指。
  2. 请不要在人员密集的地方操作模型，请确保旁观者在操作者身后并保持一定的安全距离。
  3. 请远离公共场所，如马路，人员密集区，机场附近或者禁止使用无线电操控的区域，否则会伤及他人或者造成其他无线电设备的信号丢失等现象。
  4. 请确保用充电器给电池充电之前，仔细阅读充电器和电池的说明书，并且谨记锂电池的相关警告语。
  5. 对电池进行充电时，请确保旁边有人。当发现充电器或者电池变烫时，请及时断开电池及充电器。否则会损害充电器以及破坏电池特性以及缩短电池寿命，甚至会造成人身伤害以及财产损失。
  6. 充电过程中请勿堵住或盖住充电器的通风（散热）口，否则会造成充电器过热保护，因而需重新启动充电器。
  7. 不要让杂质，尘埃，水等其他物质进入电调等电子设备，这可能引起短路或者其他伤害。
  8. 请在开始前打开遥控器开关，结束后最后关闭遥控器开关。
  9. 电调在遥控器打开后才开，遥控器关闭前关闭。
  10. 请在下一轮的使用前确保马达和电调已经冷却。
  11. 请不要在电池电压过低的情况下操控模型，这样可能造成摩托车失控或损坏电池。
  12. 在不用的情况下请将电池从模型车中取出。
  13. 此产品不是玩具。
  14. 保证产品及相关的配件远离三岁以下的儿童，避免小零件被儿童吞咽，误食。
  15. 这款产品性能非常卓越，适用于14岁以上的玩家。
  16. 第一次安装时，请向有摩托车安装经验的玩家寻求意见，从而保证安装正确，使产品性能得到完全发挥。
  17. 操控摩托车时，安全第一，请仔细阅读相关安全提示。
  18. 用户对安装及操作过程负责。
  19. 推荐购买责任保险。



## RUNNING IN WET CONDITIONS 潮湿条件驱车

1. Although your model is waterproof, extra care is necessary when running in wet conditions; or it may cause serious damage to your model.
2. The transmitter, receiver and ESC are NOT waterproof.
3. Do not operate your model when it is lightning.
4. Keep far away from salt water or contaminated water when operating the model.

1. 即使模型防水，在潮湿雨水条件中驱车仍须特别注意，稍不注意都有可能严重损害模型车。
2. 遥控器、接收机、电子调速器及其它电子设备不防水。
3. 闪电的时候请不要操控您的模型车。
4. 在操控模型的时候请远离盐水、海水或污水区域。

## AFTER RUNNING IN WET CONDITIONS 潮湿条件驱车后注意事项

1. Unplug the battery from the model.
2. Use air-compressor to dry your model.
3. Spray bearings, fasteners, and drive train or similar product.
4. Check bearings, drive train and other components for well operation before next use.

1. 断开电池与摩托车。
2. 用空气压缩机烘干模型。
3. 吹干轴承链条或者类似的部件。
4. 检查轴承，链条和其他部件，以便下次能顺利操作。

## FEATURES 产品特点

- 1/4 Scale, strong and durable anodized aluminum chassis and metal chain driver.
- Revolutionary stability technology ESS (Electronic Stability System).
- Gyro effect governor.
- Monster power system, easy & quick installation and maintenance.
- Selectable RPM suitable for both beginners and experienced player.
- Rear Wheel oil shock absorber.

- 1/4车型，坚固耐用的氧化铝质车架以及金属链条。
- 独创的ESS电子平衡系统。
- 陀螺效应控制板。
- 爆发力强，安装及保养简单快捷。
- 可供选择的电子陀螺仪转速，适合初学者及高级玩家。
- 后轮油压减震器。

## MOTOR GEARING 马达齿轮

		SPUR GEAR	
		67	68
P I N I O N	10	6.70:1	6.80:1
	11	6.09:1	6.18:1
	12	5.58:1	5.66:1
	13	5.15:1	5.23:1

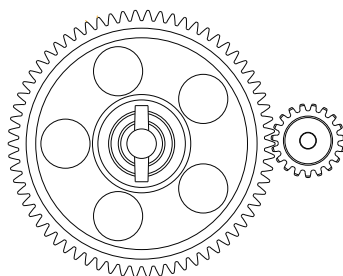

## SPECIFICATION 参数

- Motor: 540 Brushless 3200kv
- ESC: 60A ● 2.4G Radio
- Support 6-8S NiMH / 2-3S LiPo
- Rear Oil Shock Absorber
- Wheel Front: 160mm
- Wheel Rear: 150mm
- High-Torque Servo
- Length: 525mm ● Height: 416mm
- Weight: 3040g

- 马达：540级无刷3200KV
- 电调：60安 ● 2.4G遥控器
- 支持6-8节镍氢电池或2-3节锂电池
- 后轮油压避震器
- 前轮直径：160毫米
- 后轮直径：150毫米
- 高扭力舵机
- 长度：525毫米 ● 高度：416毫米
- 重量：3040克

## ILLUSTRATION OF MAIN PARTS 产品主要部件图示

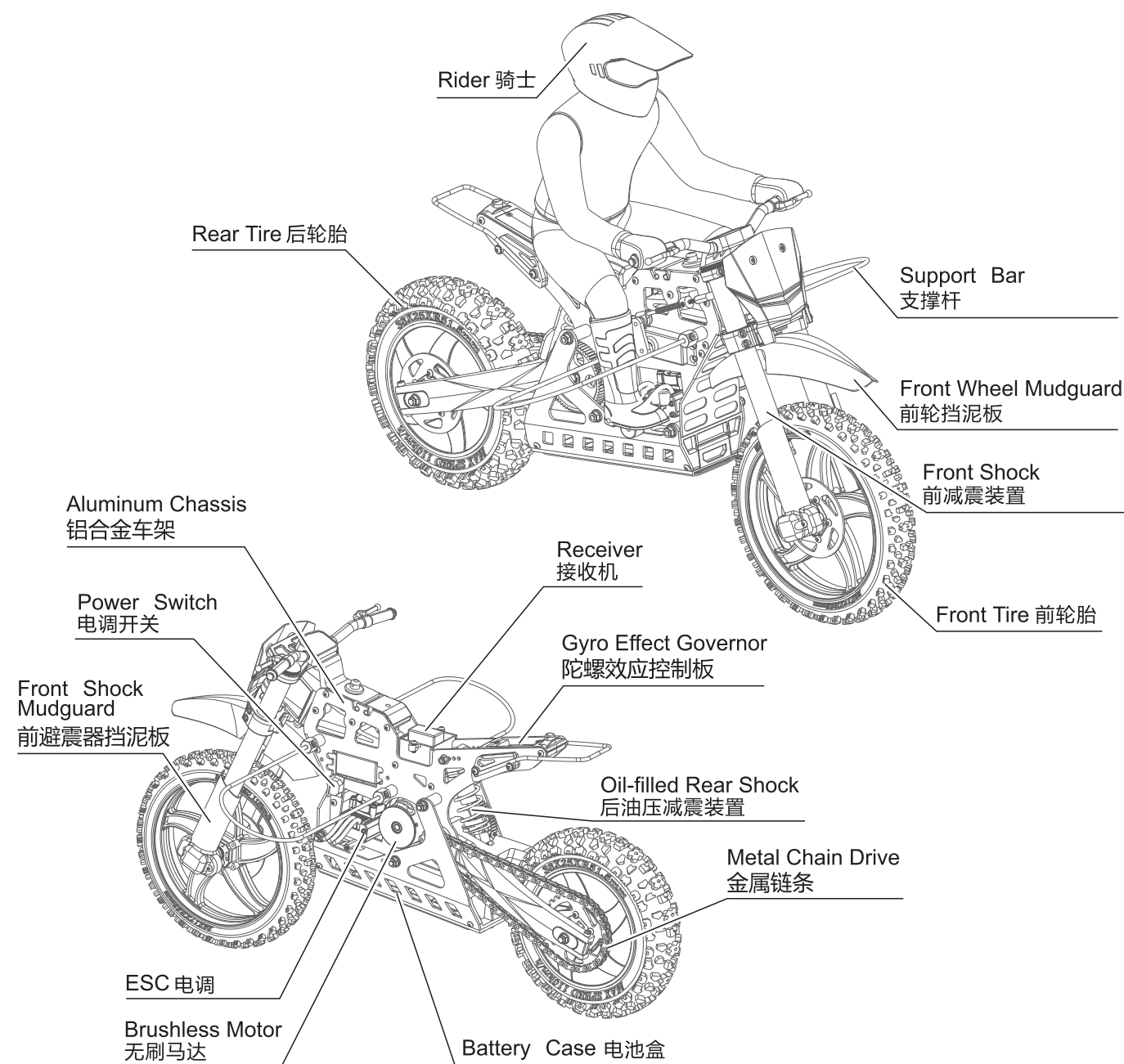



## READY TO RUN PREPARATION 跑前准备工作



This is RTR(Ready to run) version. It is ready to run after user installs the battery, connects ESC and switches on the transmitter and ESC. We suggest the user follow below steps to operate and check the bike for the first use. For future use, user could adjust some settings according to his request.

### Step 1 Check all the parts in the box.

When you open the box, you will find following parts,

1. RC Bike w/ Rider x 1 set
2. Transmitter x1 pc
3. Support Bar x1 pair
4. NiMH Battery (6S, 3000mAh)
5. eN3 Charger
6. 4 AA Battery for Radio
7. Replacement Pack x1 pc

It includes

 RB-A016 Swing Arm A / 摆臂杆A X1PC OR  
 RB-A027 Swing Arm B / 摆臂杆B X1PC

Remark: RB-A016 is used for JR servo and RB-A027 for Futaba servo.

 RB-C006 Adjustment Mount 2 / 调节座2 X2PCS

Remark: Please refer to P24 in Assembly Manual & Part List for usage information.

8. Wrench x2 pcs
9. Pairing wire x1 pc
10. Instruction Manual x1 pc

### Step 2 Install The Support Bar

In order to avoid damage during delivery, SR5 Support Bars of both sides are not installed. Support Bars should be installed before SR5 motorcycle gets ready to run. (For expert rider, support bar is not necessary)

本产品为RTR版本，用户安装好电池（遥控器，摩托车），连接电调，打开遥控器及电调开关，便可使用。第一次使用，建议用户按以下步骤操作并检查整个产品。以后每一次使用之前，用户可根据需要，对相关设置做调整。

### 步骤1 检查包装里的部件

打开包装盒，你会发现以下部件：

1. 摩托车（骑士已安装）1套
2. 遥控器 1个
3. 支撑杆 1对
4. 镍氢电池(6节，3000毫安时)
5. eN3充电器
6. 4节5号电池用于遥控器
7. 配件包 1包

里面包含

 RB-F015 Plug Pad / 塞垫 X1PC

Remark: Please refer to P16 in Assembly Manual & Part List for usage information.

 RB-B042 Stop Screw M5x4 / 止付螺丝M5x4 X8PCS

Remark: They are used to fix the support bars to the bike.

8. 扳手 2把
9. 对码线 1条
10. 说明书 1本

### 步骤2 安装摩托车支撑杆

为避免运输过程中受损，SR5闪电骑士在包装时已将两边支撑杆拆除，用户拆开包装后，找到支撑杆并安装固定好。（熟练车手可以无需使用支撑杆）

Please refer to following steps:

1. Remove the rider and plastic cover.
  - ① Release the screws of both sides which locate at the rider's feet;
  - ② Release the screws of both sides which locate at the bottom of the rider under the plastic cover.
  - ③ Lift the rider and move it to the front of motorcycle;
  - ④ Take off the R clip and remove the cover.
2. Insert ends of the Support Bar to the screw hole (Position A / Position B), tighten the screws and fix with thread lock;
3. Reinstall the rider and the cover.

安装步骤如下：

1. 先将骑士模型以及车壳拆除。
  - ① 松开骑士模型脚底部位置的螺丝；
  - ② 松开骑士底部位于车壳下面的螺丝；
  - ③ 向上板起骑士至摩托车车头位置；
  - ④ 拔出R扣，拆下车壳；
2. 将支撑杆安装到插孔位置，并将每个插孔上的两颗固定螺丝锁紧，并打螺丝胶固定。
3. 将车壳，骑士模型重新安装。

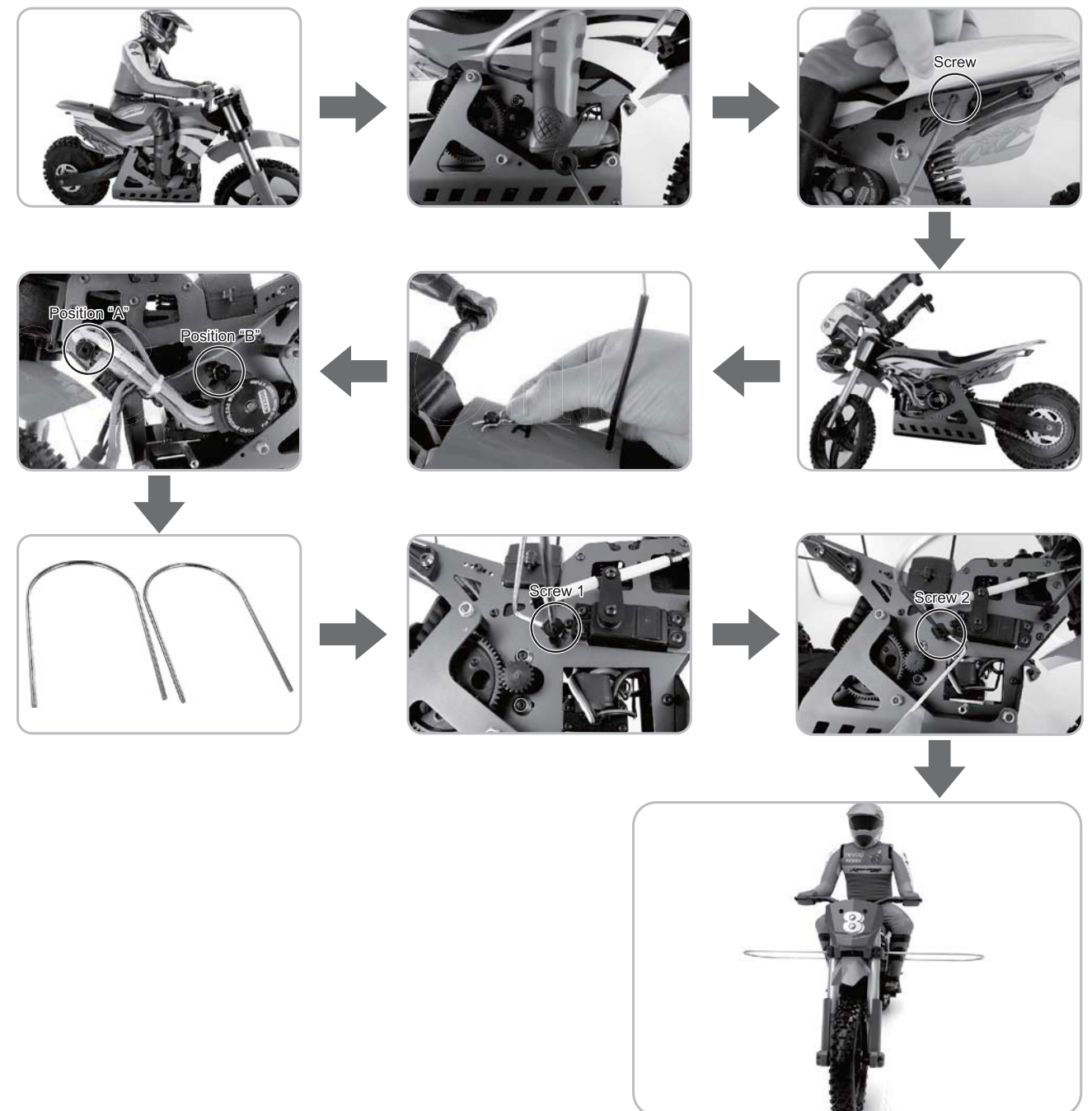

# EXPLODED VIEWS

## 分解图

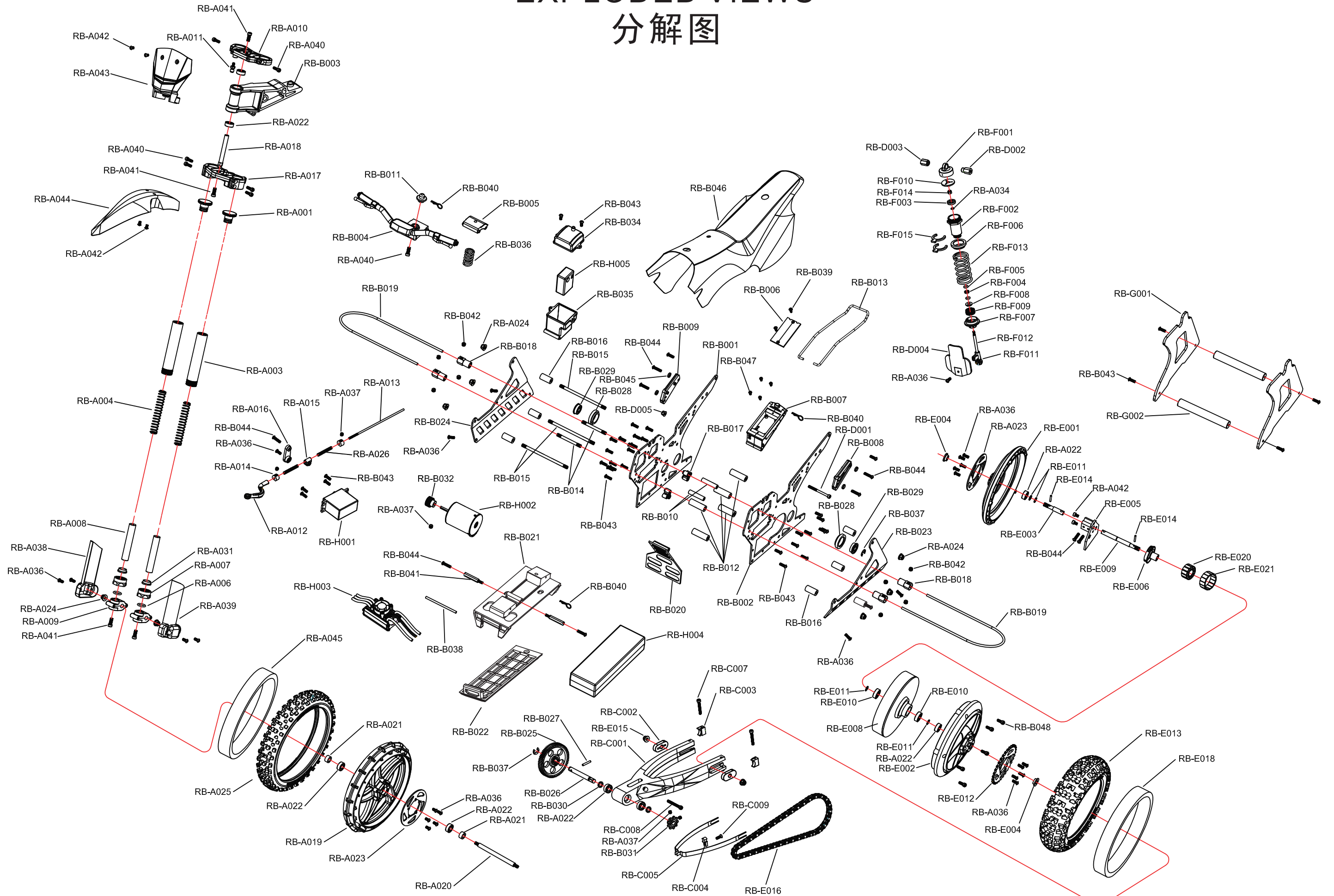



**Step 3 Install batteries to the transmitter and check whether it works properly.**

Note: Make sure the battery is fully charged before installing. Weak power may cause the bike out of control and make damage to the bike, property loss or body damage.

**Step 4 Check the wires are all connected well.**

All the wires are connected well in the factory and we suggest you re-check whether they get loose while delivery before use.

1. The wire between ESC and receiver.
2. The wire between servo and receiver.
3. The wire between ESC and motor.

**Step 5 Install battery to the bike and connect the battery to the ESC**

How to install the battery

1. Remove the R-clip, open the cover of battery case.
2. Install the battery into the battery case.
3. Close the door, secure in place with the R-clip.
4. Connect the battery with the ESC.

- NOTE 1** With the ESC "off", plug the battery into the ESC lead.
- NOTE 2** Please keep the battery wire and the ESC wire in the same side before locking the battery door.
- NOTE 3** Make sure the battery is fully charged before installing. Weak power may cause the bike out of control and make damage to the bike, property loss or body damage.

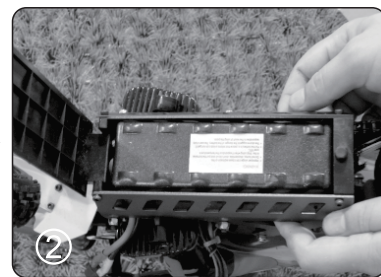
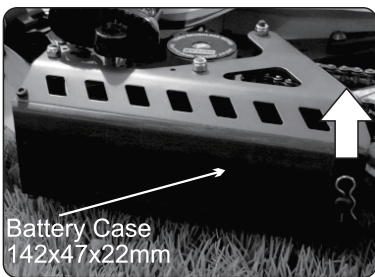

**步骤3 装遥控器电池并检查遥控系统是否正常工作。**

注意：请确保电池充满电。遥控器电池电量不足会引起摩托车车速缓慢，失控，引起财产损失，甚至人身伤害。

**步骤4 检查所有接线是否完好。**

以下接线在出厂时已经全部接好，建议用户使用前再次检查接线在运输途中是否松动。

1. 电子调速器及接收机连接线。
2. 舵机及接收机连接线。
3. 马达及电子调速器连接线。

**步骤5 安装摩托车电池并连接电池和电子调速器。**

如何安装电池？

1. 取出锁扣，打开电池盒盖。
2. 将电池安装至电池盒位置。
3. 合上盒盖，插上锁扣固定。
4. 连接电池和电调。

- 提示1：** 电池连接电调前，保持电调处于关闭状态。
- 提示2：** 固定盒盖前，确认电池硅胶线和电调连接线在同一侧。
- 提示3：** 请确保电池充满电。摩托车电量不足可能引起摩托车性能无法正常发挥。

**Step 6 Set the radio system**

How to set the radio system?

Caution: Calibration is necessary for the first use of the ESC, or whenever used with a new/different transmitter. Different transmitter's signals for full throttle, full brake and neutral varies. You must calibrate your ESC so that it will operate more effectively with you transmitter. Please make sure the ESC is off before setting.

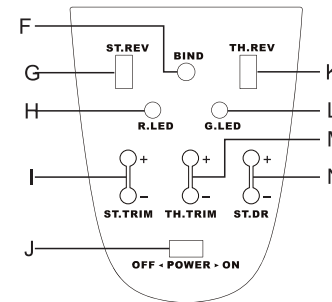
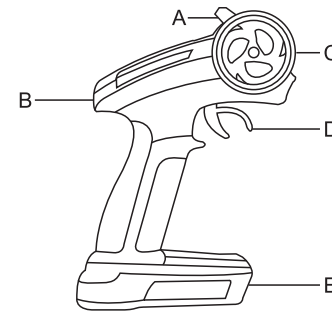

A - Antenna	天线
B - Analog Signal Socket	模拟信号接口
C - Steering Wheel	转向控制
D - Throttle Trigger	油门控制
E - Battery Compartment	电池盒
F - Bind	对码接口
G - ST. REV	方向正反开关
H - Power LED	电源指示灯
I - ST. Trim	转向微调
J - On/Off Switch	电源开关
K - TH. REV	油门正反开关
L - G.LED	电量指示灯
M - TH. Trim	油门微调
N - ST.DR	舵量

1. Switch on the transmitter.
2. Hold full throttle on the transmitter and turn on the ESC switch. Keep holding the full throttle and the motor will ring the initialization tones (All the sounds are played by ESC vibrating the motor).
3. The ESC will detect the battery cells, if the battery pack is 2 cells, it will beep 2 times (Beep-Beep-); if it is 3 cells, it will beep 3 times (Beep-Beep-Beep- )...
4. 3 seconds later, the motor will play one multi-toned ring which indicates the calibration of full throttle is finished.
5. Move the throttle trigger to full brake, the motor will ring like Beep-Beep-Beep (It means the ESC is looking for full brake endpoint), 3 seconds later, the motor will play one multi-toned ring which indicates the calibration of full brake is finished.
6. Relax trigger to neutral (center), the motor will ring like Beep-Beep-Beep (It means the ESC is looking for neutral position), 3 seconds later, the motor will play one multi-toned ring which indicates the calibration of neutral position is finished.
7. 2 seconds later, the motor will play one multi-toned ring. That means the ESC calibration is finished and it is ready to work with transmitter now.



**步骤6 控制系统设置**

如何设置遥控器？

警告：第一次使用电子调速器或者使用新的/不同的遥控器，都必须对电子调速器进行重新校准。不同遥控器油门的正反方向，刹车，油门中立点的信号也不同。为了使电子调速器能有效的的工作，建议你在使用前，重新校准。设定开始之前，请保证电调处于关闭状态。

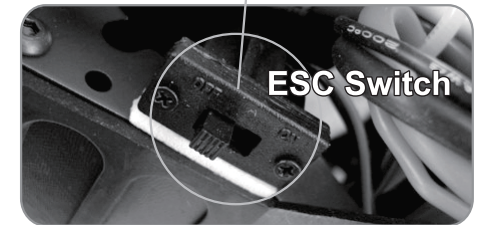

1. 打开遥控器开关。
2. 油门加到最大，持续按住遥控器油门不松开，打开电调开关，马达发出初始音(校准过程所有声音由马达发出)。
3. 电调开始检测电池组节数，如果2节，发出2声“哔哔”，如果3节，则发出3声“哔哔”，以此类推。
4. 3秒钟后，马达发出一串音乐，最大油门校准完毕。
5. 移动油门至最大刹车区域（反向最大区域），马达持续发出“哔哔”（最大刹车点检测中），3秒后，马达发出长串音乐，最大刹车点校准完毕。
6. 松开油门使其回到中立点位置，马达持续发出“哔哔”（油门中立点检测中），3秒后，马达发出长串音乐，油门中立点校准完毕。
7. 2秒后，马达再次发出长串音乐，表示电调校准完成，可以接受遥控器指令。



※ **COUNTER-STEERING SYSTEM**

The SR5 comes with a Counter-Steering System. It means the direction between the transmitter steering wheel and the bike's front wheel are opposite. When the transmitter steering wheel turns left, the front wheel of the bike turns right; when the transmitter steering wheel turns right, the front wheel of the bike turns left.

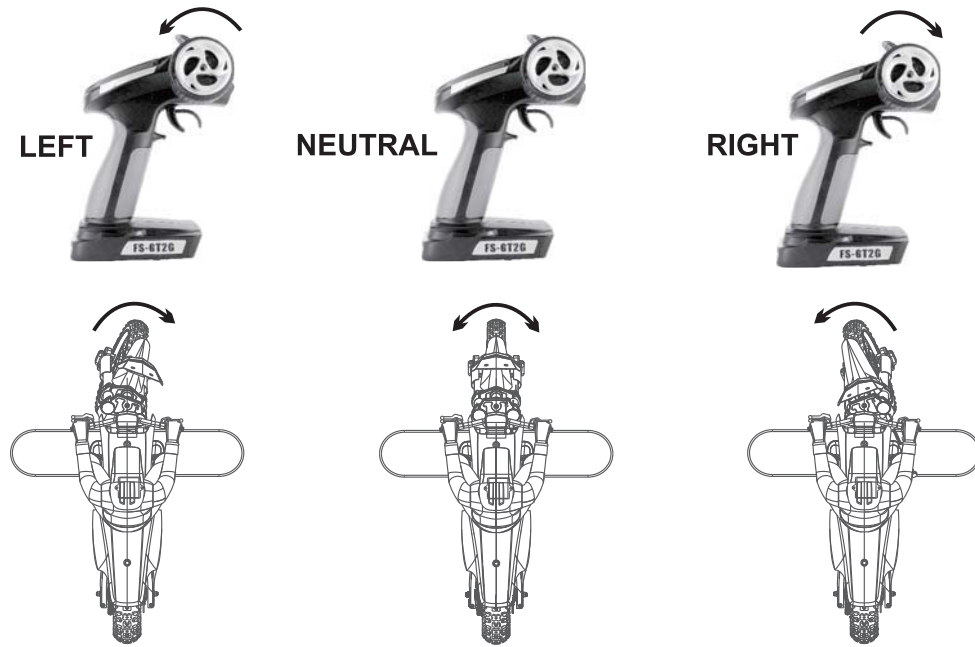

Until now, all the preparation job is finished. The last step is final adjustment. Hold the bike in the air and run the rear wheel, make sure it runs forward.

※ **ELECTRONIC STABILIZING SYSTEM ADJUSTMENT**

The main feature of this bike is its innovative Electronic Stability System(ESS) which built into the rear wheel incorporates a powerful brushless motor and flying wheel which will provide gyro effect for optimal stability. Individual RPM (Rotations Per Minute) setting on the flying wheel can be selected through Gyro Effect Governor Board. High RPM provides optimal stability but less cornering and low RPM provides more maneuverability but less stability. The four kinds of RPM are 8000RPM, 10000RPM, 11000RPM, 12000RPM(factory default). We recommend beginners to run with high RPM.

※ **反向操作系统**

SR5电动摩托车的操作系统是反向的，遥控器的操控轮与摩托车前轮的方向相反。遥控器方向轮控制与摩托车前轮转向方向相反。左转遥控器方向转轮，摩托车前轮右摆；右转遥控器方向转轮，摩托车前轮左摆。

到这一步，所有的准备工作已经完成，最后一步就是最终调试。举起摩托车打开开关使后轮在空中空转，确定其转向向前。

※ **平衡系统·陀螺效应调节**

闪电骑士SR5遥控越野摩托车最主要的特点就是采用先进独创的电子平衡系统 (Electronic Stability System)来保证摩托车在运行过程中的平衡。此系统由陀螺效应控制板和后轮内的电子陀螺部件组成。此系统提供超级稳定的驾驶感觉，并可根据使用者的需求进行调节，初学者可以使用较强的陀螺效应，使车身更加稳定，熟练驾驶后可以降低陀螺效应，提高转弯操控的灵活性。四种可选电子陀螺仪转速为8000RPM, 10000RPM, 11000RPM, 12000RPM (工厂默认设置)。建议初学者选择高转速。

Electronic Gyro RPM adjustment

1. Remove the rider and the plastic cover.
  - 1) Release the screws of both side which locate at the riders' feet .
  - 2) Release the screws of both sides which locate at the bottom of the rider under the plastic cover.
  - 3) Lift the rider and move it to the front of motorcycle.
  - 4) Remove the R-clip, take off the plastic cover from motorcycle.
2. Electronic Gyro RPM adjustment.
  - 1) Release the screws and remove the transparent cover of control box.
  - 2) Press the white Button , choose RPM ( LED flashes with different numbers of beeping sound which indicates users' RPM selection).
- 3) Secure the gyro governor cover with screws.

设置电子陀螺仪转速

1. 拆除骑士模型，及摩托车车壳。
  - 1) 松开骑士脚底部两边螺丝。
  - 2) 松开骑士底部位于车壳下面的螺丝。
  - 3) 向上扳起骑士模型至摩托车头部位置。
  - 4) 拔掉R扣，拆下摩托车车壳。
2. 调节陀螺仪转速值。
  - 1) 松开电子陀螺仪控制盖的螺丝，打开控制盒的透明盖。
  - 2) 通过陀螺仪控制器的按钮调节陀螺仪转速。（选择转速值，对应LED灯闪烁，并伴随不同数量的哔哔声，指示所选转速）

指示灯颜色	转速	声音次数
橙色	8000	1
白色	10000	2
绿色	11000	3
红色	12000	4

- 3) 用螺丝将陀螺仪盖装回去固定。

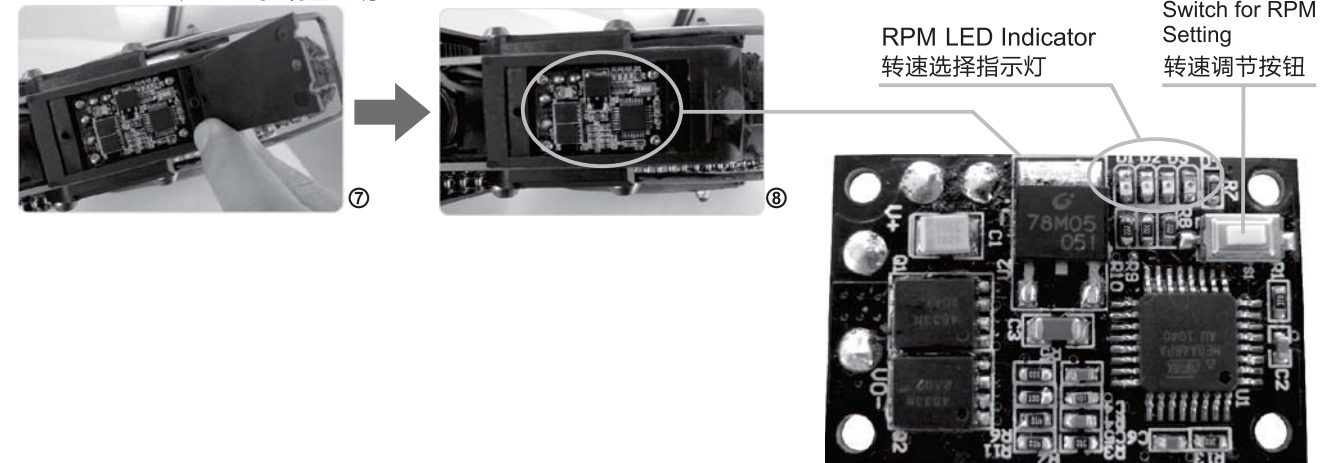
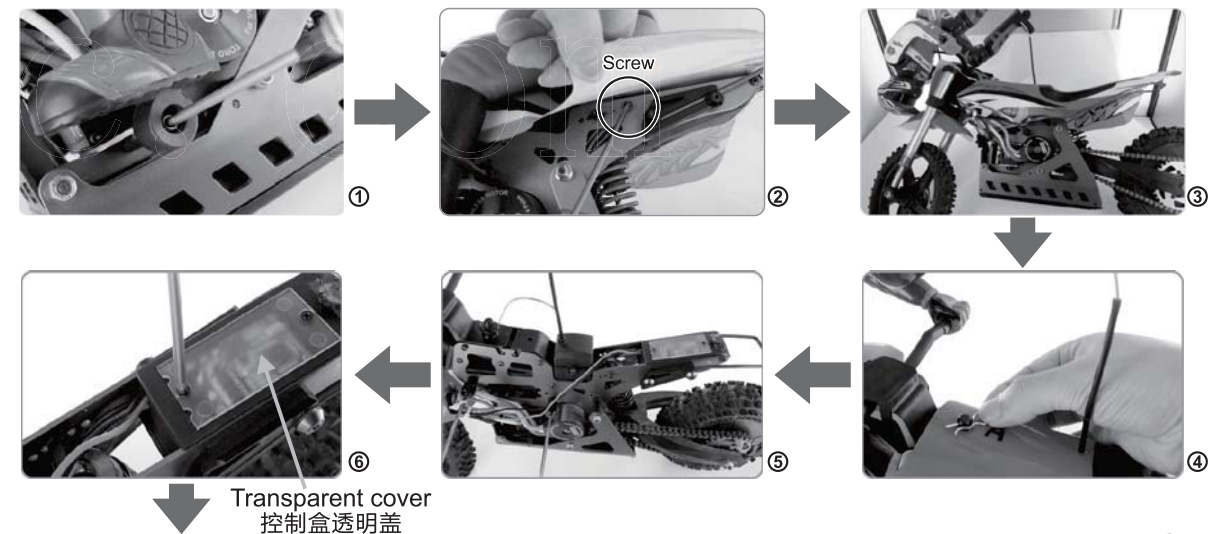



※ PAIR THE RECEIVER WITH THE TRANSMITTER

The RC system of SR5 motorcycle is well paired in the factory and you do not need to pair again. But if you are going to pair the receiver with other transmitter or you need to change a new receiver or transmitter, you have to pair them by yourself.

Please refer to the following steps

1. Install the battery to 2.4G transmitter and power it off.
2. Remove the rider, car shell from the motorbike.
3. Release the screws of the receiver box and take off the cover.
4. Insert the pair line to the BIND port of the receiver.
5. Power on the ESC which will provide power to the receiver and the receiver LED will be flashing at the same time. It means the receiver is ready to pair.
6. Press and hold the bind button on the transmitter, and then switch on the transmitter. The BIND LED of the transmitter should flash, indicating the transmitter is in binding mode.
7. Observe the LED, if the LED of transmitter and receiver changes to solid GREEN and no flash anymore, that means they are successfully paired. (This process is about 5 seconds)
8. Release the bind button on the transmitter and unplug the pair line.
9. If the pair process fails, please go to the first step and pair again.

※ 对码调试

摩托车遥控器出厂前已经完成配对。如需将接收机跟另外的发射机进行配对使用，或者需要更换新的接收器、发射机，请按如下步骤操作。

1. 将2.4G发射机安装好电池，并保持关闭；
2. 拆除摩托车骑士模型、车壳；
3. 松开接收机盒盖固定螺丝，并移开盒盖；
4. 将配对线插入接收机的BIND通道接口；
5. 开启电调给接收机提供电源，此时可看到接收机的LED灯在闪烁，此表示接收机进入配对状态；
6. 将发射机上的对码按键按住，打开发射机电源开关，BIND指示灯闪烁及进入对码配对模式；（注：不要松开按键）
7. 观察LED，如发射机和接收机上的LED都变为绿色并不再闪烁，即配对成功；（注：此过程时间大约为5秒）
8. 松开发射机上的对码按键，拔掉接收机上的配对线，配对完成；
9. 如果配对失败，则重复以上操作步骤。

PRE-RUN CHECKLIST

Note: The built-in electronic gyro will start running once you connect the battery to the ESC and it will come into full effect after 1 minute running.

1. Make sure there is no rocks and small debris in chain and sprocket. Make sure the chain and sprocket moves freely.
2. Make sure the transmitter is ON.
3. Make sure the throttle is in neutral position.
4. Turn off the transmitter AFTER cutting off the power.
5. Make sure the running area is large and free from obstacles and small children. For the beginners we recommend a large open parking lot. Any RC bike will have unique handle characteristics that you need to understand before pushing the bike to the extreme.

**CAUTION**

Before you power on the bike, please make sure the bike stand is not on metal or conductive surface, it may cause short circuit and the ESC and gyro may get burnt.

跑前检查

注意：一旦连上电池及电调，内置陀螺仪即开始运转，电子陀螺效应开始启动，请等候一分钟，使陀螺效应达到最大效果。

1. 请检查链条及链轮上没有小石头及其他碎片，保证链条及链轮能运行自如。
2. 遥控器保持开启状态。
3. 确保油门，方向在中位位置。
4. 关闭系统时，先切断动力电源，再关闭遥控器。
5. 请远离儿童并在空旷区域操作，对于初学者我们建议去空旷的开放型停车区。任何遥控器的手柄都有独特的特征，在全力驱车前请了解清楚并熟悉操作。

**警告**

摩托车通电之前，请确定摩托车后轮固定支架没有放在金属或者易导电材质的桌面上，以免短路造成陀螺仪启动电调烧坏。

Until this step the bike is ready to run.

到这里，所有的安装调试、检查过程全部完成

HELPFUL HINTS FOR ASSEMBLY 安装提示

1. Avoid working on a deep pile carpet. It is difficult to find some small components, such as screw, if you drop them into it.
2. To prevent parts from rolling off and protect the working surface, you could put all the small parts into a container.
3. Avoid running the bike in cold weather. Low temperature may cause plastic and metal parts brittle. What's more, the grease and oil become thick which may cause poor performance.
4. Test fit all parts before attaching them to the bike.

1. 尽量不要在长毛地毯上操作摩托车，如果零配件，例如螺丝，掉进地毯，很难找到。
2. 为了不让零件滚落，最好将所有部件放在容器里。
3. 尽量避免在天冷的时候操作摩托车。低温会引起塑料机金属部件会变脆，容易折断。而油也会变浑浊，影响摩托车性能。
4. 在固定各部件之前，请确保各部件之间完全吻合。

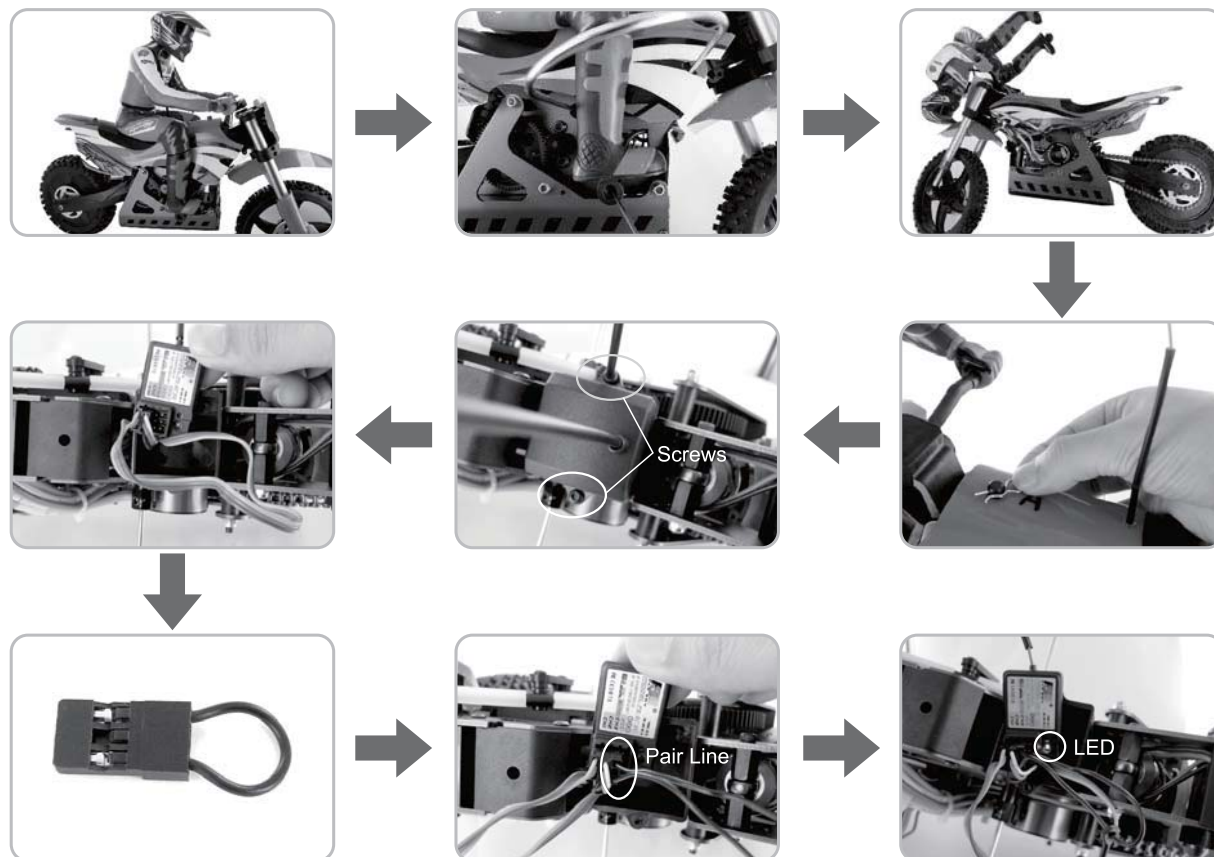

## CHARGE PROCEDURES 电池充电操作

SKYRC eN3 comes with the built in power supply. You can connect the AC power cord to the AC socket (100-240V AC) directly. Please refer to following steps to charge the battery.

- 1) Insert the AC power cord into the charger.
- 2) Insert the AC cord into a wall socket (100-240V). The charge status LED will light for 1 second and then flash green which indicates the charger is ready for charging.
- 3) Select the proper charging current 1A/2A/3A by the toggle switch.

*How to calculate the charge time?*

Charge Time (mins) = Battery Capacity (Ah) / Charge Current (A)

Capacity	Charge Current	Approximate Charge Time
3000mAh	1A	180 mins.
	2A	90 mins.
	3A	60 mins.

- 4) Connect battery lead to charger's battery socket.
- 5) The charger starts charging. The charge status LED will glow constant red.
- 6) When the battery is fully charged, the charge status LED will glow constant green.
- 7) Unplug the battery from the charger and the charge status LED will flash green which indicates the charger is ready to charge another battery.

### EXPLANATION OF LED STATUS

LED STATUS	CHARGE STATUS
LED Flashes Green	The Charger is Ready
LED Glows Red	Battery Charging in Process
LED Glows Green	Battery is Fully Charged

### \* Error Message

The charge current can't be changed during charging process. If you change it, the charge status LED will flash red to alert you to the error. In this case, please disconnect the power cord from the wall socket and unplug the battery from the charger. You need to restart the charger to make it work again.

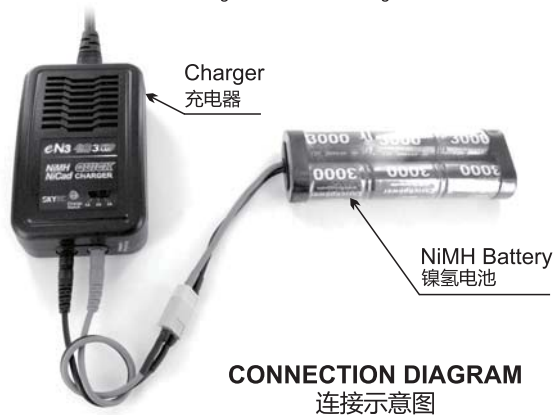

SKYRC eN3内置适配器,可直接通过电源线连接插座,

请参考如下步骤:

- 1) 将充电器与AC电源线连接。
- 2) 将AC电源线插入电压为100-240V的壁式插座, 充电状态LED指示灯将会亮一秒, 接着绿灯闪表示充电器进入待机状态。
- 3) 拨动开关选择合适的充电电流: (1A/2A/3A)

*如何计算充电时间?*

充电时间(分钟) = 电池容量(安时) / 充电电流(安)

容量	充电电流	预计充电时间
3000mAh	1A	60 mins.
	2A	90 mins.
	3A	60 mins.

- 4) 按以下图示将充电器与电池连接。
- 5) 充电状态LED指示灯, 红灯常亮, 充电器开始工作。
- 6) 充电状态LED指示灯, 绿灯常亮, 充电完成。
- 7) 拔掉电池后, 充电状态LED指示灯绿灯闪, 表示充电器进入待机状态。

### LED指示灯状态说明

LED指示灯状态	充电状态
绿灯闪	待机
红灯常亮	正在充电
绿灯常亮	充电完成

### \* 报错提示

在充电过程中不能更改充电电流, 如果更改, 充电状态LED指示灯将会闪红灯提示错误。在这种情况下, 请拔掉电源, 然后再将充电器与电池断开。您需要重启充电器后再使用。

### CAUTION:

This diagram shows the correct way to connect your battery to the eN3 charger while charging. Failure to connect as shown in this diagram will damage this charger.

### 注意

请按照左图正确连接充电器和电池, 不当的连接方法, 将会损坏充电器和电池!

## TROUBLE SHOOTING 疑难解答

Problem 1 The motorbike does not move.

Cause

- 1) Battery in motorbike or transmitter is no power.
- 2) Motor may be broken.
- 3) ESC does not work.
- 4) The setting of transmitter or ESC may be wrong.

Problem 2 The model is out of control.

Cause

- 1) Transmitter or antenna may be broken.
- 2) The motorbike may be out of range from transmitter.
- 3) Power of the transmitter is weak or dead.

Problem 3 Short run time.

Cause

- 1) Battery may be damaged.
- 2) Charger may be damaged.
- 3) Battery is not with full power.

Problem 4 Poor performance of the motorbike.

Cause

- 1) Suspension may not run freely.
- 2) The steering may be damaged.
- 3) Chain may be too loose or too tight.
- 4) Rear wheel may not adjust straight.

1. 问题: 摩托车没有动力。

原因分析:

- 1) 摩托车电池或者遥控器电池损坏。
- 2) 马达损坏。
- 3) 电调不工作。
- 4) 遥控或电调设置错误。

2. 问题: 摩托车不受控制。

原因分析:

- 1) 遥控器或天线损坏。
- 2) 摩托车跑出遥控器控制范围。
- 3) 遥控器没电或电池电量不足。

3. 问题: 摩托车跑动时间短。

原因分析:

- 1) 电池可能损坏。
- 2) 充电器可能损坏。
- 3) 电池未充饱。

4. 问题: 摩托车性能低。

原因分析:

- 1) 避震器缓冲功能存在问题。
- 2) 舵机损坏。
- 3) 摩托车链条过松, 或过紧。
- 4) 后轮方向未调整正确。

## WARRANTY 保修条款

Each kit is inspected and adjusted carefully before leaving our factory and we guarantee the kit be free of material defects and workmanship faults. We will repair the kit for customer free of charge within 90 days after the purchase date.

The warranty doesn't cover crash damage, modification, failure to maintenance, or the damaged caused by improper use.

The warranty doesn't cover any result which caused by final user's assembly or the material used for final user's assembly.

每辆摩托车出厂之前都经过严格的测试及调试, 我公司保证, 客户购买的产品打开包装后, 无任何材料及工艺方面的问题。购买之日90天内, 我公司将免费为客户维修。

由于碰撞, 翻车, 用户自行更改配置, 疏于保养或者任何不当使用引起的损坏, 将不在保修范围内。

由终端用户自行安装或自行安装所使用的材料所引起的任何问题, 亦不属于保修范围。

## OPTIONAL PARTS 升级件



RB-A010 SK-700002-56  
Aluminum Front Upper Suspension Mount  
金属上固定板



RB-A017 SK-700002-57  
Aluminum Lower Upper Suspension Mount  
金属下固定板



RB-B003 SK-700002-58  
Aluminum Chassis Connector  
金属车架连接头



RB-B013 SK-700002-59  
Aluminum Rear Chassis Brace  
金属尾架升级件

Please download the Assembly Manual & Part List from our website:

请登录SKYRC网站下载详细安装说明及配件图:

<http://www.skyrc.com>